



SANYO Semiconductors

DATA SHEET

An ON Semiconductor Company

NPN Epitaxial Planar Silicon Transistor

55GN01MA — UHF Wide-band Low-noise Amplifier Applications

Features

- High cut-off frequency : $f_T=5.5\text{GHz typ}$
- High gain : $|S_{21e}|^2=10\text{dB typ (}f=1\text{GHz)}$

Specifications

Absolute Maximum Ratings at $T_a=25^\circ\text{C}$

Parameter	Symbol	Conditions	Ratings	Unit
Collector-to-Base Voltage	V_{CBO}		20	V
Collector-to-Emitter Voltage	V_{CEO}		10	V
Emitter-to-Base Voltage	V_{EBO}		3	V
Collector Current	I_C		70	mA
Collector Dissipation	P_C	When mounted on ceramic substrate (250mm ² x0.8mm)	400	mW
Junction Temperature	T_j		150	°C
Storage Temperature	T_{stg}		-55 to +150	°C

Package Dimensions

unit : mm (typ)

7023A-009

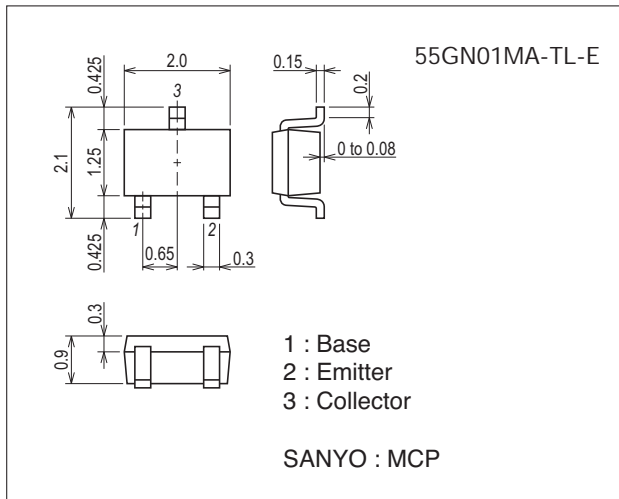

Product & Package Information

- Package : MCP
- JEITA, JEDEC : SC-70, SOT-323
- Minimum Packing Quantity : 3,000 pcs./reel

Packing Type: TL

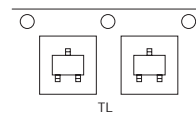

Marking

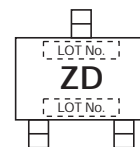

Electrical Connection

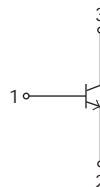

55GN01MA

Electrical Characteristics at Ta=25°C

Parameter	Symbol	Conditions	Ratings			Unit
			min	typ	max	
Collector Cutoff Current	I_{CBO}	$V_{CB}=10V, I_E=0A$			0.1	μA
Emitter Cutoff Current	I_{EBO}	$V_{EB}=2V, I_C=0A$			1	μA
DC Current Gain	h_{FE}	$V_{CE}=5V, I_C=10mA$	100		180	
Gain-Bandwidth Product	f_{T1}	$V_{CE}=3V, I_C=5mA$	3.0	4.5		GHz
	f_{T2}	$V_{CE}=5V, I_C=20mA$		5.5		GHz
Output Capacitance	C_{ob}	$V_{CB}=10V, f=1MHz$		1.0	1.3	pF
Reverse Transfer Capacitance	C_{re}			0.6		pF
Forward Transfer Gain	$ S_{21e} ^2$	$V_{CE}=5V, I_C=20mA, f=1GHz$	7	10		dB
Noise Figure	NF	$V_{CE}=3V, I_C=5mA, f=1GHz, Z_O=50\Omega$		1.9	2.8	dB

Ordering Information

Device	Package	Shipping	memo
55GN01MA-TL-E	MCP	3,000pcs./reel	Pb Free

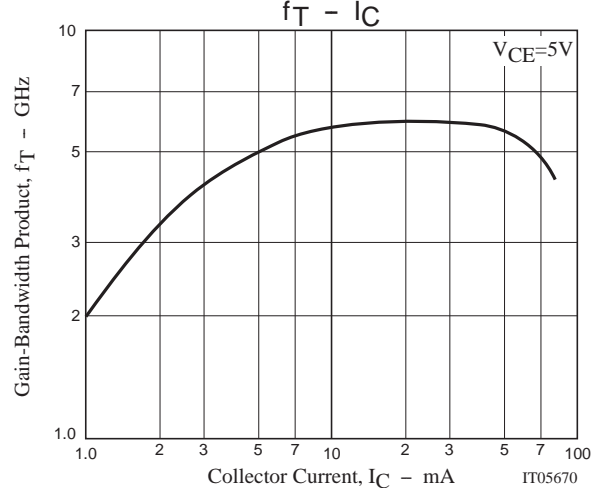
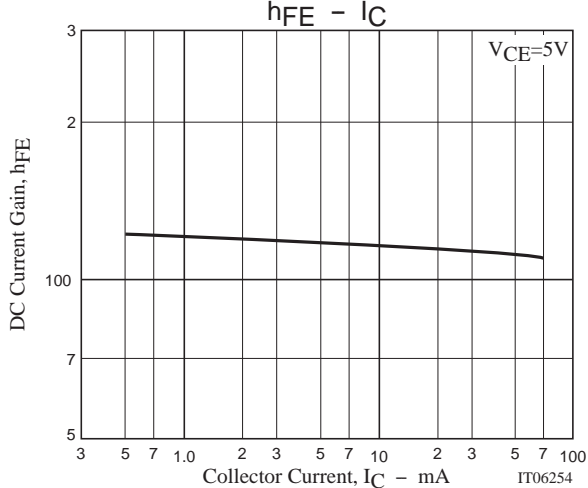
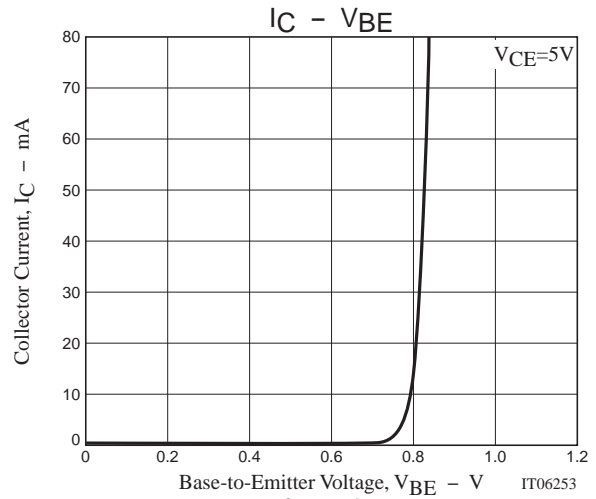
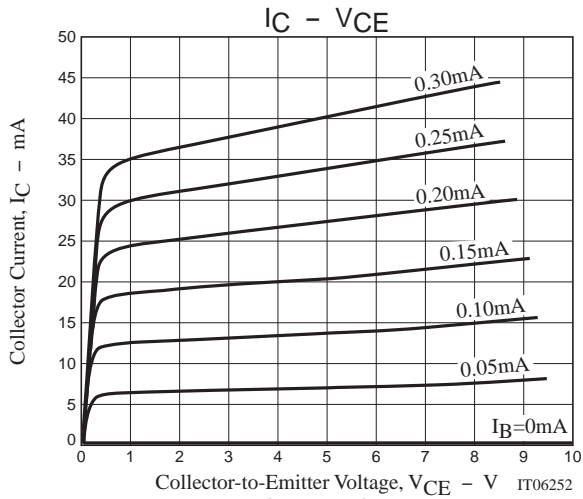

55GN01MA

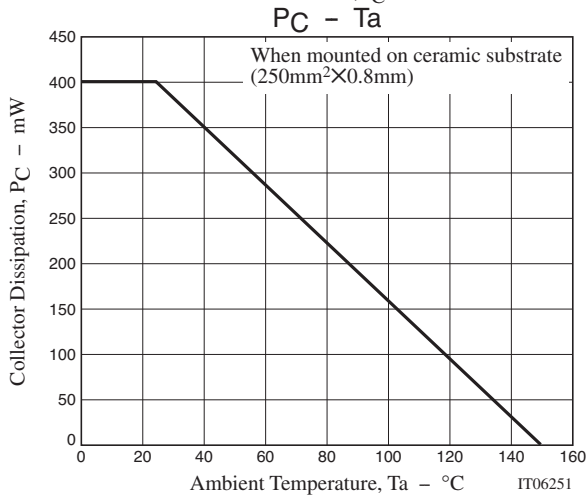
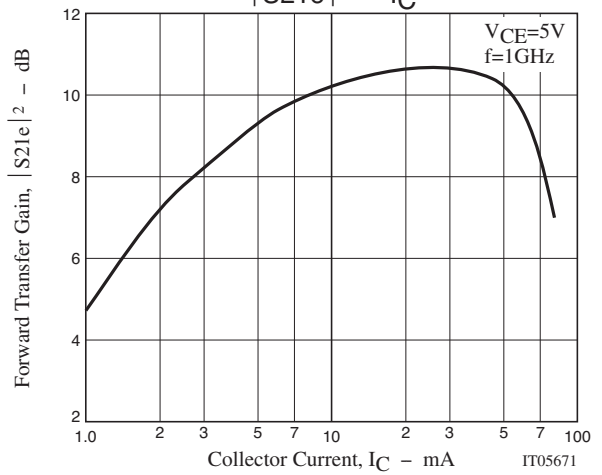
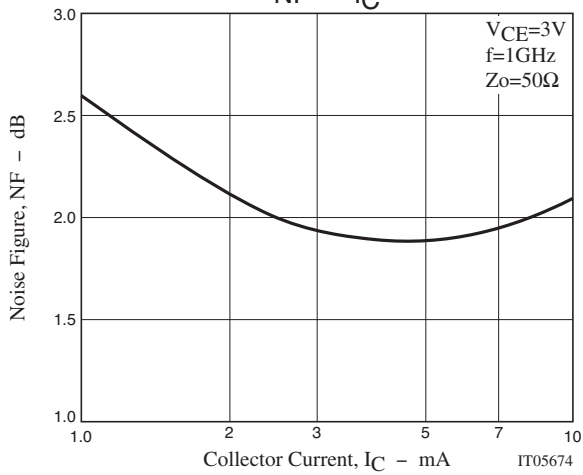
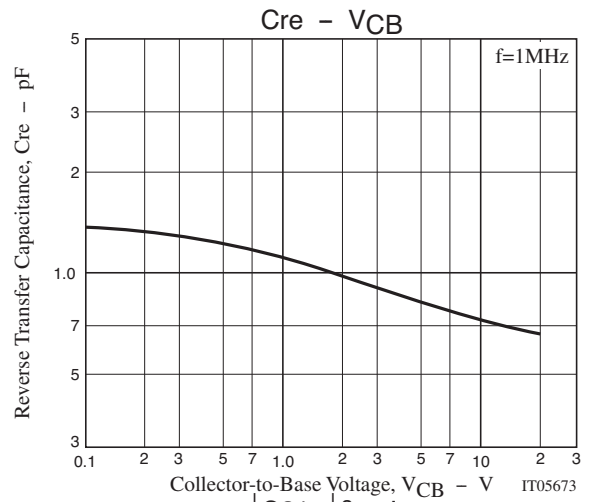
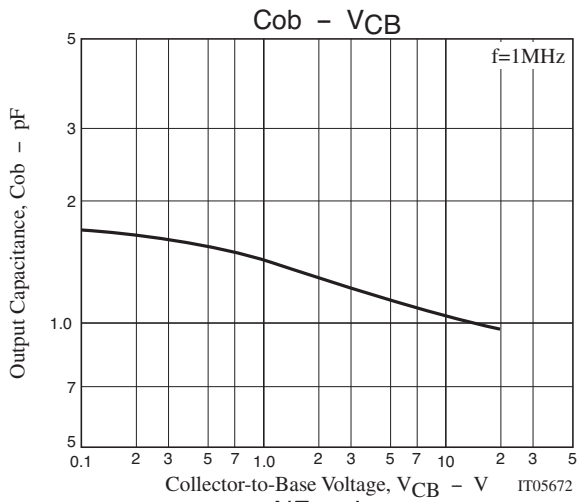

55GN01MA

S Parameters (Common emitter)

$V_{CE}=5V, I_C=5mA, Z_O=50\Omega$

Freq(MHz)	S11	$\angle S11$	S21	$\angle S21$	S12	$\angle S12$	S22	$\angle S22$
100	0.830	-43.97	13.127	147.99	0.038	67.23	0.872	-22.91
200	0.694	-77.62	10.294	125.90	0.060	54.39	0.700	-35.46
400	0.540	-117.92	6.419	101.76	0.081	48.13	0.501	-44.05
600	0.481	-140.06	4.518	88.76	0.095	49.82	0.424	-46.75
800	0.461	-155.07	3.503	78.58	0.111	52.28	0.393	-49.83
1000	0.451	-165.52	2.877	70.19	0.128	54.96	0.381	-53.19
1200	0.445	-174.34	2.452	62.66	0.146	56.81	0.375	-57.17
1400	0.445	178.04	2.147	56.03	0.168	58.15	0.377	-61.74
1600	0.445	171.32	1.918	49.61	0.189	58.43	0.382	-66.69
1800	0.445	164.86	1.737	43.71	0.211	58.38	0.386	-71.55
2000	0.449	158.60	1.595	38.11	0.237	58.17	0.390	-76.75
2200	0.452	152.58	1.467	32.97	0.265	57.40	0.396	-82.35
2400	0.450	146.68	1.363	28.29	0.289	56.02	0.399	-87.23
2600	0.453	141.54	1.274	24.12	0.315	55.05	0.402	-92.59
2800	0.462	136.46	1.198	20.67	0.346	53.73	0.407	-98.30
3000	0.472	131.80	1.143	17.49	0.377	51.74	0.405	-104.52

$V_{CE}=5V, I_C=10mA, Z_O=50\Omega$

Freq(MHz)	S11	$\angle S11$	S21	$\angle S21$	S12	$\angle S12$	S22	$\angle S22$
100	0.684	-64.81	20.386	135.46	0.033	61.46	0.746	-32.56
200	0.537	-103.63	13.552	113.26	0.046	54.93	0.530	-42.92
400	0.442	-139.55	7.523	93.84	0.066	56.90	0.365	-45.97
600	0.418	-156.47	5.145	83.67	0.087	60.27	0.318	-46.89
800	0.415	-167.86	3.934	75.21	0.109	62.42	0.302	-49.45
1000	0.412	-175.67	3.211	67.90	0.131	63.30	0.299	-52.76
1200	0.411	177.29	2.725	61.28	0.155	63.24	0.299	-56.97
1400	0.415	171.08	2.375	55.21	0.179	62.62	0.304	-61.81
1600	0.418	165.63	2.121	49.25	0.203	61.52	0.311	-66.89
1800	0.419	159.97	1.918	43.74	0.228	60.43	0.315	-71.68
2000	0.424	154.44	1.760	38.40	0.254	58.94	0.320	-76.83
2200	0.429	148.97	1.619	33.44	0.281	57.20	0.326	-82.56
2400	0.427	143.60	1.506	28.88	0.304	55.14	0.329	-86.87
2600	0.431	139.13	1.408	24.76	0.329	53.64	0.334	-92.16
2800	0.441	134.54	1.327	21.16	0.358	51.96	0.339	-97.67
3000	0.451	130.40	1.266	17.89	0.386	49.84	0.338	-103.91

$V_{CE}=5V, I_C=20mA, Z_O=50\Omega$

Freq(MHz)	S11	$\angle S11$	S21	$\angle S21$	S12	$\angle S12$	S22	$\angle S22$
100	0.527	-90.16	26.224	123.28	0.026	59.94	0.598	-40.43
200	0.438	-127.59	15.340	104.33	0.037	60.44	0.396	-45.63
400	0.399	-155.68	8.065	89.00	0.060	65.69	0.282	-44.29
600	0.393	-167.56	5.453	80.60	0.084	67.76	0.256	-44.57
800	0.397	-176.18	4.149	73.14	0.109	68.31	0.250	-47.52
1000	0.398	177.84	3.379	66.41	0.134	67.71	0.252	-51.39
1200	0.401	172.13	2.862	60.19	0.159	66.77	0.255	-55.96
1400	0.406	166.95	2.491	54.45	0.186	65.32	0.262	-61.04
1600	0.411	162.22	2.222	48.82	0.210	63.20	0.270	-66.49
1800	0.414	157.06	2.008	43.51	0.235	61.52	0.275	-71.29
2000	0.419	152.07	1.840	38.32	0.261	59.51	0.282	-76.53
2200	0.425	146.91	1.693	33.45	0.288	57.59	0.289	-82.27
2400	0.424	141.87	1.574	29.00	0.312	55.28	0.293	-86.65
2600	0.429	137.61	1.472	24.92	0.336	53.54	0.298	-91.76
2800	0.438	133.38	1.387	21.39	0.365	51.63	0.304	-97.07
3000	0.449	129.47	1.321	18.07	0.392	49.39	0.303	-103.60

55GN01MA

S Parameters (Common emitter)

$V_{CE}=5V$, $I_C=30mA$, $Z_O=50\Omega$

Freq(MHz)	S11	$\angle S11$	S21	$\angle S21$	S12	$\angle S12$	S22	$\angle S22$
100	0.461	-105.76	28.111	117.59	0.023	60.62	0.521	-42.88
200	0.412	-139.73	15.717	100.76	0.034	64.40	0.344	-44.71
400	0.393	-162.64	8.133	87.05	0.058	69.84	0.255	-41.81
600	0.394	-172.24	5.483	79.25	0.084	70.67	0.237	-42.42
800	0.400	-179.58	4.169	72.10	0.110	70.59	0.235	-45.80
1000	0.401	175.18	3.392	65.52	0.135	69.45	0.239	-49.94
1200	0.405	169.95	2.870	59.47	0.161	68.00	0.244	-54.75
1400	0.412	165.14	2.496	53.81	0.187	66.24	0.252	-60.09
1600	0.417	160.67	2.226	48.20	0.212	64.03	0.260	-65.80
1800	0.422	155.72	2.010	42.96	0.237	62.33	0.267	-70.89
2000	0.428	150.84	1.841	37.78	0.263	60.20	0.275	-76.12
2200	0.434	145.91	1.692	32.98	0.291	58.16	0.282	-81.97
2400	0.433	140.96	1.574	28.60	0.314	55.69	0.286	-86.52
2600	0.438	136.73	1.469	24.51	0.339	53.89	0.291	-91.68
2800	0.447	132.49	1.384	21.02	0.367	52.12	0.298	-97.10
3000	0.459	128.65	1.319	17.72	0.395	49.72	0.298	-103.63

55GN01MA

Outline Drawing 55GN01MA-TL-E

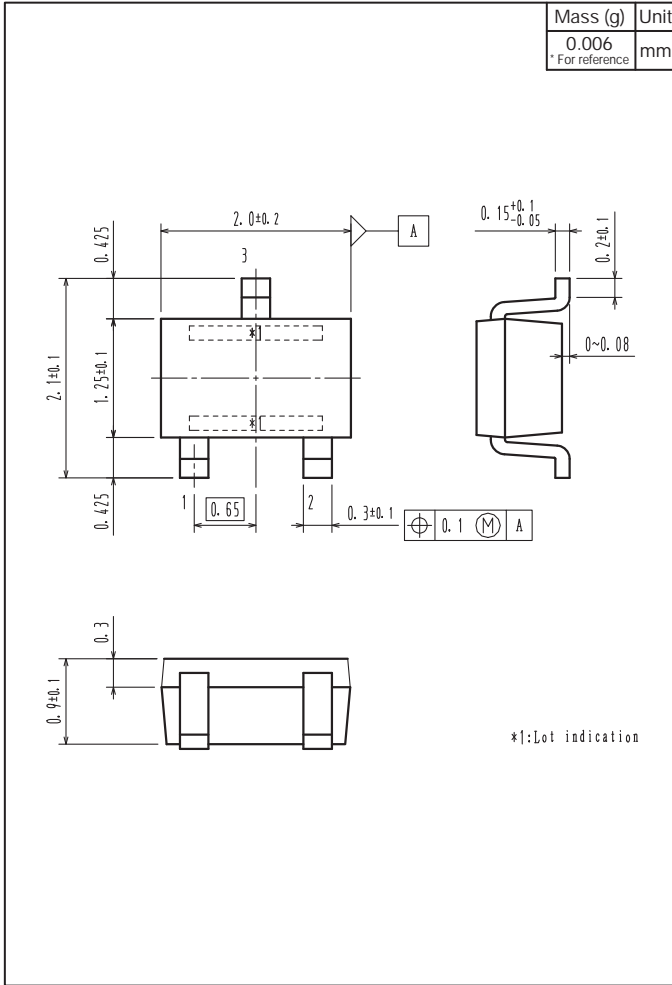

Land Pattern Example

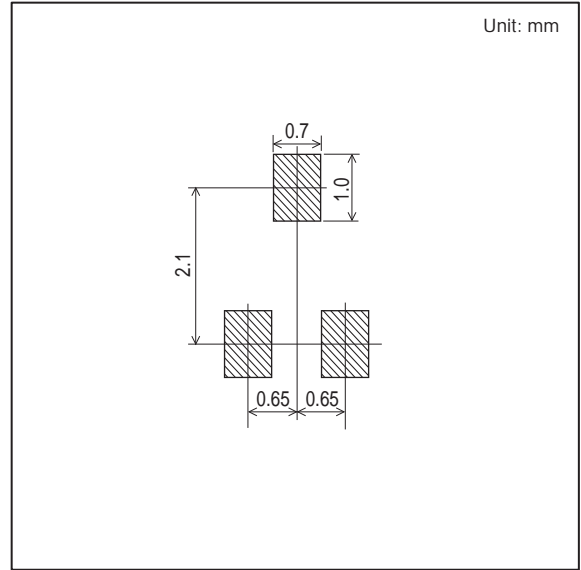

- Any and all SANYO Semiconductor Co.,Ltd. products described or contained herein are, with regard to "standard application", intended for the use as general electronics equipment. The products mentioned herein shall not be intended for use for any "special application" (medical equipment whose purpose is to sustain life, aerospace instrument, nuclear control device, burning appliances, transportation machine, traffic signal system, safety equipment etc.) that shall require extremely high level of reliability and can directly threaten human lives in case of failure or malfunction of the product or may cause harm to human bodies, nor shall they grant any guarantee thereof. If you should intend to use our products for new introduction or other application different from current conditions on the usage of automotive device, communication device, office equipment, industrial equipment etc. , please consult with us about usage condition (temperature, operation time etc.) prior to the intended use. If there is no consultation or inquiry before the intended use, our customer shall be solely responsible for the use.
- Specifications of any and all SANYO Semiconductor Co.,Ltd. products described or contained herein stipulate the performance, characteristics, and functions of the described products in the independent state, and are not guarantees of the performance, characteristics, and functions of the described products as mounted in the customer's products or equipment. To verify symptoms and states that cannot be evaluated in an independent device, the customer should always evaluate and test devices mounted in the customer's products or equipment.
- SANYO Semiconductor Co.,Ltd. assumes no responsibility for equipment failures that result from using products at values that exceed, even momentarily, rated values (such as maximum ratings, operating condition ranges, or other parameters) listed in products specifications of any and all SANYO Semiconductor Co.,Ltd. products described or contained herein.
- Regarding monolithic semiconductors, if you should intend to use this IC continuously under high temperature, high current, high voltage, or drastic temperature change, even if it is used within the range of absolute maximum ratings or operating conditions, there is a possibility of decrease reliability. Please contact us for a confirmation.
- SANYO Semiconductor Co.,Ltd. strives to supply high-quality high-reliability products, however, any and all semiconductor products fail or malfunction with some probability. It is possible that these probabilistic failures or malfunction could give rise to accidents or events that could endanger human lives, trouble that could give rise to smoke or fire, or accidents that could cause damage to other property. When designing equipment, adopt safety measures so that these kinds of accidents or events cannot occur. Such measures include but are not limited to protective circuits and error prevention circuits for safe design, redundant design, and structural design.
- In the event that any or all SANYO Semiconductor Co.,Ltd. products described or contained herein are controlled under any of applicable local export control laws and regulations, such products may require the export license from the authorities concerned in accordance with the above law.
- No part of this publication may be reproduced or transmitted in any form or by any means, electronic or mechanical, including photocopying and recording, or any information storage or retrieval system, or otherwise, without the prior written consent of SANYO Semiconductor Co.,Ltd.
- Any and all information described or contained herein are subject to change without notice due to product/technology improvement, etc. When designing equipment, refer to the "Delivery Specification" for the SANYO Semiconductor Co.,Ltd. product that you intend to use.
- Upon using the technical information or products described herein, neither warranty nor license shall be granted with regard to intellectual property rights or any other rights of SANYO Semiconductor Co.,Ltd. or any third party. SANYO Semiconductor Co.,Ltd. shall not be liable for any claim or suits with regard to a third party's intellectual property rights which has resulted from the use of the technical information and products mentioned above.

This catalog provides information as of July, 2012. Specifications and information herein are subject to change without notice.