

DETAILS

Product Number	C10923_GT4-W
Family	Gt4
Type	Lens array
Color	clear
Diameter	35 mm
Height	9 mm
Style	round
Optic Material	PMMA
Holder Material	
Fastening	pin, glue
Status	production ready
ROHS Compliant	Yes
Date Updated	8/03/2014



OPTICAL PROPERTIES

LED	Viewing	Light	Effi-		Connector
	Angle	Beam	ciency	cd/lm	
XP-E	37 deg	Wide	87 %	1.670	-
XP-G	45 deg	Wide	87 %	1.200	-
XB-D	36 deg	Wide	91 %	1.610	-
LUXEON Rebel ES	33 deg	Wide	89 %	2.020	-
LUXEON A	41 deg	Wide	-	-	-
Oslo SSL 80	33 deg	Wide	91 %	1.700	-
Oslo SSL 150	36 deg	Wide	87 %	1.780	-
Synios P2720 1/4 mm	sim: 33	Wide	sim: 94 %	sim: 2.100	-
Z5	sim: 36	Wide	-	-	-
Double Dome (GM2BB)	42 deg	Wide	-	-	-

D

C

B

A

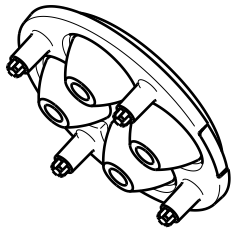

Isometric view
Scale: 1:1

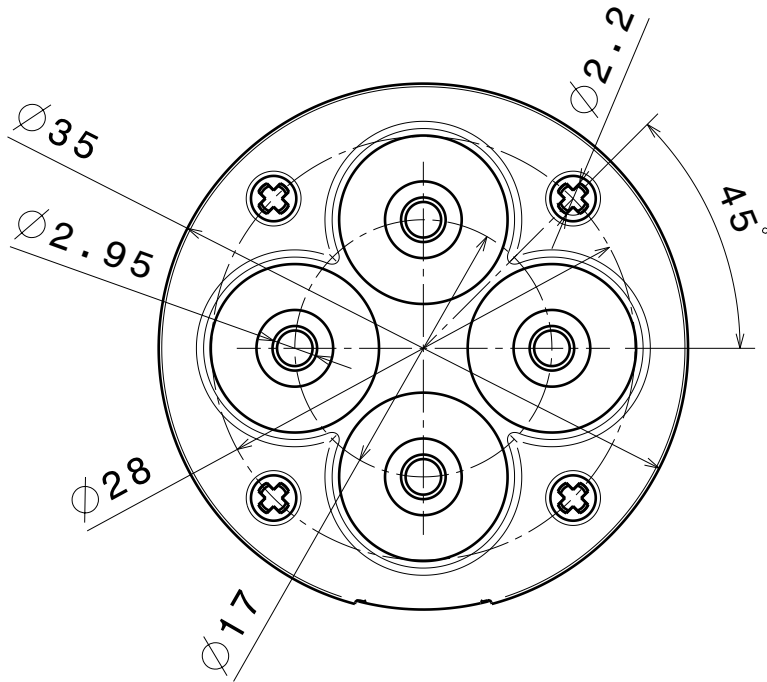

Bottom view

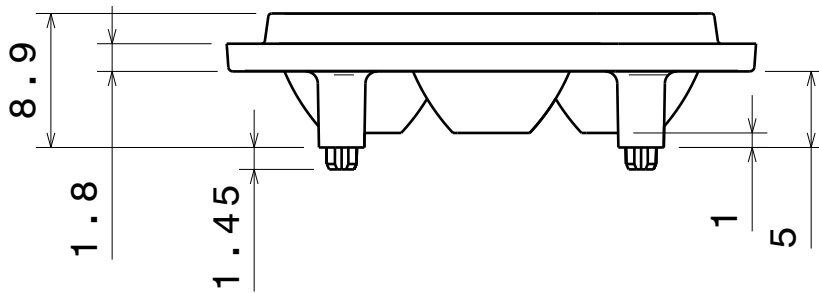

Front view

Material: PMMA

This drawing is our property.
It can't be reproduced
or communicated without
our written agreement.



L
T
F
F

e
e
i
i
N
n

d

DRAWING TITLE

Datasheet GT4-XP series Lens

DRAWN BY

DATE

30.12.2009

CHECKED BY

DATE

23.12.2009

DESIGNED BY

DATE

23.07.2009

SIZE

A4

DRAWING NUMBER

C10921

REV

1

SCALE

2:1

WEIGHT (g)

SHEET

1/1

D

A

4

4

3

3

2

2

1

1

Ledil Oy C10923_GT4-XP-W C10923_GT4-XP-W / LDC (Linear)

Luminaire: Ledil Oy C10923_GT4-XP-W C10923_GT4-XP-W
Lamps: 4 x Cree XP-E (White)

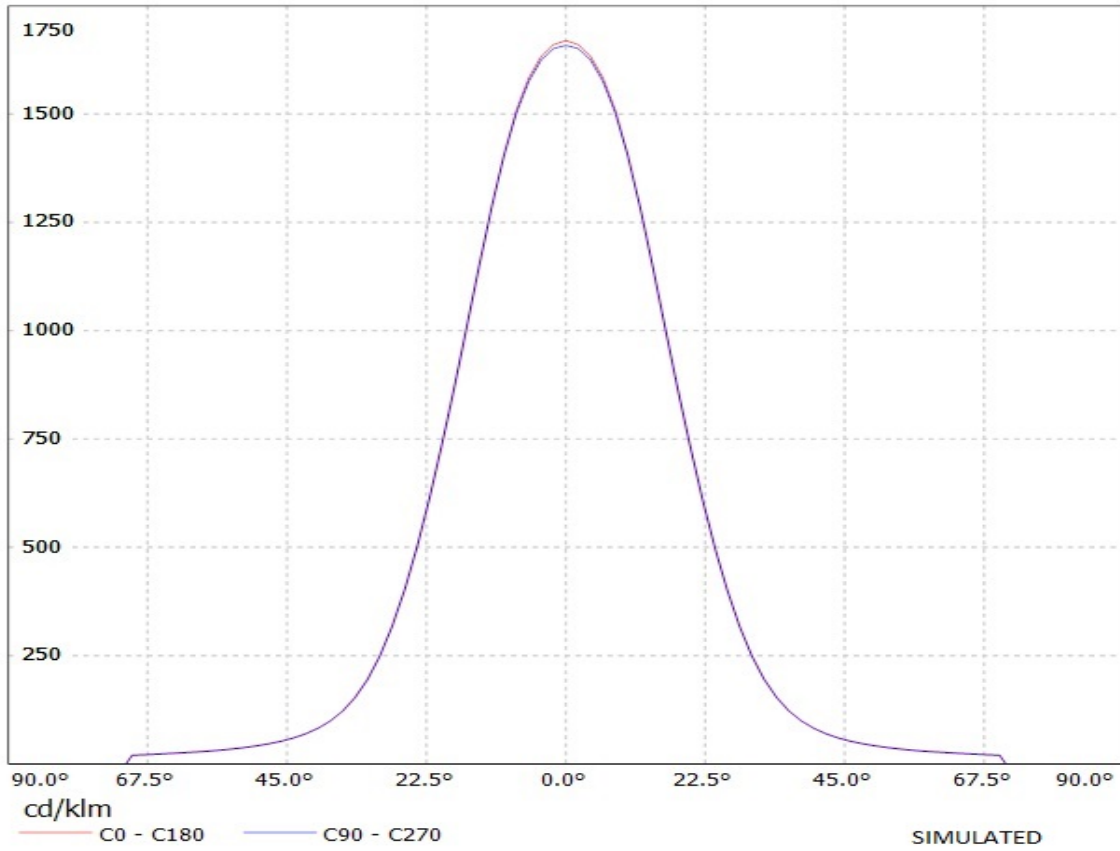

Ledil Oy C10923_GT4-XP-G-W C10923_GT4-XP-G-W / LDC (Linear)

Luminaire: Ledil Oy C10923_GT4-XP-G-W C10923_GT4-XP-G-W
Lamps: 4 x Cree XP-G (White)

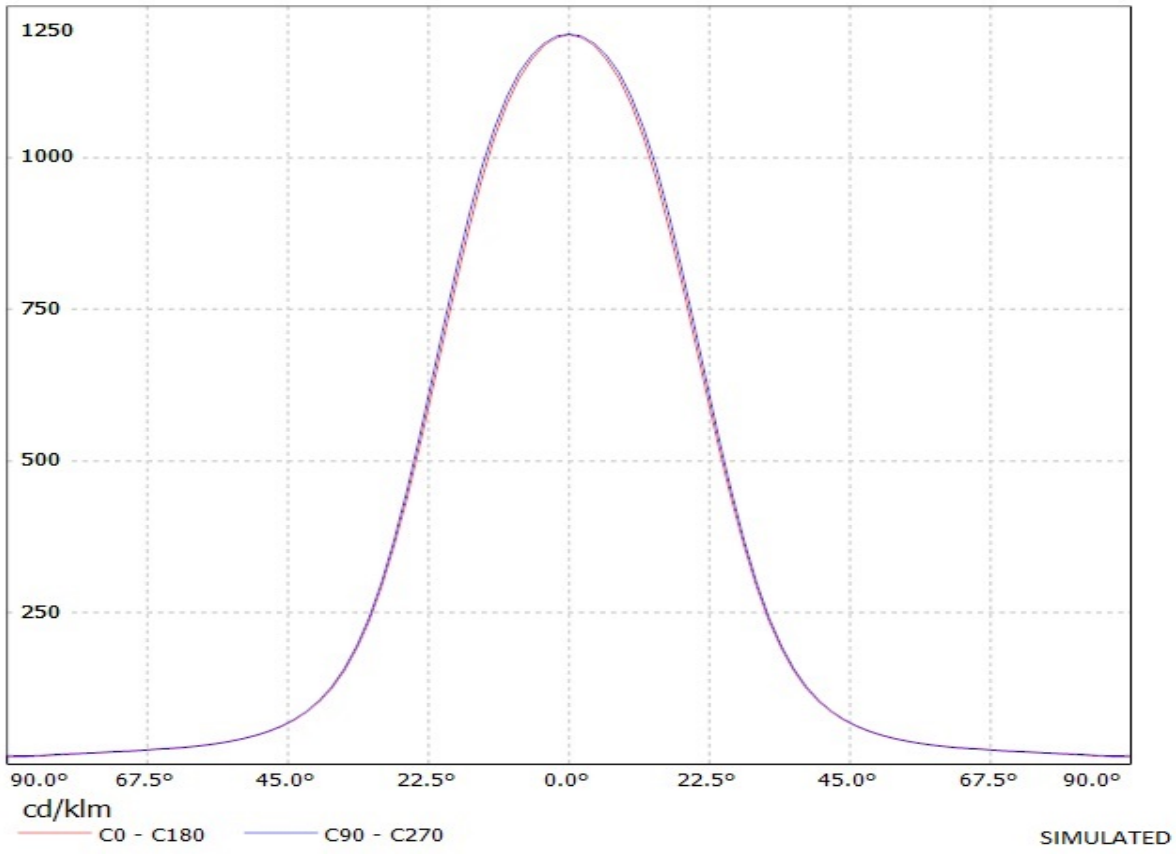

Ledil Oy C10923_GT4-XP-W C10923_GT4-XP-W / LDC (Polar)

Luminaire: Ledil Oy C10923_GT4-XP-W C10923_GT4-XP-W

Lamps: 4 x Cree XP-E (White)

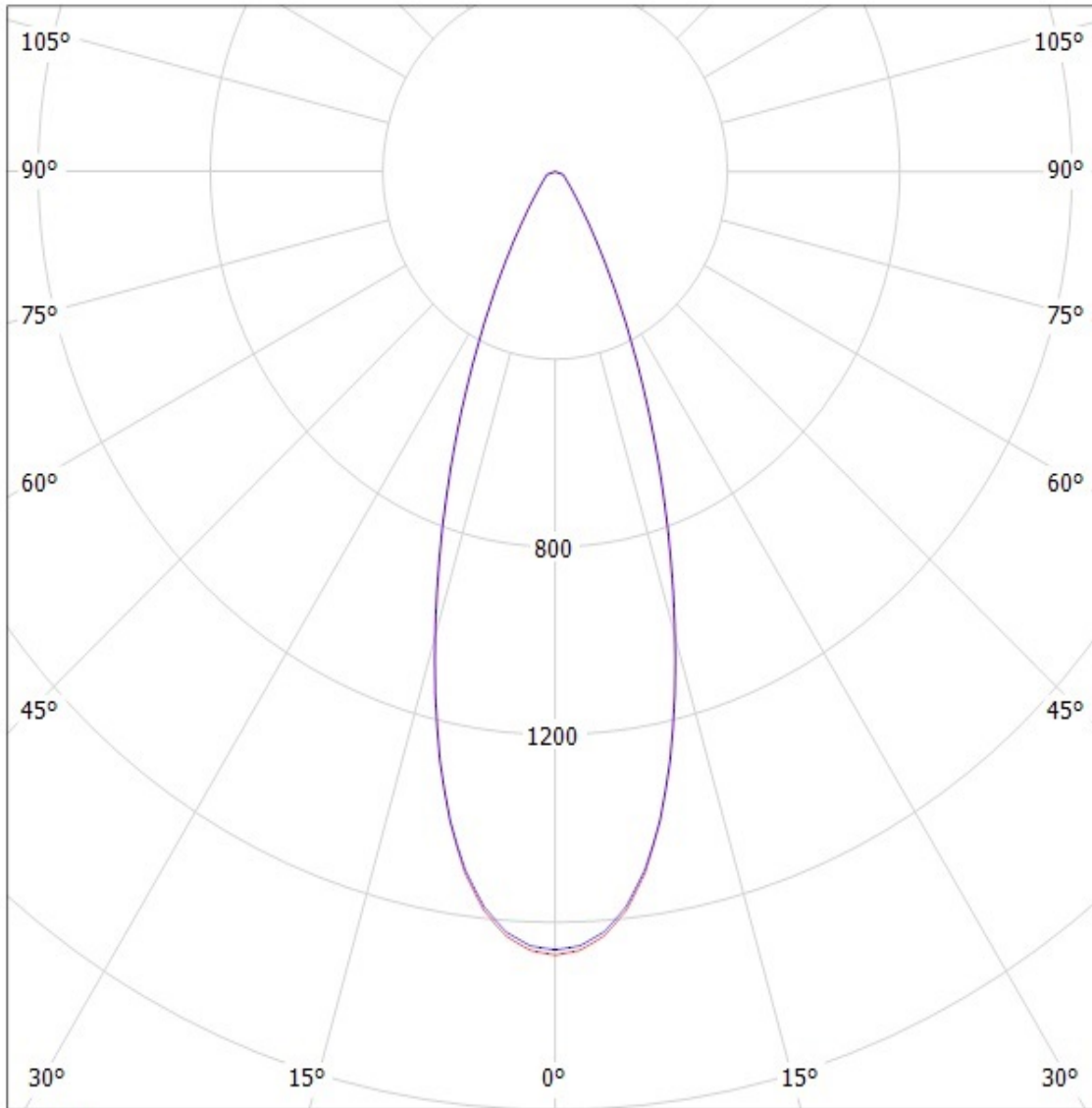

cd/klm

— C0 - C180 — C90 - C270

SIMULATED

Ledil Oy C10923_GT4-XP-G-W C10923_GT4-XP-G-W / LDC (Polar)

Luminaire: Ledil Oy C10923_GT4-XP-G-W C10923_GT4-XP-G-W

Lamps: 4 x Cree XP-G (White)

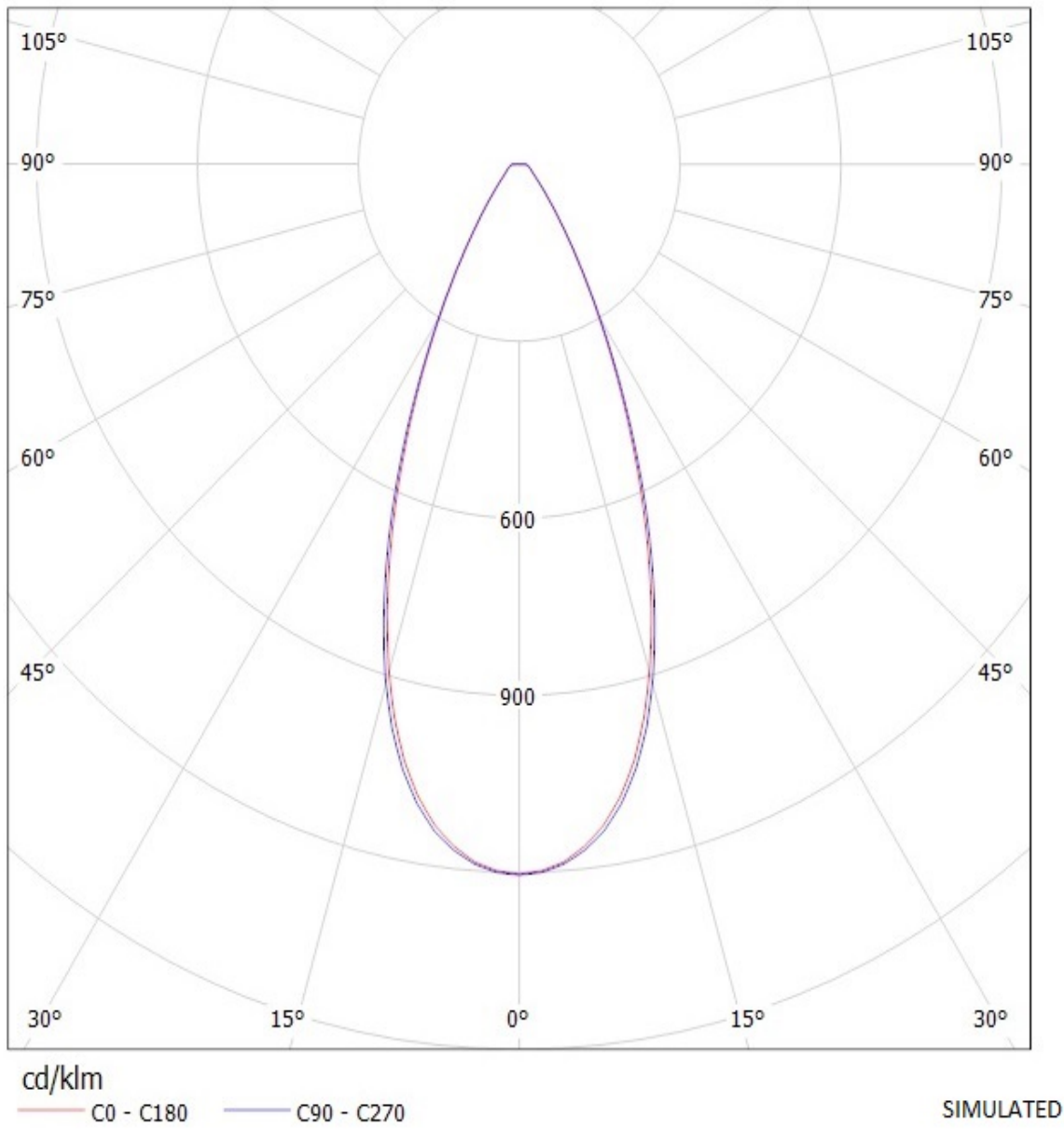

NOTE: The typical divergence will be changed by different color, chip size and chip position tolerance. The typical total divergence is the full angle measured where the luminous intensity is half of the peak value.