



## SOT-23 Plastic-Encapsulate Diodes

### BAS40/-04/-05/-06 SCHOTTKY BARRIER DIODE

#### FEATURES

- Low Forward Voltage
- Fast Switching

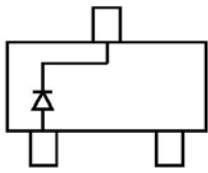
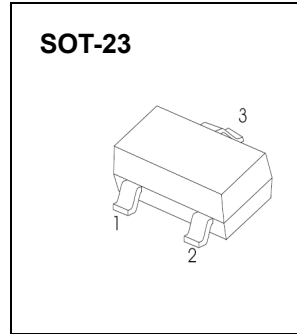

BAS40 MARKING: 43•  
MARKING:

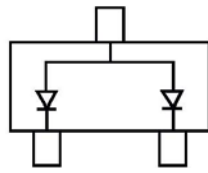

BAS40-06 MARKING: 46

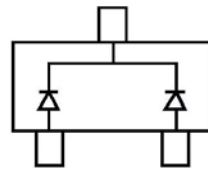

BAS40-05 MARKING: 45

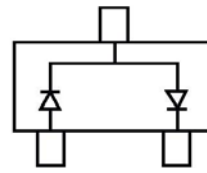

BAS40-04 MARKING: 44

BAS40	BAS40-06	BAS40-05	BAS40-04

Solid dot = Green molding compound device, if none, the normal device.

#### Maximum Ratings @Ta=25°C

Parameter	Symbol	Limit	Unit
Peak repetitive peak reverse voltage	$V_{RRM}$	40	V
Working peak reverse voltage	$V_{RWM}$		
DC blocking voltage	$V_R$		
Forward continuous current	$I_{FM}$	200	mA
Power dissipation	$P_D$	200	mW
Thermal resistance junction to ambient	$R_{\theta JA}$	500	°C/W
Junction temperature	$T_J$	125	°C
Storage temperature range	$T_{STG}$	-55~+150	°C

#### ELECTRICAL CHARACTERISTICS (Ta=25°C unless otherwise specified)

Parameter	Symbol	Test conditions	Min	Max	Unit
Reverse breakdown voltage	$V_{(BR)}$	$I_R=10\mu A$	40		V
Reverse voltage leakage current	$I_R$	$V_R=30V$		200	nA
Forward voltage	$V_F$	$I_F=1mA$ $I_F=40mA$		380 1000	mV
Diode capacitance	$C_D$	$V_R=0, f=1MHz$		5	pF
Reverse recovery time	$t_{rr}$	$I_{rr}=1mA, I_R=I_F=10mA$ $R_L=100\Omega$		5	ns

# Typical Characteristics

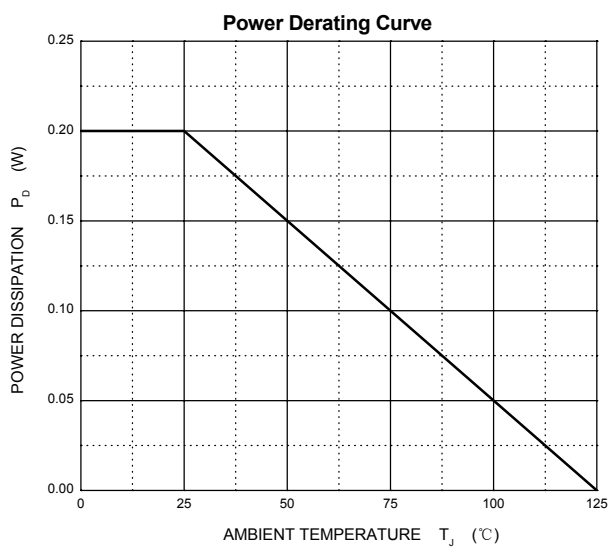
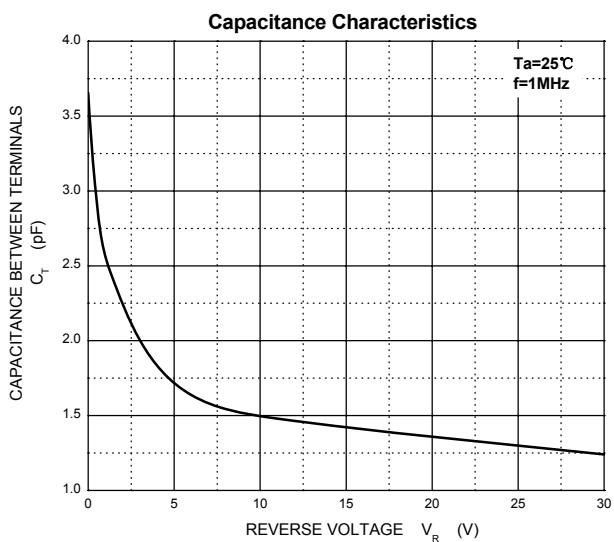
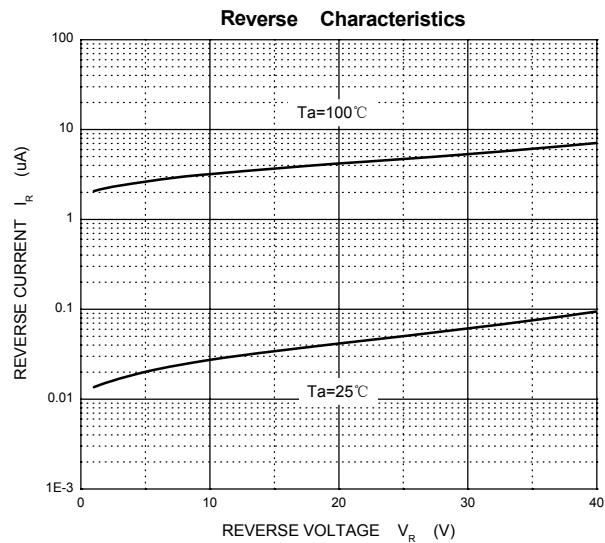
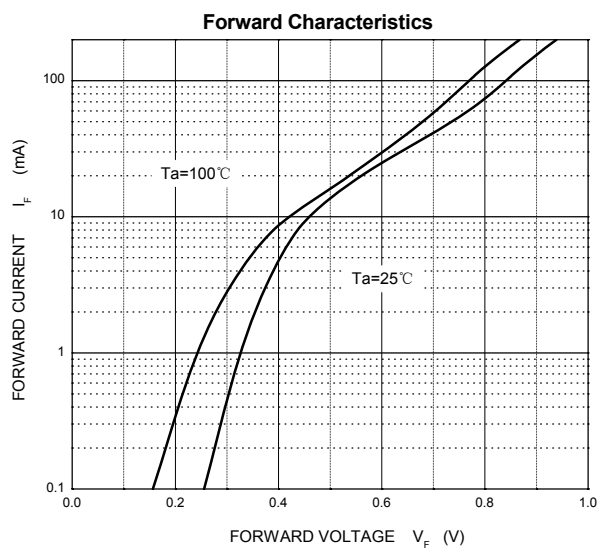

## SOT-23 Package Outline Dimensions



Symbol	Dimensions In Millimeters		Dimensions In Inches	
	Min	Max	Min	Max
A	0.900	1.150	0.035	0.045
A1	0.000	0.100	0.000	0.004
A2	0.900	1.050	0.035	0.041
b	0.300	0.500	0.012	0.020
c	0.080	0.150	0.003	0.006
D	2.800	3.000	0.110	0.118
E	1.200	1.400	0.047	0.055
E1	2.250	2.550	0.089	0.100
e	0.950 TYP		0.037 TYP	
e1	1.800	2.000	0.071	0.079
L	0.550 REF		0.022 REF	
L1	0.300	0.500	0.012	0.020
$\theta$	0°	8°	0°	8°

## SOT-23 Suggested Pad Layout



**Note:**

1. Controlling dimension: in millimeters.
2. General tolerance:  $\pm 0.05\text{mm}$ .
3. The pad layout is for reference purposes only.

### NOTICE

JCET reserve the right to make modifications, enhancements, improvements, corrections or other changes without further notice to any product herein. JCET does not assume any liability arising out of the application or use of any product described herein.

# SOT-23 Tape and Reel

## SOT-23 Embossed Carrier Tape



### Packaging Description:

SOT-23 parts are shipped in tape. The carrier tape is made from a dissipative (carbon filled) polycarbonate resin. The cover tape is a multilayer film (Heat Activated Adhesive in nature) primarily composed of polyester film, adhesive layer, sealant, and anti-static sprayed agent. These reeled parts in standard option are shipped with 3,000 units per 7" or 17.8cm diameter reel. The reels are clear in color and is made of polystyrene plastic (anti-static coated).

Dimensions are in millimeter

Pkg type	A	B	C	d	E	F	P0	P	P1	W
SOT-23	3.15	2.77	1.22	Ø1.50	1.75	3.50	4.00	4.00	2.00	8.00

## SOT-23 Tape Leader and Trailer

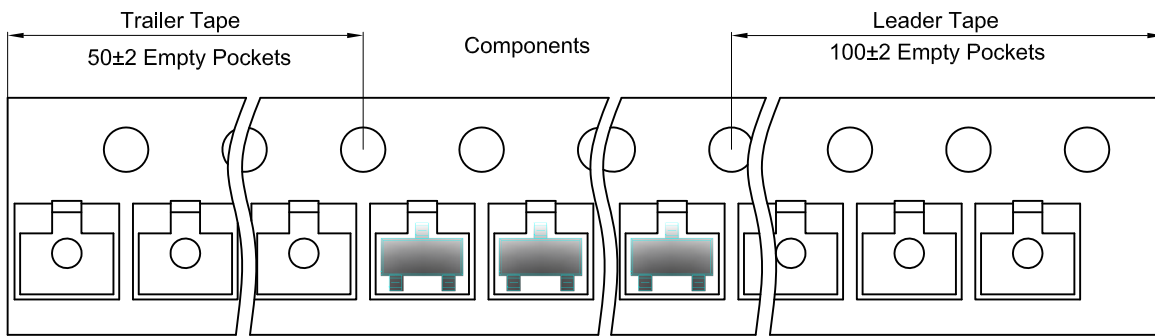

## SOT-23 Reel

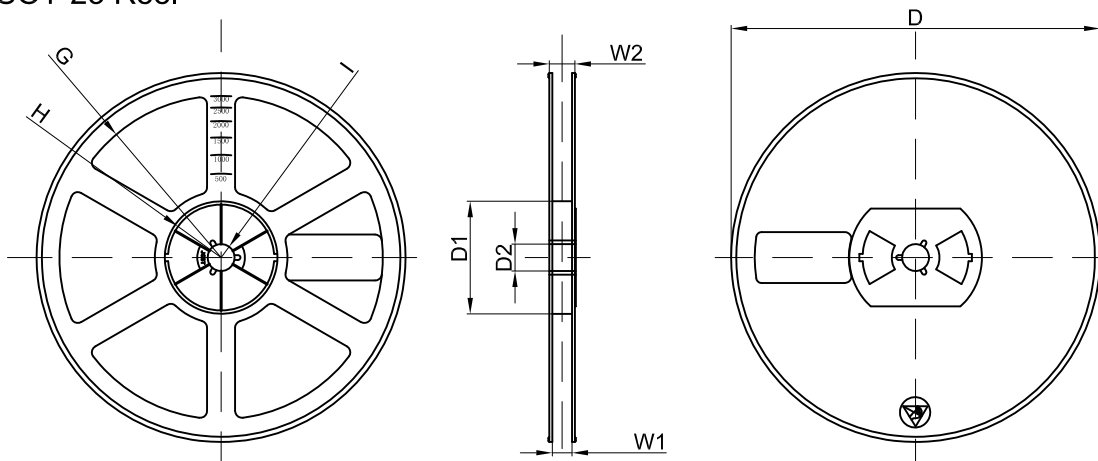

Dimensions are in millimeter

Reel Option	D	D1	D2	G	H	I	W1	W2
7"Dia	Ø178.00	54.40	13.00	R78.00	R25.60	R6.50	9.50	12.30

REEL	Reel Size	Box	Box Size(mm)	Carton	Carton Size(mm)	G.W.(kg)
3000 pcs	7 inch	45,000 pcs	203×203×195	180,000 pcs	438×438×220	