

Inverter Grade Thyristors (Stud Version), 85 A



FEATURES

- Center amplifying gate
- High surge current capability
- Low thermal impedance
- High speed performance
- Compression bonding
- Designed and qualified for industrial level
- Material categorization: For definitions of compliance please see www.vishay.com/doc?99912

RoHS
COMPLIANT

PRODUCT SUMMARY

| | |
|--------------------|------------------|
| Package | TO-209AC (TO-94) |
| Diode variation | Single SCR |
| $I_{T(AV)}$ | 85 A |
| V_{DRM}/V_{RRM} | 400 V to 1200 V |
| V_{TM} | 2.15 V |
| I_{TSM} at 50 Hz | 2450 A |
| I_{TSM} at 60 Hz | 2560 A |
| I_{GT} | 200 mA |
| T_C/T_{hs} | 85 °C |

TYPICAL APPLICATIONS

- Inverters
- Choppers
- Induction heating
- All types of force-commutated converters

MAJOR RATINGS AND CHARACTERISTICS

| PARAMETER | TEST CONDITIONS | VALUES | UNITS |
|-------------------|-----------------|-------------|-------------------|
| $I_{T(AV)}$ | | 85 | A |
| | T_C | 85 | °C |
| $I_{T(RMS)}$ | | 135 | A |
| I_{TSM} | 50 Hz | 2450 | A |
| | 60 Hz | 2560 | A |
| I^2t | 50 Hz | 30 | kA ² s |
| | 60 Hz | 27 | |
| V_{DRM}/V_{RRM} | | 400 to 1200 | V |
| t_q | Range | 10 to 20 | µs |
| T_J | | -40 to 125 | °C |

ELECTRICAL SPECIFICATIONS

VOLTAGE RATINGS

| TYPE NUMBER | VOLTAGE CODE | V_{DRM}/V_{RRM} : MAXIMUM REPETITIVE PEAK VOLTAGE V | V_{RSM} : MAXIMUM NON-REPETITIVE PEAK VOLTAGE V | I_{DRM}/I_{RRM} MAX. AT $T_J = T_J$ MAX. mA |
|-------------|--------------|--|--|--|
| VS-ST083S | 04 | 400 | 500 | 30 |
| | 08 | 800 | 900 | |
| | 10 | 1000 | 1100 | |
| | 12 | 1200 | 1300 | |



| CURRENT CARRYING CAPABILITY | | | | | | | |
|----------------------------------|-----------|-----|-----------|-----|-----------|------|-------|
| FREQUENCY | | | | | | | UNITS |
| 50 Hz | 210 | 120 | 330 | 270 | 2540 | 1930 | A |
| 400 Hz | 200 | 120 | 350 | 210 | 1190 | 810 | |
| 1000 Hz | 150 | 80 | 320 | 190 | 630 | 400 | |
| 2500 Hz | 70 | 25 | 220 | 85 | 250 | 100 | |
| Recovery voltage V_r | 50 | 50 | 50 | 50 | 50 | 50 | V |
| Voltage before turn-on V_d | V_{DRM} | | V_{DRM} | | V_{DRM} | | |
| Rise of on-state current dI/dt | 50 | 50 | - | - | - | - | A/µs |
| Case temperature | 60 | 85 | 60 | 85 | 60 | 85 | °C |
| Equivalent values for RC circuit | 22/0.15 | | 22/0.15 | | 22/0.15 | | W/µF |

| ON-STATE CONDUCTION | | | | | |
|--|---------------|---|---------------------------|--------|---------------------|
| PARAMETER | SYMBOL | TEST CONDITIONS | | VALUES | UNITS |
| Maximum average on-state current at case temperature | $I_{T(AV)}$ | 180° conduction, half sine wave | | 85 | A |
| | | | | 85 | °C |
| Maximum RMS on-state current | $I_{T(RMS)}$ | DC at 77 °C case temperature | | 135 | A |
| Maximum peak, one half cycle, non-repetitive surge current | I_{TSM} | t = 10 ms | No voltage reapplied | 2450 | |
| | | t = 8.3 ms | No voltage reapplied | 2560 | |
| | | t = 10 ms | 100 % V_{RRM} reapplied | 2060 | |
| | | t = 8.3 ms | 100 % V_{RRM} reapplied | 2160 | |
| Maximum I^2t for fusing | I^2t | t = 10 ms | No voltage reapplied | 30 | kA ² s |
| | | t = 8.3 ms | No voltage reapplied | 27 | |
| | | t = 10 ms | 100 % V_{RRM} reapplied | 21 | |
| | | t = 8.3 ms | 100 % V_{RRM} reapplied | 19 | |
| Maximum $I^2\sqrt{t}$ for fusing | $I^2\sqrt{t}$ | t = 0.1 ms to 10 ms, no voltage reapplied | | 300 | kA ² /√s |
| Maximum peak on-state voltage | V_{TM} | $I_{TM} = 300$ A, $T_J = T_J$ maximum, $t_p = 10$ ms sine wave pulse | | 2.15 | V |
| Low level value of threshold voltage | $V_{T(TO)1}$ | $(16.7\% \times \pi \times I_{T(AV)} < I < \pi \times I_{T(AV)})$, $T_J = T_J$ maximum | | 1.46 | |
| High level value of threshold voltage | $V_{T(TO)2}$ | $(I > \pi \times I_{T(AV)})$, $T_J = T_J$ maximum | | 1.52 | |
| Low level value of forward slope resistance | r_{t1} | $(16.7\% \times \pi \times I_{T(AV)} < I < \pi \times I_{T(AV)})$, $T_J = T_J$ maximum | | 2.32 | |
| High level value of forward slope resistance | r_{t2} | $(I > \pi \times I_{T(AV)})$, $T_J = T_J$ maximum | | 2.34 | mΩ |
| Maximum holding current | I_H | $T_J = 25$ °C, $I_T > 30$ A | | 600 | mA |
| Typical latching current | I_L | $T_J = 25$ °C, $V_A = 12$ V, $R_a = 6$ Ω, $I_G = 1$ A | | 1000 | |

| SWITCHING | | | | | |
|--|---------|---|--------|------|-------|
| PARAMETER | SYMBOL | TEST CONDITIONS | VALUES | | UNITS |
| | | | MIN. | MAX. | |
| Maximum non-repetitive rate of rise of turned on current | dI/dt | $T_J = T_J$ max., $V_{DRM} = \text{Rated } V_{DRM}$, $I_{TM} = 2 \times dI/dt$ | 1000 | | A/µs |
| Typical delay time | t_d | $T_J = 25$ °C, $V_{DM} = \text{Rated } V_{DM}$, $I_{TM} = 50$ A DC, $t_p = 1$ µs Resistive load, gate pulse: 10 V, 5 Ω source | 0.80 | | µs |
| Maximum turn-off time | t_q | $T_J = T_J$ maximum, $I_{TM} = 100$ A, commutating $dI/dt = 10$ A/µs $V_R = 50$ V, $t_p = 200$ µs, $dV/dt = 200$ V/µs | 10 | 20 | |



| BLOCKING | | | | |
|--|--------------------------|---|--------|------------|
| PARAMETER | SYMBOL | TEST CONDITIONS | VALUES | UNITS |
| Maximum critical rate of rise of off-state voltage | dV/dt | $T_J = T_J$ maximum, linear to 80 % V_{DRM} , higher value available on request | 500 | V/ μ s |
| Maximum peak reverse and off-state leakage current | I_{RRM} , I_{DRM} | $T_J = T_J$ maximum, rated V_{DRM}/V_{RRM} applied | 30 | mA |

| TRIGGERING | | | | |
|---|-------------|--|--------|-------|
| PARAMETER | SYMBOL | TEST CONDITIONS | VALUES | UNITS |
| Maximum peak gate power | P_{GM} | $T_J = T_J$ maximum, f = 50 Hz, d% = 50 | 40 | W |
| Maximum average gate power | $P_{G(AV)}$ | | 5 | |
| Maximum peak positive gate current | I_{GM} | $T_J = T_J$ maximum, $t_p \leq 5$ ms | 5 | A |
| Maximum peak positive gate voltage | + V_{GM} | | 20 | V |
| Maximum peak negative gate voltage | - V_{GM} | | 5 | |
| Maximum DC gate current required to trigger | I_{GT} | $T_J = 25$ °C, $V_A = 12$ V, $R_a = 6$ Ω | 200 | mA |
| Maximum DC gate voltage required to trigger | V_{GT} | | 3 | V |
| Maximum DC gate current not to trigger | I_{GD} | $T_J = T_J$ maximum, rated V_{DRM}/V_{RRM} applied | 20 | mA |
| Maximum DC gate voltage not to trigger | V_{GD} | | 0.25 | V |

| THERMAL AND MECHANICAL SPECIFICATIONS | | | | |
|--|------------|---|------------------|---------------------|
| PARAMETER | SYMBOL | TEST CONDITIONS | VALUES | UNITS |
| Maximum junction operating temperature range | T_J | | -40 to 125 | °C |
| Maximum storage temperature range | T_{Stg} | | -40 to 150 | |
| Maximum thermal resistance, junction to case | R_{thJC} | DC operation | 0.195 | K/W |
| Maximum thermal resistance, case to heatsink | R_{thCS} | Mounting surface, smooth, flat and greased | 0.08 | |
| Mounting torque, ± 10 % | | Non-lubricated threads | 15.5 (137) | N · m (lbf · in) |
| | | Lubricated threads | 14 (120) | |
| Approximate weight | | | 130 | g |
| Case style | | See dimensions - link at the end of datasheet | TO-209AC (TO-94) | |

| ΔR_{thJC} CONDUCTION | | | | |
|--|-----------------------|------------------------|---------------------|-------|
| CONDUCTION ANGLE | SINUSOIDAL CONDUCTION | RECTANGULAR CONDUCTION | TEST CONDITIONS | UNITS |
| 180° | 0.034 | 0.025 | $T_J = T_J$ maximum | K/W |
| 120° | 0.041 | 0.042 | | |
| 90° | 0.052 | 0.056 | | |
| 60° | 0.076 | 0.079 | | |
| 30° | 0.126 | 0.127 | | |

Note

- The table above shows the increment of thermal resistance R_{thJC} when devices operate at different conduction angles than DC

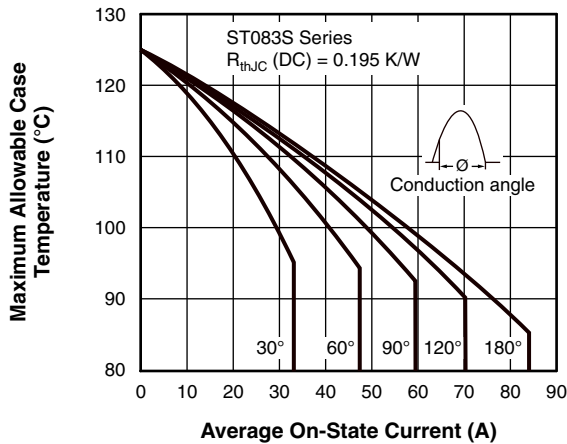

Fig. 1 - Current Ratings Characteristics

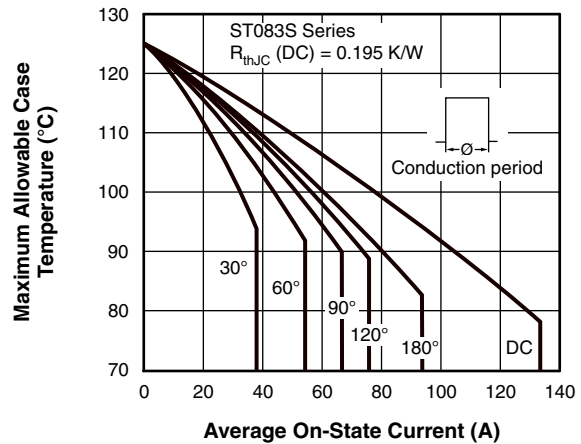

Fig. 2 - Current Ratings Characteristics

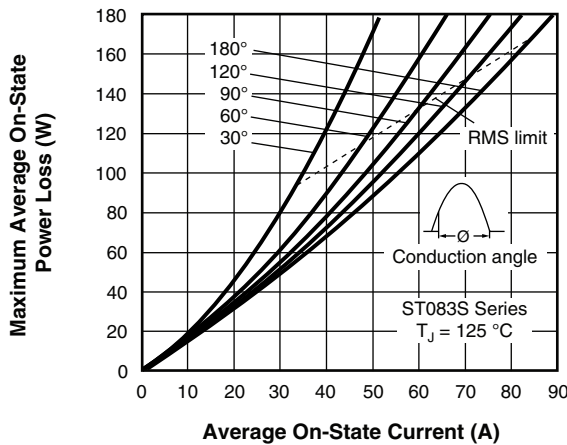

Fig. 3 - On-State Power Loss Characteristics

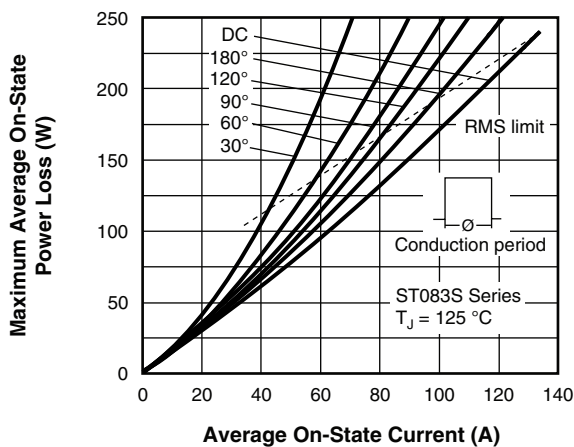
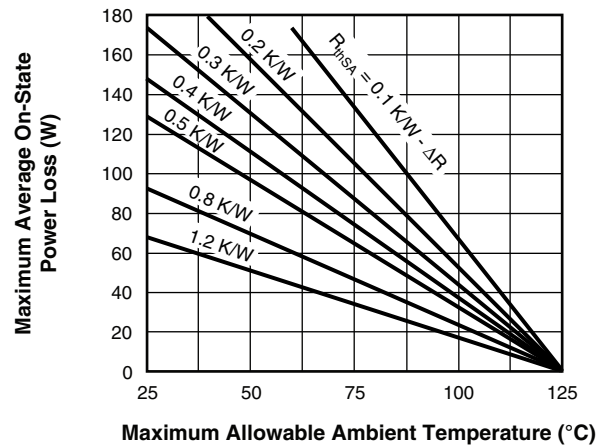
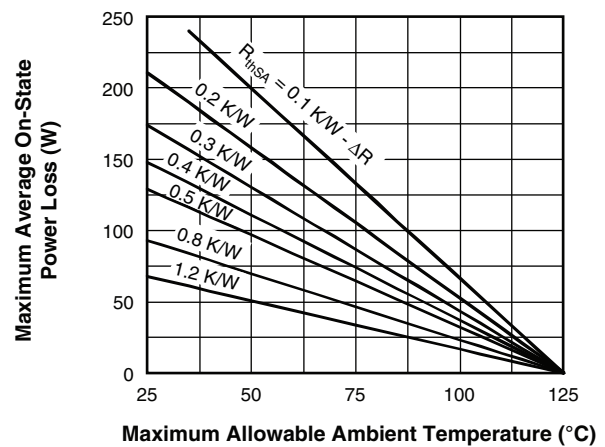

Fig. 4 - On-State Power Loss Characteristics



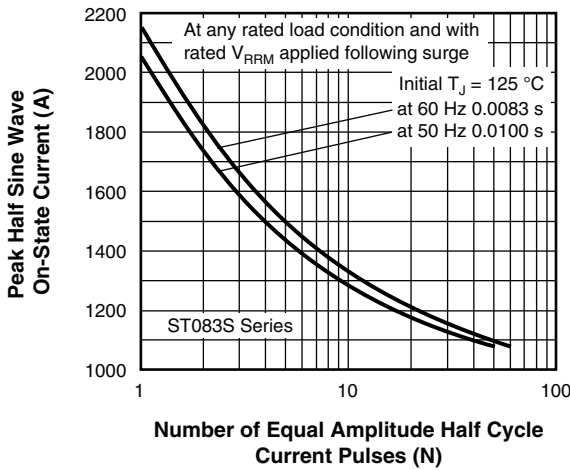

Fig. 5 - Maximum Non-Repetitive Surge Current

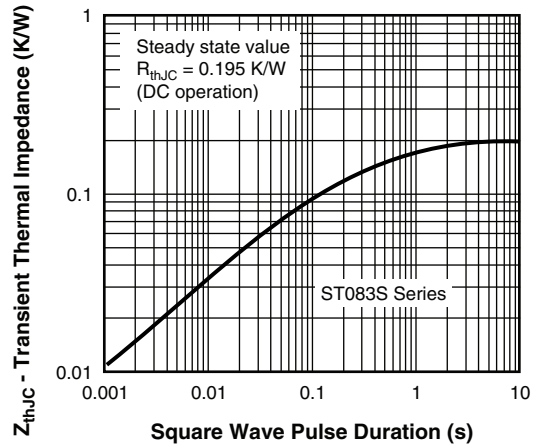

Fig. 8 - Thermal Impedance Z_{thJC} Characteristic

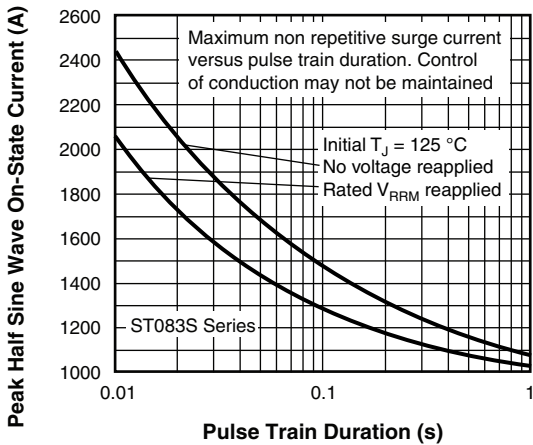

Fig. 6 - Maximum Non-Repetitive Surge Current

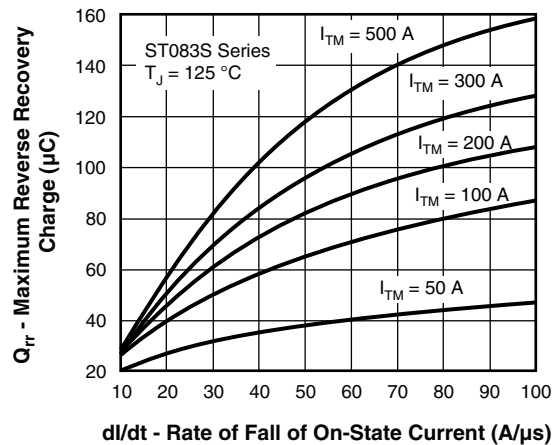

Fig. 9 - Reverse Recovered Charge Characteristics

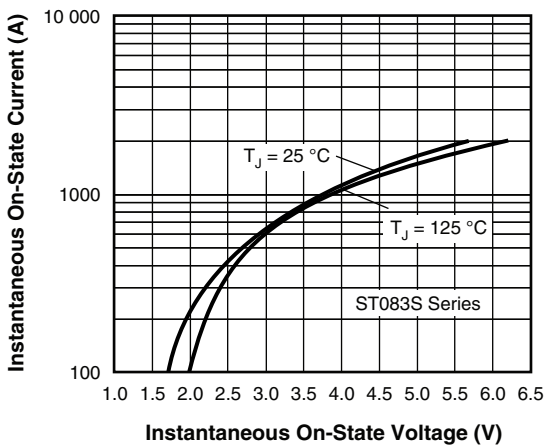

Fig. 7 - On-State Voltage Drop Characteristics

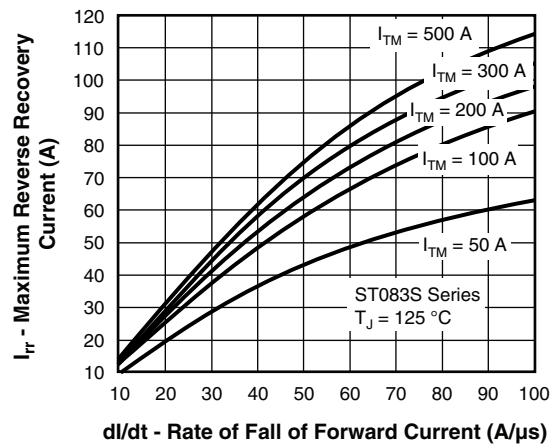

Fig. 10 - Reverse Recovery Current Characteristics

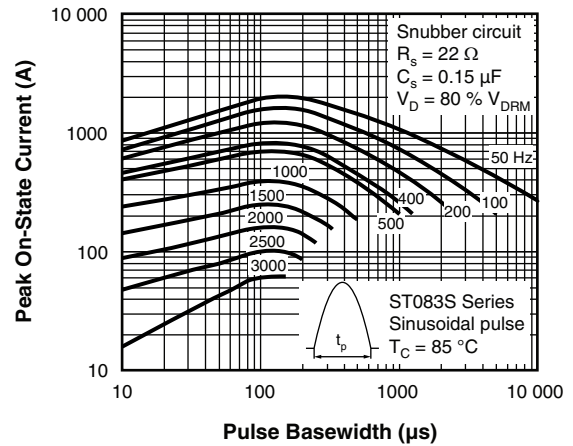
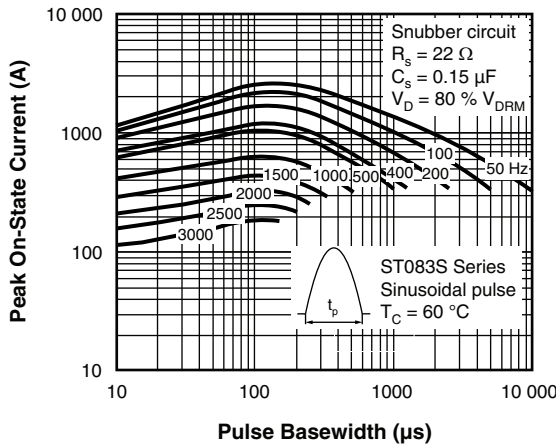

Fig. 11 - Frequency Characteristics

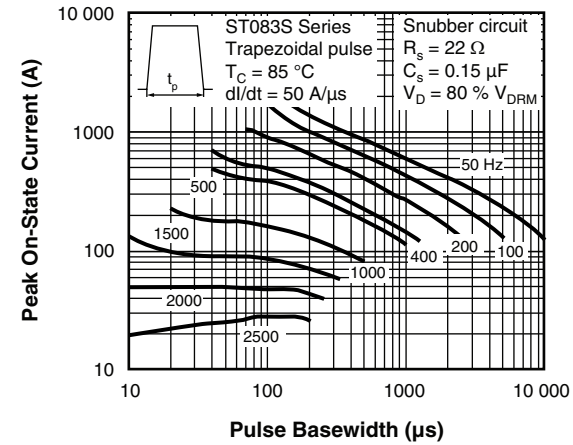
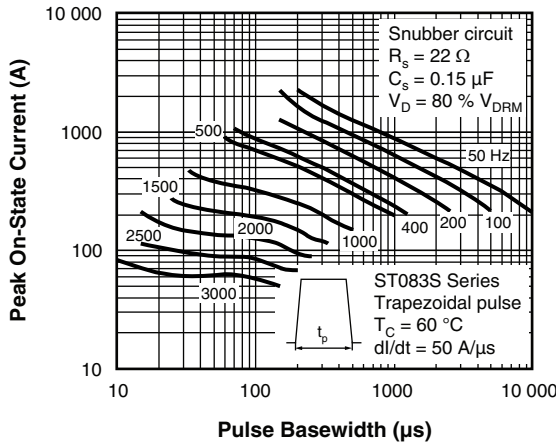

Fig. 12 - Frequency Characteristics

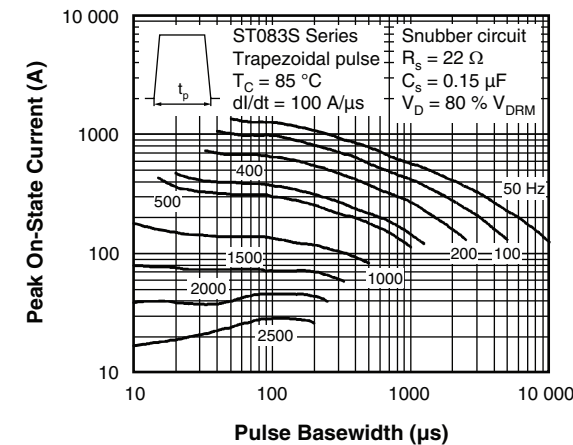
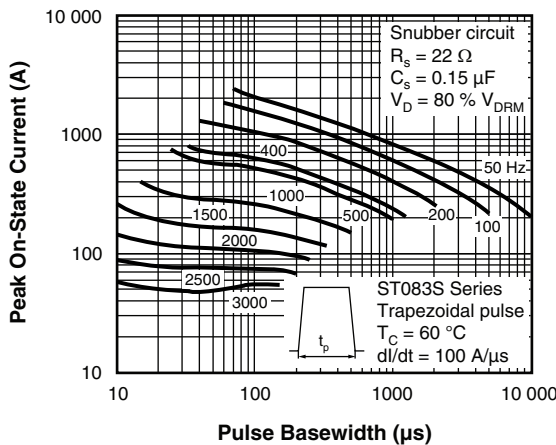

Fig. 13 - Frequency Characteristics

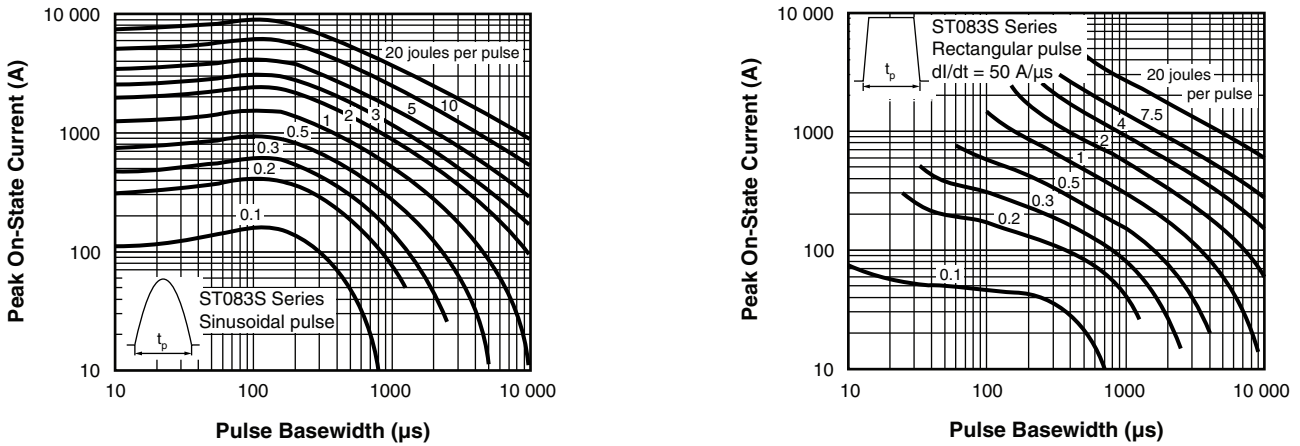

Fig. 14 - Maximum On-State Energy Power Loss Characteristics

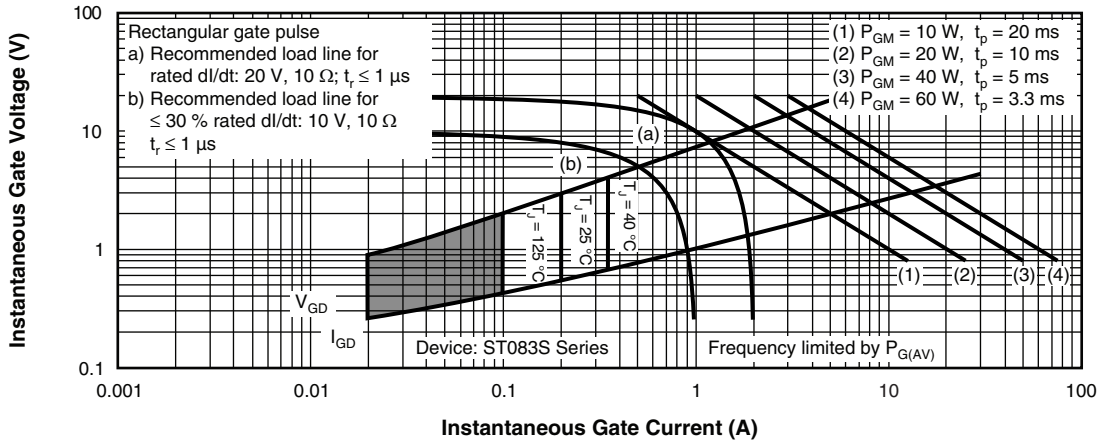
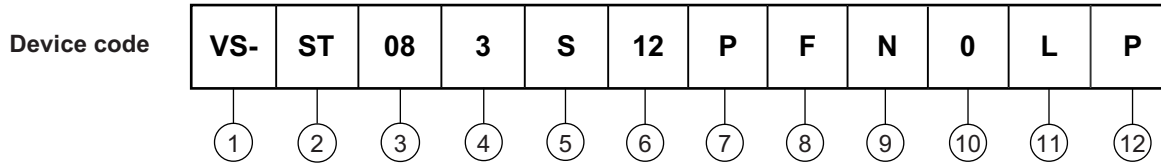

Fig. 15 - Gate Characteristics



ORDERING INFORMATION TABLE



- 1** - Vishay Semiconductors product
- 2** - Thyristor
- 3** - Essential part number
- 4** - 3 = Fast turn-off
- 5** - S = Compression bonding stud
- 6** - Voltage code x 100 = V_{RRM} (see Voltage Ratings table)
- 7** -
 - P = Stud base 1/2"-20UNF-2A threads
 - M = Metric M12, contact factory for availability
- 8** - Reapplied dV/dt code (for t_q test condition)
- 9** - t_q code
- 10** -
 - 0 = Eyelet terminals (gate and aux. cathode leads)
 - 1 = Fast-on terminals (gate and aux. cathode leads)
 - 2 = Flag terminals (gate and aux. cathode leads)
- 11** - Critical dV/dt:
 - None = 500 V/ μ s (standard value)
 - L = 1000 V/ μ s (special selection)
- 12** - None = Standard production; P = Lead (Pb)-free

| dV/dt - t_q combinations available | | |
|---|--------------------|-----|
| | dV/dt (V/ μ s) | 200 |
| t_q (μ s) up to 800V | 10 | FN |
| | 20 | FK |
| t_q (μ s) only for 1000/1200 V | 20 | FK |

| LINKS TO RELATED DOCUMENTS | |
|----------------------------|--|
| Dimensions | www.vishay.com/doc?95003 |

TO-209AC (TO-94) for ST083S and ST103S Series

DIMENSIONS in millimeters (inches)

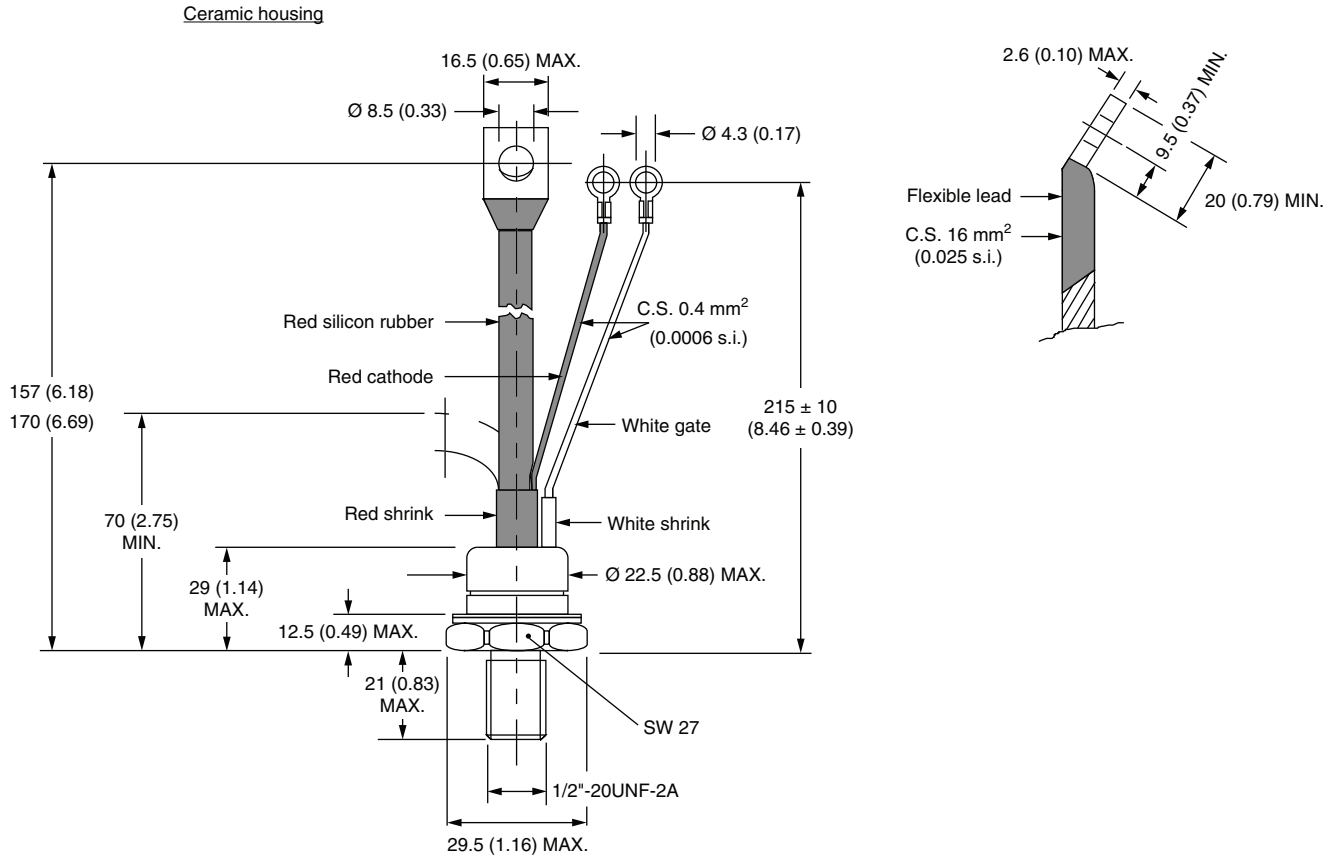



Disclaimer

ALL PRODUCT, PRODUCT SPECIFICATIONS AND DATA ARE SUBJECT TO CHANGE WITHOUT NOTICE TO IMPROVE RELIABILITY, FUNCTION OR DESIGN OR OTHERWISE.

Vishay Intertechnology, Inc., its affiliates, agents, and employees, and all persons acting on its or their behalf (collectively, "Vishay"), disclaim any and all liability for any errors, inaccuracies or incompleteness contained in any datasheet or in any other disclosure relating to any product.

Vishay makes no warranty, representation or guarantee regarding the suitability of the products for any particular purpose or the continuing production of any product. To the maximum extent permitted by applicable law, Vishay disclaims (i) any and all liability arising out of the application or use of any product, (ii) any and all liability, including without limitation special, consequential or incidental damages, and (iii) any and all implied warranties, including warranties of fitness for particular purpose, non-infringement and merchantability.

Statements regarding the suitability of products for certain types of applications are based on Vishay's knowledge of typical requirements that are often placed on Vishay products in generic applications. Such statements are not binding statements about the suitability of products for a particular application. It is the customer's responsibility to validate that a particular product with the properties described in the product specification is suitable for use in a particular application. Parameters provided in datasheets and/or specifications may vary in different applications and performance may vary over time. All operating parameters, including typical parameters, must be validated for each customer application by the customer's technical experts. Product specifications do not expand or otherwise modify Vishay's terms and conditions of purchase, including but not limited to the warranty expressed therein.

Except as expressly indicated in writing, Vishay products are not designed for use in medical, life-saving, or life-sustaining applications or for any other application in which the failure of the Vishay product could result in personal injury or death. Customers using or selling Vishay products not expressly indicated for use in such applications do so at their own risk. Please contact authorized Vishay personnel to obtain written terms and conditions regarding products designed for such applications.

No license, express or implied, by estoppel or otherwise, to any intellectual property rights is granted by this document or by any conduct of Vishay. Product names and markings noted herein may be trademarks of their respective owners.

Material Category Policy

Vishay Intertechnology, Inc. hereby certifies that all its products that are identified as RoHS-Compliant fulfill the definitions and restrictions defined under Directive 2011/65/EU of The European Parliament and of the Council of June 8, 2011 on the restriction of the use of certain hazardous substances in electrical and electronic equipment (EEE) - recast, unless otherwise specified as non-compliant.

Please note that some Vishay documentation may still make reference to RoHS Directive 2002/95/EC. We confirm that all the products identified as being compliant to Directive 2002/95/EC conform to Directive 2011/65/EU.

Vishay Intertechnology, Inc. hereby certifies that all its products that are identified as Halogen-Free follow Halogen-Free requirements as per JEDEC JS709A standards. Please note that some Vishay documentation may still make reference to the IEC 61249-2-21 definition. We confirm that all the products identified as being compliant to IEC 61249-2-21 conform to JEDEC JS709A standards.

Mouser Electronics

Authorized Distributor

Click to View Pricing, Inventory, Delivery & Lifecycle Information:

[Vishay:](#)

[ST083S04PFK1](#) [ST083S04PFM1](#) [ST083S04PFM1P](#) [ST083S04PFN1](#) [ST083S08PFM0P](#) [ST083S08PFM1](#)
[ST083S08PFM1P](#) [ST083S08PFN2](#) [ST083S10PFK1](#) [ST083S10PFK2](#) [ST083S12PFK0L](#) [ST083S12PFK0LP](#)
[ST083S12PFK1](#) [VS-ST083S10PFK1P](#) [VS-ST083S12PFK0P](#) [VS-ST083S08PFN1P](#) [VS-ST083S08PFN2P](#) [VS-](#)
[ST083S12PFK1P](#) [ST083S08PFM0](#) [ST083S08PFN0](#) [ST083S08PFN1](#) [ST083S10PFK0](#) [ST083S10PFP0](#)
[ST083S12PFK0](#) [VS-ST083S10PFK2P](#) [VS-ST083S08PFN0P](#) [VS-ST083S04PFN1P](#) [VS-ST083S10PFK0P](#)