

CZRA4728B-HF Thru. CZRA1330B-HF

Zener Voltage: 3.3 to 330 Volts

DC Power: 1 Watts

RoHS Device

Halogen Free

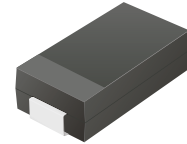

Features

- Glass passivated chip.
- Low leakage.
- For use in stabilizing and clipping with high power rating.
- Built-in strain relief.
- Low inductance.
- High peak reverse power dissipation.

Mechanical data

- Case: JEDEC DO-214AC, molded plastic.
- Epoxy: UL 94V-0 rate flame retardant.
- Lead: Solderable per MIL-STD-750, method 2026.
- Polarity: Color band denotes cathode end.
- Mounting position: Any.
- Approx. weight: 0.069 grams

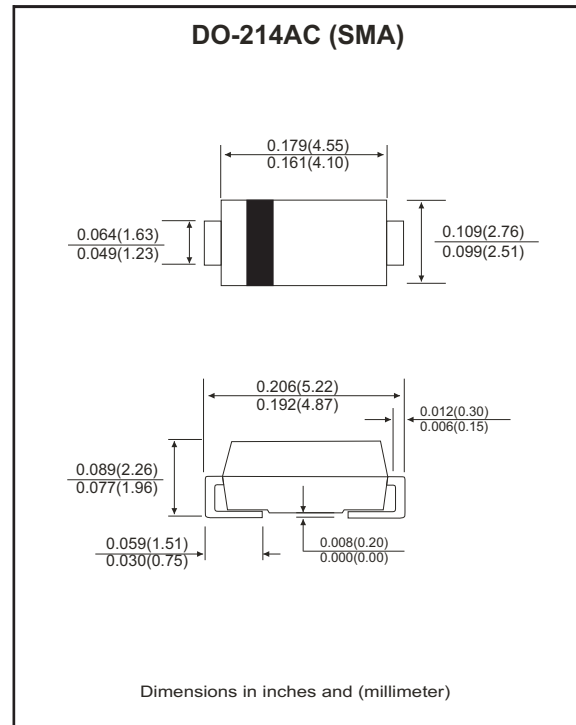

Maximum Ratings and Electrical Characteristics

Ratings at 25°C ambient temperature unless otherwise specified.
 Single phase, half wave, 60Hz, resistive or inductive load.
 For capacitive load, derate current by 20%.

Characteristics	Symbol	Value	Units
DC power dissipation at $T_L=50^\circ\text{C}$ (Note 1)	P_D	1	W
Max. forward voltage at $I_F=200\text{ mA}$	V_F	1.2	V
Maximum thermal resistance junction to ambient air (Note 2)	$R_{\theta JA}$	170	K/W
Junction temperature range	T_J	-55 to +175	$^\circ\text{C}$
Storage temperature range	T_{STG}	-55 to +175	$^\circ\text{C}$

Notes:

1. T_L = Lead temperature at 3/8" (9.5mm) from body.
2. Valid provided that leads are kept at ambient temperature at a distance of 10mm from case.

Company reserves the right to improve product design, functions and reliability without notice.

REV: A

RATING AND CHARACTERISTIC CURVES (CZRA4728B-HF Thru. CZRA1330B-HF)

Fig.1 - Power Temperature Derating Curve

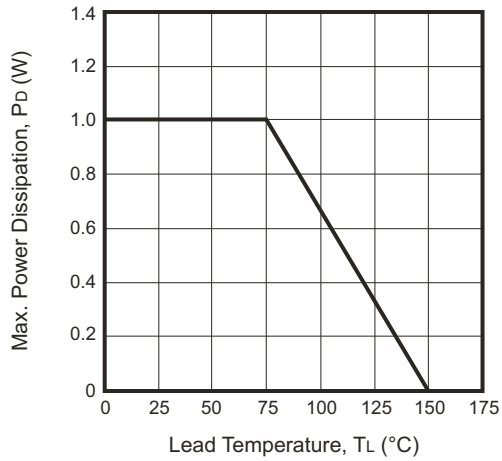

Fig.2 - Temperature Coefficients v.s. Zener Voltage

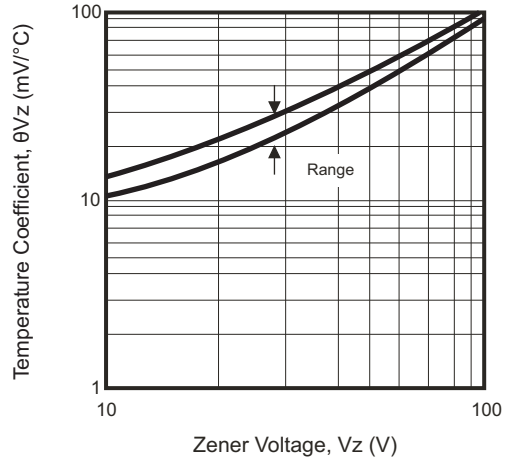

Fig.3 - Typical Thermal Resistance v.s. Lead Length

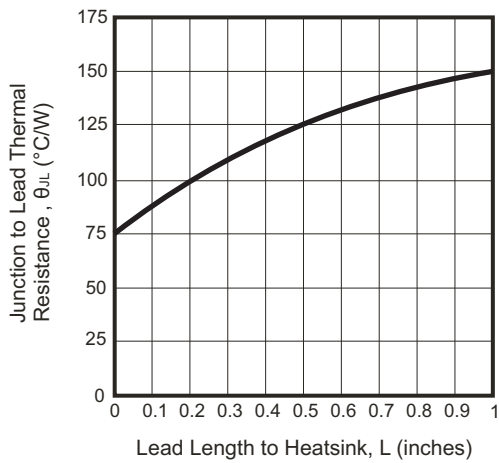
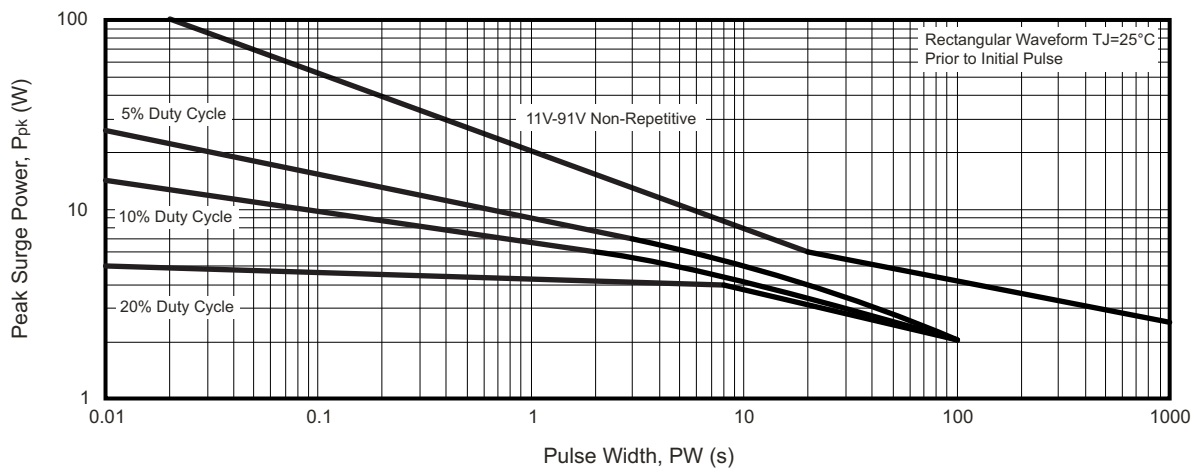

Fig.4 - Maximum Surge Power



Company reserves the right to improve product design, functions and reliability without notice.

Electrical Characteristics (CZRA4728B-HF Thru. CZRA1330B-HF)

Part No	Nominal Zener Voltage		Maximum Zener Impedance			Maximum Reverse Leakage Current		Maximum DC Zener Current	Maximum Surge Current	Marking Code
	V _{Z@I_{ZT}} (V)	I _{ZT} (mA)	Z _{ZT@I_{ZT}} (Ω)	Z _{Zk@I_{Zk}} (Ω)	I _{Zk} (mA)	I _R (μA)	V _R (V)	I _{ZM} (mA)	I _{RM} (mApk)	
CZRA4728B-HF	3.3	76.0	10.0	400	1.00	100.0	1.0	274.0	1370	28A
CZRA4729B-HF	3.6	69.0	10.0	400	1.00	100.0	1.0	251.0	1255	29A
CZRA4730B-HF	3.9	64.0	9.0	400	1.00	50.0	1.0	232.0	1160	30A
CZRA4731B-HF	4.3	58.0	9.0	400	1.00	10.0	1.0	210.0	1050	31A
CZRA4732B-HF	4.7	53.0	8.0	500	1.00	10.0	1.0	192.0	960	32A
CZRA4733B-HF	5.1	49.0	7.0	550	1.00	10.0	1.0	177.0	885	33A
CZRA4734B-HF	5.6	45.0	5.0	600	1.00	10.0	2.0	161.0	805	34A
CZRA4735B-HF	6.2	41.0	2.0	700	1.00	10.0	3.0	146.0	730	35A
CZRA4736B-HF	6.8	37.0	3.5	700	1.00	5.0	4.0	133.0	660	36A
CZRA4737B-HF	7.5	34.0	4.0	700	0.50	5.0	5.0	121.0	605	37A
CZRA4738B-HF	8.2	31.0	4.5	700	0.50	5.0	6.0	110.0	550	38A
CZRA4739B-HF	9.1	28.0	5.0	700	0.50	0.5	7.0	100.0	500	39A
CZRA4740B-HF	10.0	25.0	7.0	700	0.25	0.5	7.6	91.0	454	40A
CZRA4741B-HF	11.0	23.0	8.0	700	0.25	0.1	8.4	83.0	414	41A
CZRA4742B-HF	12.0	21.0	9.0	700	0.25	0.1	9.1	76.0	380	42A
CZRA4743B-HF	13.0	19.0	10.0	700	0.25	0.1	9.9	69.0	344	43A
CZRA4744B-HF	15.0	17.0	14.0	700	0.25	0.1	11.4	61.0	305	44A
CZRA4745B-HF	16.0	15.5	16.0	700	0.25	0.1	12.2	57.0	285	45A
CZRA4746B-HF	18.0	14.0	20.0	750	0.25	0.1	13.7	50.0	250	46A
CZRA4747B-HF	20.0	12.5	22.0	750	0.25	0.1	15.2	45.0	225	47A
CZRA4748B-HF	22.0	11.5	23.0	750	0.25	0.1	16.7	41.0	205	48A
CZRA4749B-HF	24.0	10.5	25.0	750	0.25	0.1	18.2	38.0	190	49A
CZRA4750B-HF	27.0	9.5	35.0	750	0.25	0.1	20.6	34.0	170	50A
CZRA4751B-HF	30.0	8.5	40.0	1000	0.25	0.1	22.8	30.0	150	51A
CZRA4752B-HF	33.0	7.5	45.0	1000	0.25	0.1	25.1	27.0	135	52A
CZRA4753B-HF	36.0	7.0	50.0	1000	0.25	0.1	27.4	25.0	125	53A
CZRA4754B-HF	39.0	6.5	60.0	1000	0.25	0.1	29.7	23.0	115	54A
CZRA4755B-HF	43.0	6.0	70.0	1500	0.25	0.1	32.7	22.0	110	55A
CZRA4756B-HF	47.0	5.5	80.0	1500	0.25	0.1	35.8	19.0	95	56A
CZRA4757B-HF	51.0	5.0	95.0	1500	0.25	0.1	38.8	18.0	90	57A
CZRA4758B-HF	56.0	4.5	110.0	2000	0.25	0.1	42.6	16.0	80	58A
CZRA4759B-HF	62.0	4.0	125.0	2000	0.25	0.1	47.1	14.0	70	59A
CZRA4760B-HF	68.0	3.7	150.0	2000	0.25	0.1	51.7	13.0	65	60A
CZRA4761B-HF	75.0	3.3	175.0	2000	0.25	0.1	56.0	12.0	60	61A
CZRA4762B-HF	82.0	3.0	200.0	3000	0.25	0.1	62.2	11.0	55	62A
CZRA4763B-HF	91.0	2.8	250.0	3000	0.25	0.1	69.2	10.0	50	63A
CZRA4764B-HF	100.0	2.5	350.0	3000	0.25	0.1	76.0	9.0	45	64A
CZRA1110B-HF	110.0	2.3	450.0	4000	0.25	0.1	83.6	8.6	40	11Z
CZRA1120B-HF	120.0	2.0	550.0	4500	0.25	0.1	91.2	7.8	37	12Z
CZRA1130B-HF	130.0	1.9	700.0	5000	0.25	0.1	98.8	7.0	34	13Z
CZRA1150B-HF	150.0	1.7	1000.0	6000	0.25	0.1	114.0	6.4	30	15Z
CZRA1160B-HF	160.0	1.6	1100.0	6500	0.25	0.1	121.6	5.8	28	16Z
CZRA1180B-HF	180.0	1.4	1200.0	7000	0.25	0.1	136.8	5.2	25	18Z
CZRA1200B-HF	200.0	1.2	1900.0	9990	0.25	0.1	152.0	4.7	22	20Z
CZRA1220B-HF	220.0	1.0	1600.0	8000	0.25	0.1	167.2	4.0	20	22Z
CZRA1240B-HF	240.0	0.9	1800.0	8500	0.25	0.1	182.4	3.8	19	24Z
CZRA1250B-HF	250.0	0.9	2000.0	9000	0.25	0.1	190.0	3.6	18	25Z
CZRA1270B-HF	270.0	0.8	2100.0	9000	0.25	0.1	205.0	3.3	16	27Z
CZRA1300B-HF	300.0	0.8	2300.0	9500	0.25	0.1	228.0	3.0	15	30Z
CZRA1330B-HF	330.0	0.7	2500.0	9500	0.25	0.1	250.2	2.7	13	33Z

Notes:

1. The type number listed have a standard tolerance on the nominal zener voltage of ±5%.
2. The reverse surge current is a non-repetitive, 8.3ms pulse width square wave or equivalent sine-wave superimposed on I_{ZT} per JEDEC.

Company reserves the right to improve product design , functions and reliability without notice.

REV: A

Reel Taping Specification

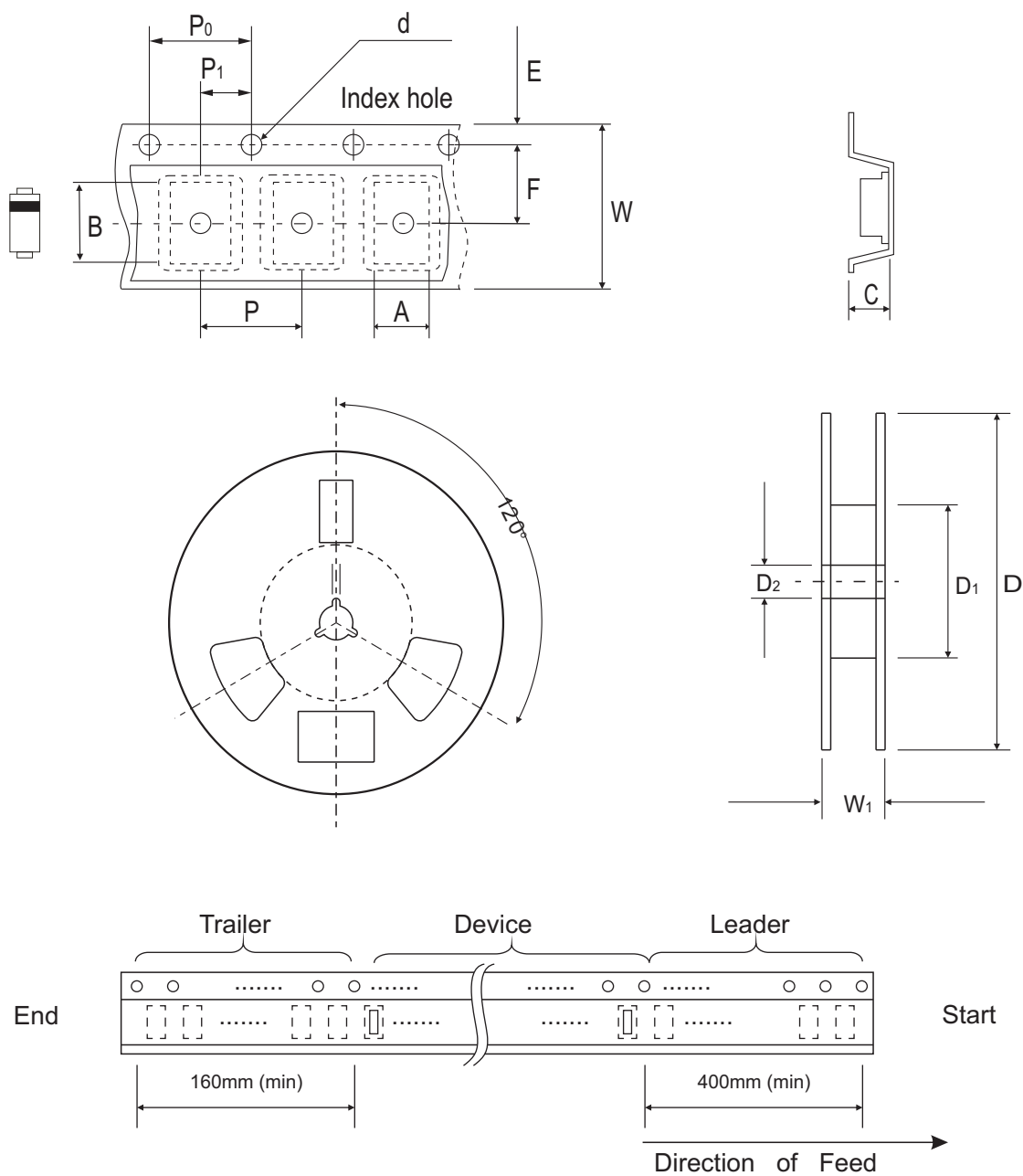

SMA/DO-214AC	SYMBOL	A	B	C	d	D	D1	D2
	(mm)	2.79 ± 0.10	5.33 ± 0.10	2.36 ± 0.10	1.75 ± 0.10	330MAX	50.0 MIN.	13.0 ± 0.2
	(inch)	0.110 ± 0.004	0.210 ± 0.004	0.093 ± 0.004	0.069 ± 0.004	13.00MAX	1.969 MIN.	0.512 ± 0.008

SMA/DO-214AC	SYMBOL	E	F	P	P0	P1	W	W1
	(mm)	1.75 ± 0.10	5.50 ± 0.05	4.00 ± 0.10	4.00 ± 0.10	2.00 ± 0.05	12.0 ± 0.30	18.4 MAX.
	(inch)	0.069 ± 0.004	0.216 ± 0.002	0.157 ± 0.004	0.157 ± 0.004	0.079 ± 0.002	0.472 ± 0.012	0.724 MAX

Company reserves the right to improve product design, functions and reliability without notice.

REV: A

Marking Code

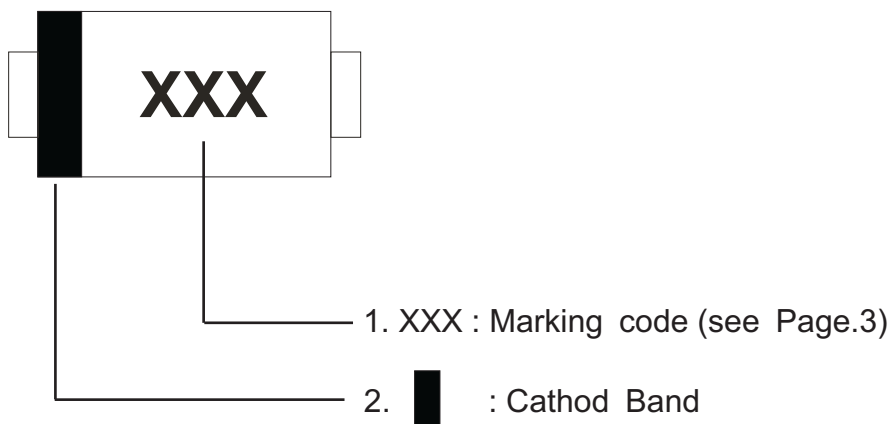

Suggested PAD Layout

SIZE	DO-214AC(SMA)	
	(mm)	(inch)
A	5.28	0.208
B	1.88 MAX	0.074 MAX
C	1.52 MIN	0.060 MIN
D	1.68 MIN	0.066 MIN

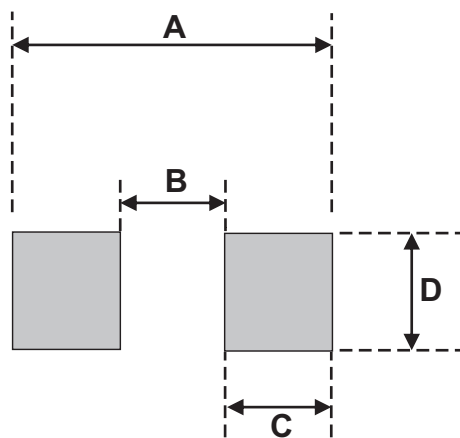

Standard Packaging

Case Type	REEL PACK	
	REEL (pcs)	Reel Size (inch)
DO-214AC (SMA)	5,000	13