

Three Channel Integrated Power Management IC for Handheld Portable Equipment

FEATURES

- Multiple Patents Pending
- Three Integrated Regulators
 - 350mA PWM Step-Down DC/DC
 - 80mA Low Noise LDO
 - 150mA Low Noise LDO
- Independent Enable/Disable Control
- Minimal External Components
- 3x3mm, Thin-QFN (TQFN33-16) Package
 - Only 0.75mm Height
 - RoHS Compliant

APPLICATIONS

- Portable Devices and PDAs
- MP3/MP4 Players
- Wireless Handhelds
- GPS Receivers, etc.

GENERAL DESCRIPTION

The patent-pending ACT8342 is a complete, cost effective, highly-efficient *ActivePMU™* power management solution that is ideal for a wide range of portable handheld equipment. This device integrates one PWM step-down DC/DC converter and two low noise, low dropout linear regulators (LDOs) in a single, thin, space-saving package. This device is ideal for a wide range of portable handheld equipment that can benefit from the advantages of *ActivePMU™* technology but does not require a high level of integration.

REG1 is a fixed-frequency, current-mode PWM step-down DC/DC converter that is optimized for high efficiency and is capable of supplying up to 350mA output current. REG1's output is available in a variety of factory-preset output voltage options, and an adjustable output voltage mode is also available. REG2 and REG3 are low noise, high PSRR linear regulators that are capable of supplying up to 80mA and 150mA, respectively.

The ACT8342 is available in a tiny 3mm x 3mm 16-pin Thin-QFN package that is just 0.75mm thin.

SYSTEM BLOCK DIAGRAM

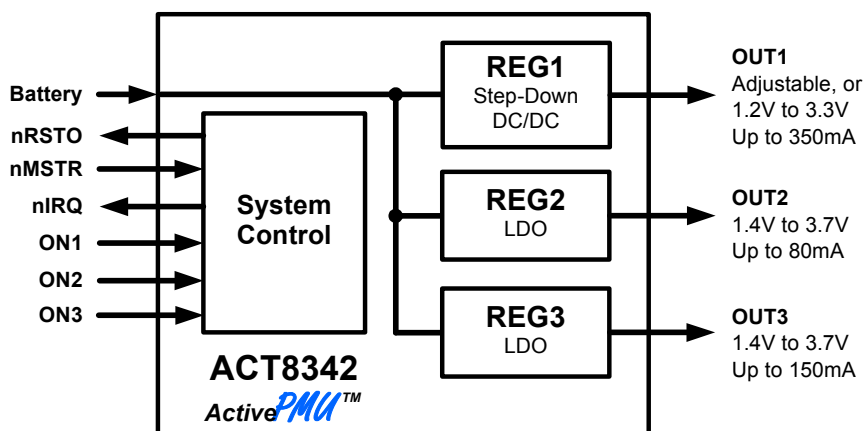

ORDERING INFORMATION^{①②}

PART NUMBER	V _{OUT1}	V _{OUT2}	V _{OUT3}	PACKAGE	PINS	TEMPERATURE RANGE
ACT8342QKCQI-T	1.2V	2.85V	2.85V	TQFN33-16	16	-40°C to +85°C
ACT8342QKP2D-T	1.2V	2.2V	2.6V	TQFN33-16	16	-40°C to +85°C

REG1 OUTPUT VOLTAGE CODES

A	C	P	J	D	E	F	I	Q	G	H
Adjustable	1.2V	1.3V	1.4V	1.5V	1.8V	2.5V	2.8V	2.85V	3.0V	3.3V

REG2 OUTPUT VOLTAGE CODES

J	D	L	E	2	F	I	Q	G	H
1.4V	1.5V	1.7V	1.8V	2.2V	2.5V	2.8V	2.85V	3.0V	3.3V

REG3 OUTPUT VOLTAGE CODES

E	G	K	M	B	D	H	I	L	R
1.4V	1.5V	1.7V	1.8V	2.5V	2.6V	2.8V	2.85V	3.0V	3.3V

①: Output voltage options detailed in this table represent standard voltage options, and are available for samples or production orders. Additional output voltage options, as detailed in the *Output Voltage Codes* table, are available for production subject to minimum order quantities. Contact Active-Semi for more information regarding semi-custom output voltage combinations.

②: All Active-Semi components are RoHS Compliant and with Pb-free plating unless specified differently. The term Pb-free means semiconductor products that are in compliance with current RoHS (Restriction of Hazardous Substances) standards.

PIN CONFIGURATION

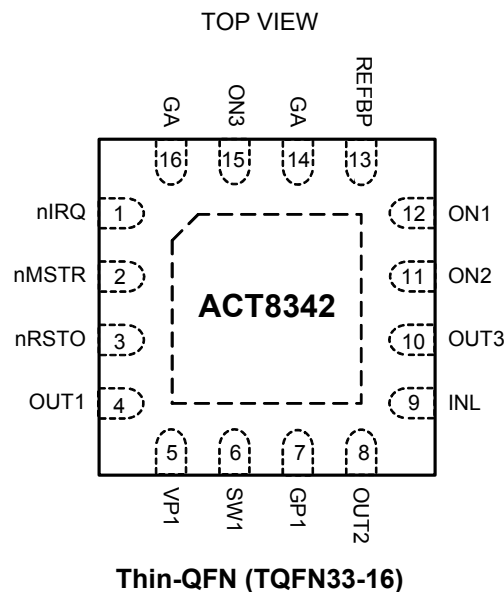

PIN DESCRIPTIONS

PIN	NAME	DESCRIPTION
1	nIRQ	Open-Drain Push-Button Status Output. nIRQ is an open-drain output which sinks current when nMSTR is asserted or when a fault-condition occurs. If interrupts are not masked.
2	nMSTR	Master Enable Input. Drive nMSTR to GA or to a logic low to enable the IC.
3	nRSTO	Open-Drain Reset Output. nRSTO asserts low for the reset timeout period of 300ms whenever the IC is enabled.
4	OUT1	Output Feedback Sense. For fixed output voltage options REG1, connect this pin directly to the output node to connect the internal feedback network to the output voltage. For adjustable output voltage Options REG1. The voltage at this pin is regulated to 0.625V. Connect this pin to the center point of the output voltage feedback network between Output Node and GA to set the output voltage.
5	VP1	Power Input for REG1. Bypass to GP1 with a high quality ceramic capacitor placed as close as possible to the IC.
6	SW1	Switching node Output for REG1. Connect this pin to the switching end of the inductor.
7	GP1	Power Ground for REG1. Connect GA, GP1 together at a single point as close to the IC as possible.
8	OUT2	Output voltage for REG2. Capable of delivering up to 80mA of output current. Output is discharged to ground with 650Ω resistor when disabled.
9	INL	Power input for REG2, REG3. Bypass to GA with a high quality ceramic capacitor placed as close as possible to the IC.
10	OUT3	Output voltage for REG3. Capable of delivering up to 150mA of output current. Output is discharged to ground with 650Ω resistor when disabled.
11	ON2	Enable Control Input for REG2. Drive ON2 to INL or to a logic high for normal operation, drive to GA or a logic low to disable REG2.
12	ON1	Enable control input for REG1. Drive ON1 to the VP1 or a logic high for normal operation, drive to GA or a logic low to disable REG1.
13	REFBP	Reference Noise Bypass. Connect a 0.01μF ceramic capacitor from REFBP to GA. This pin is discharged to GA in shutdown.
14, 16	GA	Analog Ground. Connect GA directly to a quiet ground node. Connect GA, GP1 together at a single point as close to the IC as possible.
15	ON3	Enable control input for REG3. Drive ON3 to the INL or a logic high for normal operation, drive to GA or a logic low to disable REG3.

ABSOLUTE MAXIMUM RATINGS^①

PARAMETER	VALUE	UNIT
SW1 to GP1, INL, VP1, OUT1, OUT2, OUT3, ON1, ON2, ON3, nMSTR, nRSTO, nIRQ, REFBP to GA	-0.3 to +6	V
SW1 to VP1	-6 to +0.3	V
GP1 to GA	-0.3 to +0.3	V
Junction to Ambient Thermal Resistance (θ_{JA})	33	°C/W
Operating Temperature Range	-40 to 85	°C
Junction Temperature	125	°C
Storage Temperature	-55 to 150	°C
Lead Temperature (Soldering, 10 sec)	300	°C

①: Do not exceed these limits to prevent damage to the device. Exposure to absolute maximum rating conditions for long periods may affect device reliability.

ELECTRICAL CHARACTERISTICS

($V_{INL} = 3.6V$, $T_A = 25^\circ C$, unless otherwise specified.)

PARAMETER	TEST CONDITIONS	MIN	TYP	MAX	UNIT
INL Operating Voltage Range		2.7		5.5	V
INL UVLO Threshold	INL Voltage Rising	2.25	2.5	2.7	V
INL UVLO Hysteresis	INL Voltage Falling		90		mV
Oscillator Frequency		1.35	1.6	1.85	MHz
INL Supply Current	ON1 = ON2 = ON3 = GA		1.5		μA
nMSTR Internal Pull-Up Resistance		250	500		k Ω
Logic High Input Voltage	ON1, ON2, ON3, nMSTR	1.4			V
Logic Low Input Voltage	ON1, ON2, ON3, nMSTR			0.4	V
Logic Low Output Voltage	$I_{SINK} = 5mA$			0.3	V
Leakage Current	nIRQ, nRSTO, $V_{nRSTO} = V_{nIRQ} = 4.2V$			1	μA
nRSTO Delay		240	300	360	ms
Thermal Shutdown Temperature	Temperature rising		160		$^\circ C$
Thermal Shutdown Hysteresis	Temperature falling		20		$^\circ C$

FUNCTIONAL DESCRIPTION

General Description

The ACT8342 offers an array of system management functions that allow it to provide optimal performance in a wide range of applications.

System Startup and Shutdown

The ACT8342 features a flexible control architecture that supports a variety of software-controlled enable/disable functions that make it a simple yet flexible and highly configurable solution.

The ACT8342 is automatically enabled when any of the following conditions exists:

- 1) nMSTR is asserted low, or
- 2) ON1 is asserted high, or
- 3) ON2 is asserted high, or
- 4) ON3 is asserted high.

If any of these conditions is true, the ACT8342 enables and ON1 drives REG1, ON2 drives REG2, and ON3 drives REG3.

Manual Enable Due to Asserting nMSTR Low

System startup is initiated when the user presses the push-button, asserting nMSTR low. When this occurs, REG1 is enabled, which in turn enables the processor to allow it to control the system power up sequence. Once the power-up routine is successfully completed, the microprocessor must assert ON1 so that the ACT8342 remains enabled after the push-button is released by the user. Upon completion of the start-up sequence the processor assumes control of the power system and all further operation is software-controlled.

Manual Enable Due to Asserting ON1 High

The ACT8342 is compatible with applications that do not utilize its push-button control function, and may be enabled by simply driving ON1 to a logic-high. In this case, the signal driving ON1 controls enable/disable timing, although software-controlled enable/disable sequences are still supported if the processor assumes control of the power system once the startup sequence is completed.

Shutdown Sequence

Once a successful power-up routine is completed, the system processor controls the operation of the power system, including the system shutdown

timing and sequence. The ACT8342 asserts nIRQ low when nMSTR is asserted low, providing a simple means of alerting the system processor when the user wishes to shut the system down. Asserting nIRQ interrupts the system processor, initiating an interrupt service routine in the processor which will reveal that the user pressed the push-button. The microprocessor may validate the input, such as by ensuring that the push-button is asserted for a minimum amount of time, then initiates a software-controlled power-down routine, the final step of which is to de-assert the ON1 input, disabling REG1 and REG2 and shutting the system down.

nMSTR Enable Input

In most applications, connect nMSTR to an active low, momentary push-button switch to utilize the ACT8342's closed-loop enable/disable functionality. If a momentary-on switch is not used, drive nMSTR to GA or to a logic low to initiate a startup sequence.

Enable/Disable Inputs

The ACT8342 provides three manual enable/disable inputs. When driven high, ON1 enables REG1, ON2 enables REG2, and ON3 enables OUT3.

nIRQ Output

The ACT8342 provides an active-low, open-drain push-button status output that sinks current when nMSTR is driven to a logic-low. Connect a pull-up resistor from nIRQ to an appropriate voltage supply. nIRQ is typically used to drive the interrupt input of the system processor, and is useful in a variety of software-controlled enable/disable control routines.

Thermal Shutdown

The ACT8342 integrates thermal shutdown protection circuitry to prevent damage resulting from excessive thermal stress, as may be encountered under fault conditions. This circuitry disables all regulators if the ACT8342 die temperature exceeds 160°C, and prevents the regulators from being enabled until the IC temperature drops by 20°C (typ).

TYPICAL PERFORMANCE CHARACTERISTICS

($V_{INL} = 3.6V$, $T_A = 25^\circ C$, unless otherwise specified.)

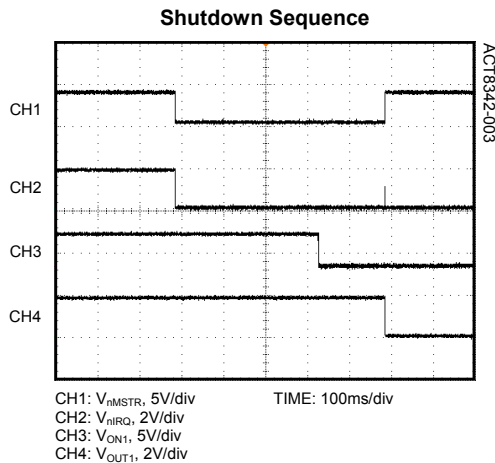
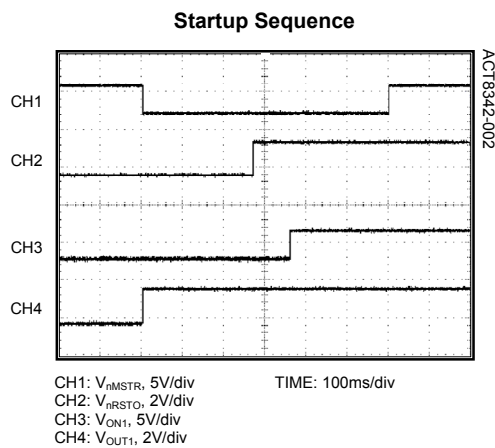
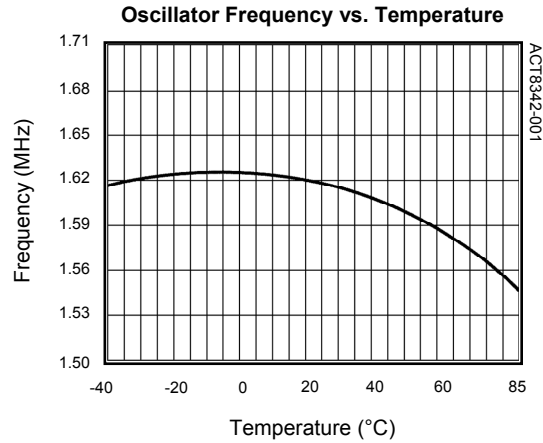

STEP-DOWN DC/DC CONVERTER

ELECTRICAL CHARACTERISTICS (REG1)

($V_{VP1} = 3.6V$, $T_A = 25^\circ C$, unless otherwise specified.)

PARAMETER	TEST CONDITIONS	MIN	TYP	MAX	UNIT
VP1 Operating Voltage Range		3.1		5.5	V
VP1 UVLO Threshold	Input Voltage Rising	2.9	3	3.1	V
VP1 UVLO Hysteresis	Input Voltage Falling		90		mV
Standby Supply Current			130	200	μA
Shutdown Supply Current	ON1 = GA, $V_{VP1} = 4.2V$		0.1	1	μA
Adjustable Output Option Regulation Voltage			0.625		V
Output Voltage Regulation Accuracy	$V_{NOM1} < 1.3V$, $I_{OUT1} = 10mA$	-2.4%	$V_{NOM1}^{\text{①}}$	+1.8%	V
	$V_{NOM1} \geq 1.3V$, $I_{OUT1} = 10mA$	-1.2%	V_{NOM1}	+1.8%	
Line Regulation	$V_{VP1} = \text{Max}(V_{NOM1} + 1V, 3.2V)$ to 5.5V		0.15		%/V
Load Regulation	$I_{OUT1} = 10mA$ to 350mA		0.0017		%/mA
Current Limit		0.45	0.6		A
Oscillator Frequency	$V_{OUT1} \geq 20\%$ of V_{NOM1}	1.35	1.6	1.85	MHz
	$V_{OUT1} = 0V$		530		kHz
PMOS On-Resistance	$I_{SW1} = -100mA$		0.52	0.88	Ω
NMOS On-Resistance	$I_{SW1} = 100mA$		0.27	0.46	Ω
SW1 Leakage Current	$V_{VP1} = 5.5V$, $V_{SW1} = 5.5V$ or 0V			1	μA
Power Good Threshold			94		% V_{NOM1}
Minimum On-Time			70		ns

①: V_{NOM1} refers to the nominal output voltage level for V_{OUT1} as defined by the *Ordering Information* section.

STEP-DOWN DC/DC CONVERTER

TYPICAL PERFORMANCE CHARACTERISTICS

(ACT8342QKQCI, $V_{VP1} = 3.6V$, $L = 3.3\mu H$, $C_{VP1} = 2.2\mu F$, $C_{OUT1} = 10\mu F$, $T_A = 25^\circ C$, unless otherwise specified.)

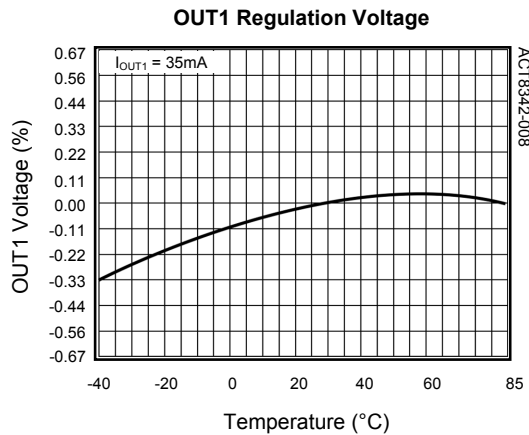
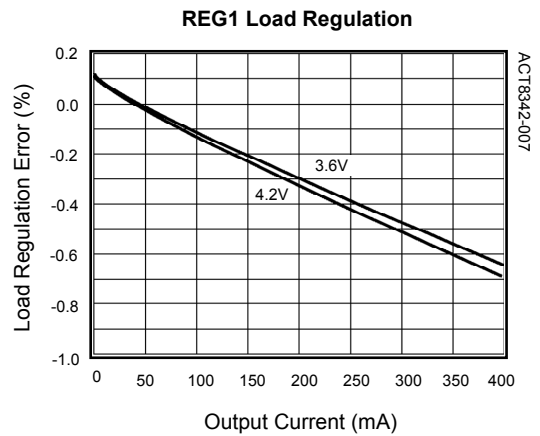
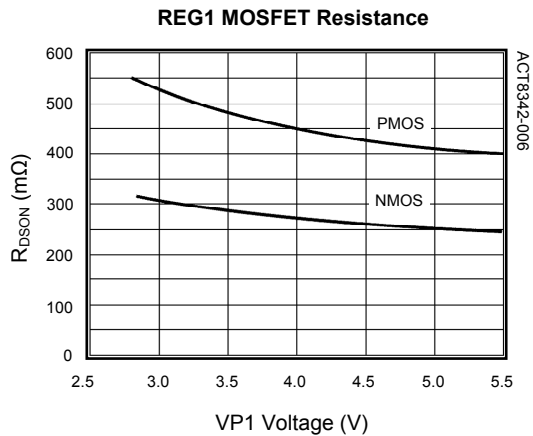
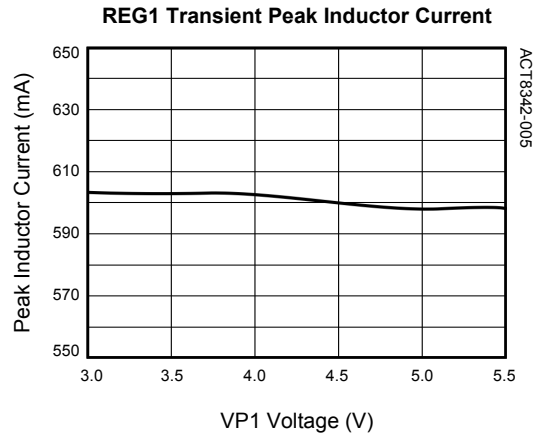
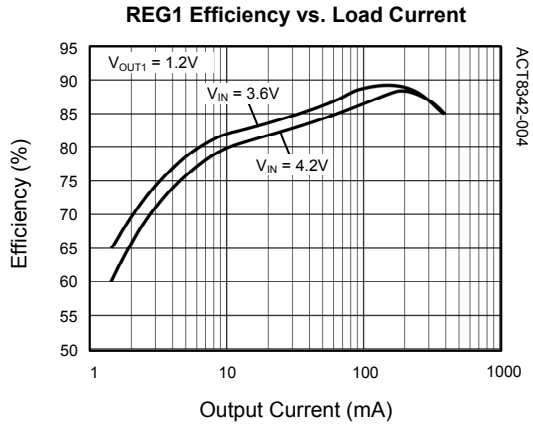

STEP-DOWN DC/DC CONVERTER

FUNCTIONAL DESCRIPTION

General Description

REG1 is a fixed-frequency, current-mode, synchronous PWM step-down converters that achieves a peak efficiency of up to 97%. REG1 is capable of supplying up to 350mA of output current and operates with a fixed frequency of 1.6MHz, minimizing noise in sensitive applications and allowing the use of small external components. REG1 is available with a variety of standard and custom output voltages, as well as an adjustable output voltage option.

100% Duty Cycle Operation

REG1 is capable of operating at up to 100% duty cycle. During 100% duty-cycle operation, the high-side power MOSFET is held on continuously, providing a direct connection from the input to the output (through the inductor), ensuring the lowest possible dropout voltage in battery-powered applications.

Synchronous Rectification

REG1 features an integrated n-channel synchronous rectifier, which maximizes efficiency and minimizes the total solution size and cost by eliminating the need for an external rectifier.

Enabling and Disabling REG1

REG1 is enabled or disabled using ON1. Drive ON1 to a logic-high to enable REG1. Drive ON1 to a logic-low to disable REG1, reducing supply current to less than 1µA.

Soft-Start

REG1 includes internal soft-start circuitry, and enabled its output voltage tracks an internal 80µs soft-start ramp so that it powers up in a monotonic manner that is independent of loading.

Compensation

REG1 utilizes current-mode control and a proprietary internal compensation scheme to simultaneously simplify external component selection and optimize transient performance over its full operating range. No compensation design is required, simply follow a few simple guidelines described below when choosing external components.

Input Capacitor Selection

The input capacitor reduces peak currents and noise induced upon the voltage source. A 2.2µF ceramic input capacitor is recommended for most applications.

Output Capacitor Selection

For most applications, a 10µF ceramic output capacitor is recommended. Although REG1 was designed to take advantage of the benefits of ceramic capacitors, namely small size and very-low ESR, low-ESR tantalum capacitors can provide acceptable results as well.

Inductor Selection

REG1 utilizes current-mode control and a proprietary internal compensation scheme to simultaneously simplify external component selection and optimize transient performance over its full operating range. REG1 was optimized for operation with a 3.3µH inductor, although inductors in the 2.2µH to 4.7µH range can be used. Choose an inductor with a low DC-resistance, and avoid inductor saturation by choosing inductors with DC ratings that exceed the maximum output current of the application by at least 30%.

Thermal Shutdown

The ACT8342 integrates thermal shutdown protection circuitry to prevent damage resulting from excessive thermal stress, as may be encountered under fault conditions. This circuitry disables all regulators if the ACT8342 die temperature exceeds 160°C, and prevents the regulators from being enabled until the IC temperature drops by 20°C (typ).

Output Voltage Programming

Figure 4 shows the feedback network necessary to set the output voltage when using the adjustable output voltage option. Select components as follows: Set $R_{FB2} = 51K\Omega$, then calculate R_{FB1} using the following equation:

$$R_{FB1} = R_{FB2} \left(\frac{V_{OUT1}}{V_{FB}} - 1 \right) \quad (1)$$

Where V_{FB} is 0.625V

Figure 4:
Output Voltage Programming

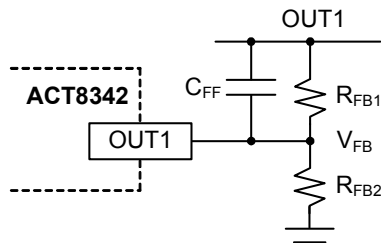

Finally choose C_{FF} using the following equation:

$$C_{FF} = \frac{2.2 \times 10^{-6}}{R_{FB1}} \quad (2)$$

where $R_{FB1} = 47k\Omega$, use 47pF.

PCB Layout Considerations

High switching frequencies and large peak currents make PC board layout an important part of step-down DC/DC converter design. A good design minimizes excessive EMI on the feedback paths and voltage gradients in the ground plane, both of which can result in instability or regulation errors. Step-down DC/DCs exhibit discontinuous input current, so the input capacitors should be placed as close as possible to the IC, and avoiding the use of vias if possible. The inductor, input filter capacitor, and output filter capacitor should be connected as close together as possible, with short, direct, and wide traces. The ground nodes for each regulator's power loops should be connected at a single point in a star-ground configuration, and this point should be connected to the backside ground plane with multiple vias. For fixed output voltage options, connect the output node directly to the OUT1 pin. For adjustable output voltage options, connect the feedback resistors and feed-forward capacitor to the OUT1 pin through the shortest possible route. In both cases, the feedback path should be routed to maintain sufficient distance from switching nodes to prevent noise injection. Finally, the exposed pad should be directly connected to the backside ground plane using multiple vias to achieve low electrical and thermal resistance.

LOW-DROPOUT LINEAR REGULATORS

ELECTRICAL CHARACTERISTICS (REG2)

($V_{INL} = 3.6V$, $C_{OUT2} = 1\mu F$, $T_A = 25^\circ C$, unless otherwise specified.)

PARAMETER	TEST CONDITIONS	MIN	TYP	MAX	UNIT
INL Operating Voltage Range		3.1		5.5	V
INL UVLO Threshold	V_{INL} Input Rising	2.9	3	3.1	V
UVLO Hysteresis	V_{INL} Input Falling		0.1		V
Output Voltage Accuracy	$T_A = 25^\circ C$	-1.2	V_{NOM2} ^①	+2	%
	$T_A = -40^\circ C$ to $85^\circ C$	-2.5	V_{NOM2}	+3	
Line Regulation Error	$V_{INL} = \text{Max}(V_{OUT2} + 0.5V, 3.6V)$ to 5.5V		0		mV
Load Regulation Error	$I_{OUT2} = 1mA$ to 80mA		-0.004		%/mA
Power Supply Rejection Ratio	$f = 1kHz$, $I_{OUT2} = 80mA$, $C_{OUT2} = 1\mu F$		70		dB
	$f = 10kHz$, $I_{OUT2} = 80mA$, $C_{OUT2} = 1\mu F$		60		
Supply Current per Output	Regulator Enabled		50		μA
	Regulator Disabled		0		
Dropout Voltage ^②	$I_{OUT2} = 40mA$, $V_{OUT2} > 3.1V$		100	200	mV
Output Current				80	mA
Current Limit ^③	$V_{OUT2} = 95\%$ of regulation voltage	90			mA
Internal Soft-Start			100		μs
Power Good Flag High Threshold	V_{OUT2} , hysteresis = -4%		89		%
Output Noise	$C_{OUT2} = 10\mu F$, $f = 10Hz$ to 100kHz		40		μV_{RMS}
Stable C_{OUT2} Range		1		20	μF
Discharge Resistor in Shutdown	LDO Disabled		650		Ω

①: V_{NOM2} refers to the nominal output voltage level for V_{OUT2} as defined by the *Ordering Information* section.

②: Dropout Voltage is defined as the differential voltage between input and output when the output voltage drops 100mV below the regulation voltage at 1V differential voltage.

③: LDO current limit is defined as the output current at which the output voltage drops to 95% of the respective regulation voltage. Under heavy overload conditions the output current limit folds back by 30% (typ)

LOW-DROPOUT LINEAR REGULATORS

ELECTRICAL CHARACTERISTICS (REG3)

($V_{INL} = 3.6V$, $C_{OUT3} = 1\mu F$, $T_A = 25^\circ C$, unless otherwise specified.)

PARAMETER	TEST CONDITIONS	MIN	TYP	MAX	UNIT
INL Operating Voltage Range		3.1		5.5	V
INL UVLO Threshold	V_{INL} Input Rising	2.9	3	3.1	V
UVLO Hysteresis	V_{INL} Input Falling		0.1		V
Output Voltage Accuracy	$T_A = 25^\circ C$	-1.2	$V_{NOM3}^{\textcircled{1}}$	+2	%
	$T_A = -40^\circ C$ to $85^\circ C$	-2.5	V_{NOM3}	+3	
Line Regulation Error	$V_{INL} = \text{Max}(V_{OUT3} + 0.5V, 3.6V)$ to 5.5V		0		mV
Load Regulation Error	$I_{OUT3} = 1mA$ to 150mA		-0.004		%/mA
Power Supply Rejection Ratio	$f = 1kHz$, $I_{OUT3} = 150mA$, $C_{OUT3} = 1\mu F$		70		dB
	$f = 10kHz$, $I_{OUT3} = 150mA$, $C_{OUT3} = 1\mu F$		60		
Supply Current per Output	Regulator Enabled		50		μA
	Regulator Disabled		0		
Dropout Voltage ^②	$I_{OUT3} = 80mA$, $V_{OUT3} > 3.1V$		100	200	mV
Output Current				150	mA
Current Limit ^③	$V_{OUT3} = 95\%$ of regulation voltage	170			mA
Internal Soft-Start			100		μs
Power Good Flag High Threshold	V_{OUT3} , hysteresis = -4%		89		%
Output Noise	$C_{OUT3} = 10\mu F$, $f = 10Hz$ to 100kHz		40		μV_{RMS}
Stable C_{OUT3} Range		1		20	μF
Discharge Resistor in Shutdown	LDO Disabled		650		Ω

①: V_{NOM3} refers to the nominal output voltage level for V_{OUT2} as defined by the *Ordering Information* section.

②: Dropout Voltage is defined as the differential voltage between input and output when the output voltage drops 100mV below the regulation voltage at 1V differential voltage.

③: LDO current limit is defined as the output current at which the output voltage drops to 95% of the respective regulation voltage. Under heavy overload conditions the output current limit folds back by 30% (typ)

LOW-DROPOUT LINEAR REGULATORS

TYPICAL PERFORMANCE CHARACTERISTICS

(ACT8342QKCQI, $V_{INL} = 5V$, $T_A = 25^\circ C$, unless otherwise specified.)

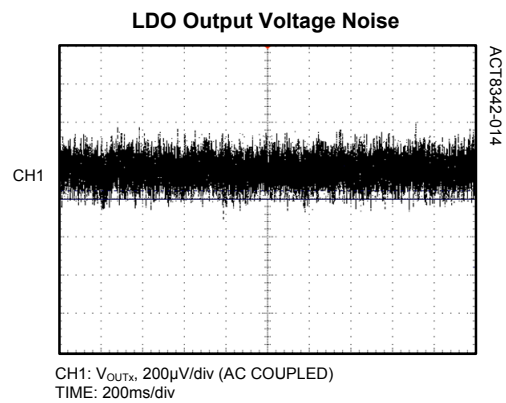
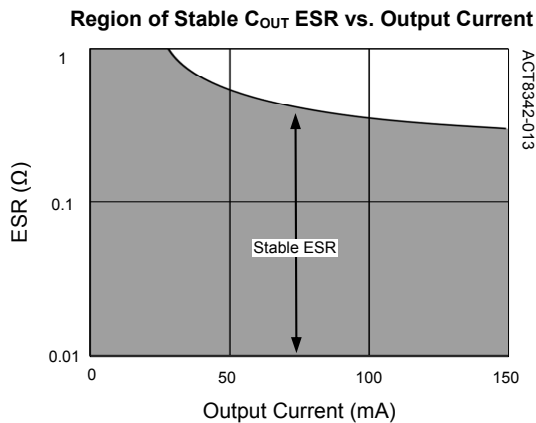
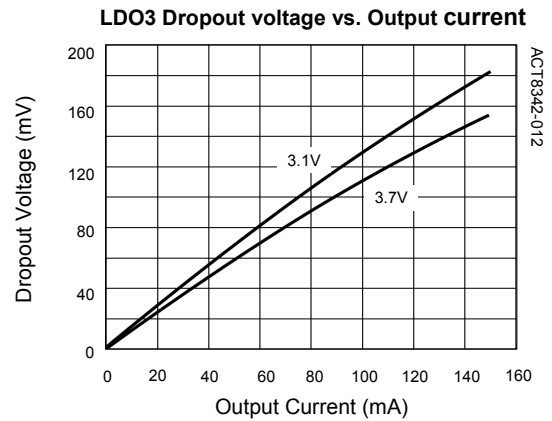
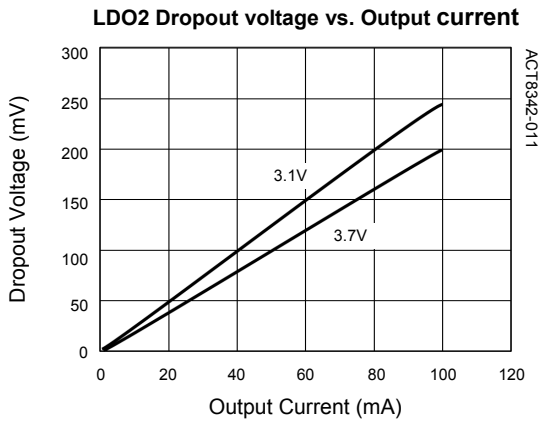
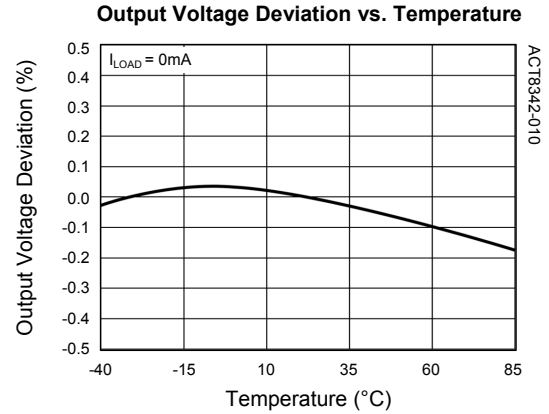
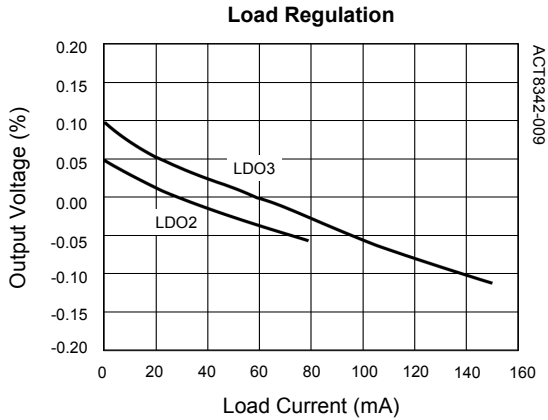

LOW-DROPOUT LINEAR REGULATORS**FUNCTIONAL DESCRIPTION****General Description**

REG2 and REG3 are low-noise, low-dropout linear regulators (LDOs) that are optimized for low-noise and high-PSRR operation, achieving more than 60dB PSRR at frequencies up to 10kHz.

Output Current Capability

REG2 supplies up to 80mA while REG3 supplies up to 150mA of load current. Excellent performance is achieved over each regulator's entire load current ranges.

Output Current Limit

In order to ensure safe operation under over-load conditions, each LDO features current-limit circuitry with current fold-back. The current-limit circuitry limits the current that can be drawn from the output, providing protection in over-load conditions. For additional protection under extreme over current conditions, current-fold-back protection reduces the current-limit by approximately 30% under extreme overload conditions.

Enabling and Disabling the LDOs

REG2 and REG3 are enabled or disabled using ON2 and ON3. Drive ON2 and ON3 to a logic-high to enable REG2 and REG3. Drive ON2 and ON3 to a logic-low to disable REG2 and REG3, reducing supply current to less than 1 μ A.

Output Capacitor Selection

REG2 and REG3 each require only a small ceramic capacitor for stability. For best performance, each output capacitor should be connected directly between the OUT2 and OUT3 and G pins as possible, with a short and direct connection. To ensure best performance for the device, the output capacitor should have a minimum capacitance of 1 μ F, and ESR value between 10m Ω and 200m Ω . High quality ceramic capacitors such as X7R and X5R dielectric types are strongly recommended.

PCB Layout Considerations

The ACT8342's LDOs provide good DC, AC, and noise performance over a wide range of operating conditions, and are relatively insensitive to layout considerations. When designing a PCB, however, careful layout is necessary to prevent other circuitry from degrading LDO performance.

A good design places input and output capacitors as close to the LDO inputs and output as possible, and utilizes a star-ground configuration for all regulators to prevent noise-coupling through ground. Output traces should be routed to avoid close proximity to noisy nodes, particularly the SW nodes of the DC/DCs.

PACKAGE OUTLINE

TQFN33-16 PACKAGE OUTLINE AND DIMENSIONS

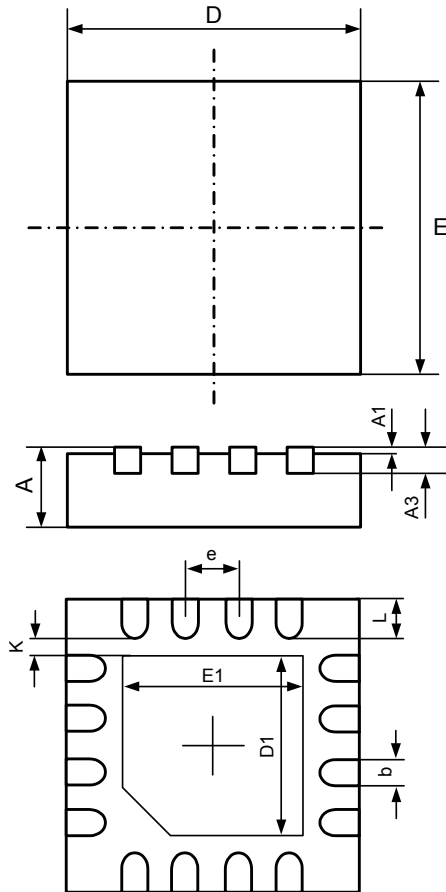

SYMBOL	DIMENSION IN MILLIMETERS		DIMENSION IN INCHES	
	MIN	MAX	MIN	MAX
A	0.700	0.800	0.028	0.031
A1	0.000	0.050	0.000	0.002
A3	0.153	0.253	0.006	0.010
D	2.900	3.100	0.114	0.122
E	2.900	3.100	0.114	0.122
D2	1.600	1.800	0.063	0.071
E2	1.600	1.800	0.063	0.071
b	0.180	0.300	0.007	0.012
e	0.500 TYP		0.020 TYP	
L	0.300	0.500	0.012	0.020
K	0.200	0.400	0.008	0.016

Active-Semi, Inc. reserves the right to modify the circuitry or specifications without notice. Users should evaluate each product to make sure that it is suitable for their applications. Active-Semi products are not intended or authorized for use as critical components in life-support devices or systems. Active-Semi, Inc. does not assume any liability arising out of the use of any product or circuit described in this datasheet, nor does it convey any patent license.

Active-Semi and its logo are trademarks of Active-Semi, Inc. For more information on this and other products, contact sales@active-semi.com or visit <http://www.active-semi.com>. For other inquiries, please send to:

1270 Oakmead Parkway, Suite 310, Sunnyvale, California 94085-4044, USA