

Bi-Directional Triode Thyristor

- High current density due to double mesa technology, SIPOS and Glass passivation .
BT20F series triacs is suitable for general purpose AC switching. They can be used as an ON/OFF function in applications such as static relays, heating regulation, induction motor starting circuits or phase control operation light dimmers, motorspeed controllers.
- BT20F series are 3 Quadrants triacs, They are specially recommended for use on inductive loads.

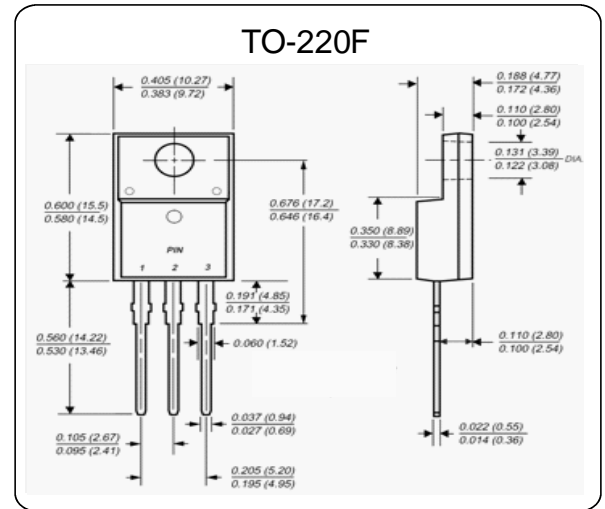

Features

- Blocking Voltage to 800 V
- On- State Current Rating of 20A RMS at 90 °C
- Uniform Gate Trigger Currents in Three Quadrants
- High Immunity to dV/dt- 1500V/us minimum at 125 °C
- Minimizes Snubber Networks for Protection
- Industry Standard TO- 220F Package
- High Commutating dI/dt- 4.0A/ms minimum at 125 °C
- Internally Isolated (2500VRMS)
- These are Pb- Free Devices

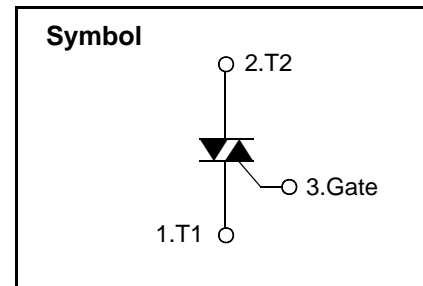

Absolute Maximum Ratings

Parameter	Symbol	Value	Unit	
Storage junction temperature range	T _{stg}	-40 to +150	°C	
Operating junction temperature range	T _j	-40 to + 125	°C	
Repetitive Peak OFF-state Voltage	V _{DRM}	800	V	
Repetitive Peak Reverse Voltage	V _{RDM}	800	V	
Non repetitive surge peak off-state voltage	V _{DSM}	700 and 900	V	
Non repetitive peak reverse voltage	V _{RSM}	700 and 900	V	
RMS on-state current(full sine wave)	I _{T(RMS)}	TC=90°C	20	A
		TC=70°C	20	A
Non repetitive surge peak on-state current(full cycle, T _J =25°C)	I _{TSM}	f=60Hz, t=16.7ms	210	A
		f=50Hz, t=20ms	200	A
I ² t Value for fusing	I ² t	200	A ² s	
Critical rate of rise of on-state current I _G =2*I _{GT} , t _r ≤100ns, f=120Hz, T _J =125°C	di/dt	100	A/us	
Peak gate current(tp=20us, T _J =125°C)	I _{GM}	4	A	
Peak gate power dissipation(tp=20us, T _J =125°C)	P _{GM}	10	W	
Average gate power dissipation(T _J =125°C)	P _{G(AV)}	1	W	



BT20F-800B

Electrical Characteristics (T_j=25°C, unless otherwise specified)

Symbol	Test Condition	Quadrant		Limit		Unit
				CW(C)	BW(B)	
I _{GT}	V _D =12V, R _L =33Ω	I - II - III - IV	MAX	35	50	mA
V _{GT}		I - II - III - IV	MAX	1.5		V
V _{GD}	V _D =V _{DRM} R _L =3.3KΩ T _j =125°C	I - II - III - IV	MIN	0.2		V
I _L	I _G =1.2I _{GT}	I - III - IV	MAX	50	70	mA
		II	MAX	60	80	mA
I _H	I _T =100mA		MAX	40	60	mA
Dv/dt	V _D =67%V _{DRM} gate open T _J =125°C		MIN	250	500	V/us
(Dv/dt) _C	(di/dt) _C =8.8A/ms T _j =125°C		MIN	7	12.5	V/us

Static Characteristics

Symbol	Parameter		Value(MAX)	Unit
V _{TM}	I _{TM} =28A, t _p =380us	T _j =25°C	1.55	V
I _{DRM}	V _D =V _{DRM} V _R =V _{RRM}	T _j =25°C	5	uA
I _{RRM}		T _j =125°C	2.5	mA

Thermal Resistances

Symbol	Parameter	Value	Unit
R _{th} (J-C)	Junction to case(AC)	2.1	°C/W

Voltage Current Characteristic of Triacs (Bidirectional Device)

Symbol	Parameter
V_{DRM}	Peak Repetitive Forward Off State Voltage
I_{DRM}	Peak Forward Blocking Current
V_{RRM}	Peak Repetitive Reverse Off State Voltage
I_{RRM}	Peak Reverse Blocking Current
V_{TM}	Maximum On State Voltage
I_H	Holding Current

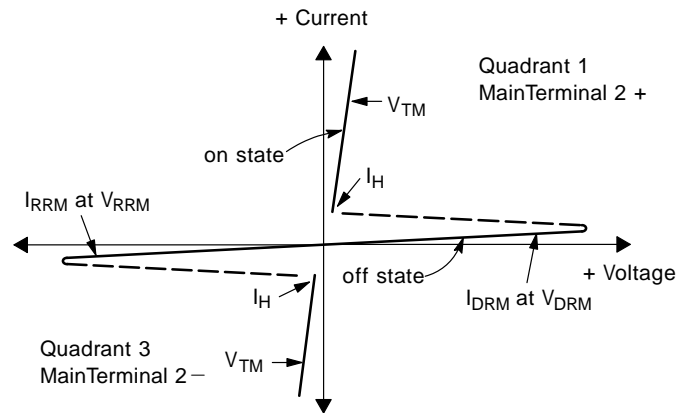

Quadrant Definitions for a Triac

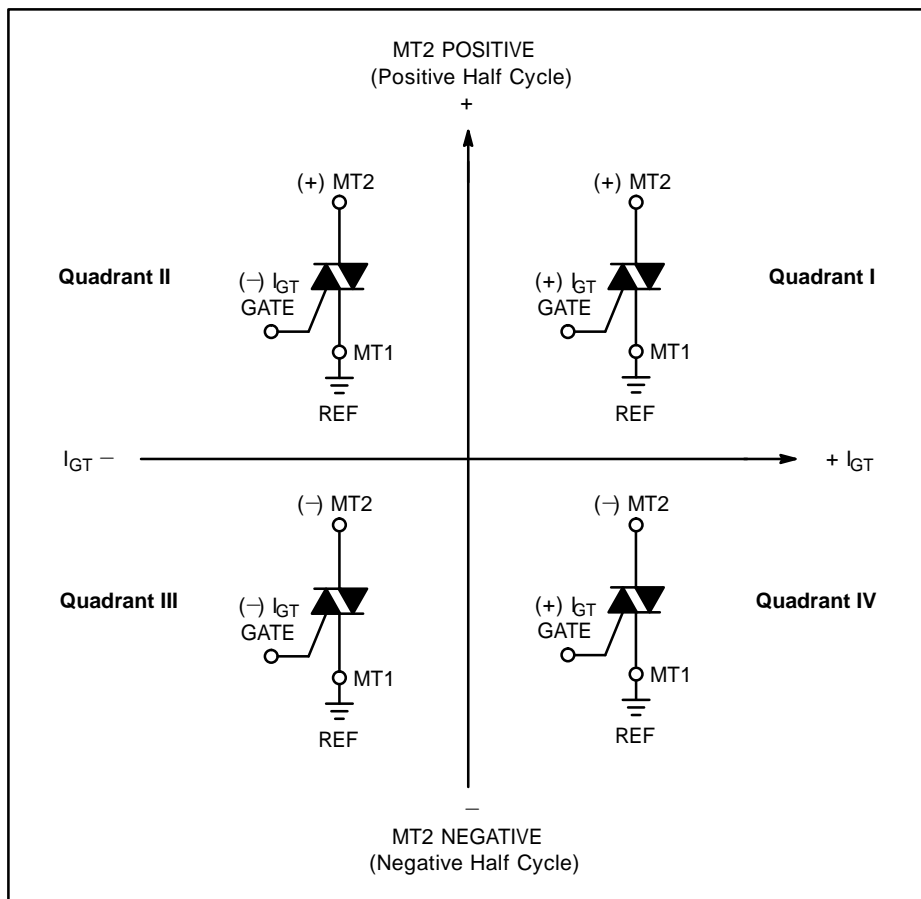

All polarities are referenced to MT1.
 With in-phase signals (using standard AC lines) quadrants I and III are used.

Fig. 1: Maximum RMS power dissipation versus RMS on-state current ($F = 50\text{Hz}$). (Curves are cut off by $(di/dt)_c$ limitation)

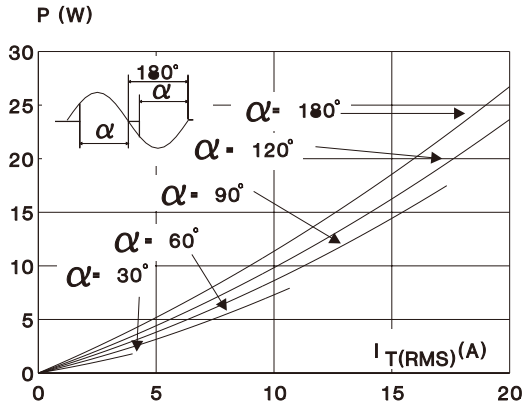

Fig. 2: Correlation between maximum RMS power dissipation and maximum allowable temperatures (T_{amb} and T_{case}) for different thermal resistances heatsink + contact (BTA).

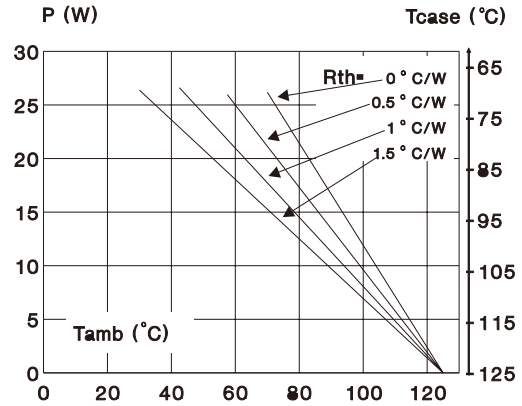

Fig. 3: Correlation between maximum RMS power dissipation and maximum allowable temperatures (T_{amb} and T_{case}) for different thermal resistances heatsink + contact (BTB).

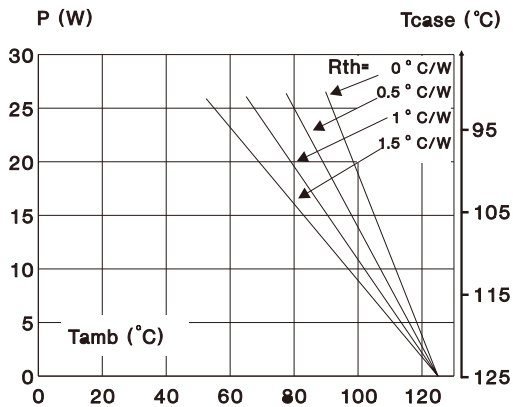

Fig. 4: RMS on-state current versus case temperature.

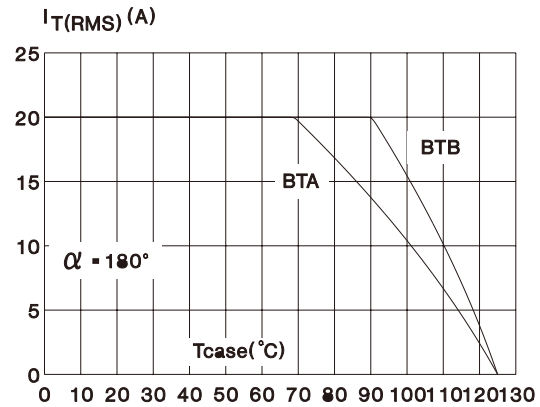

Fig. 5: Relative variation of thermal impedance versus pulse duration.

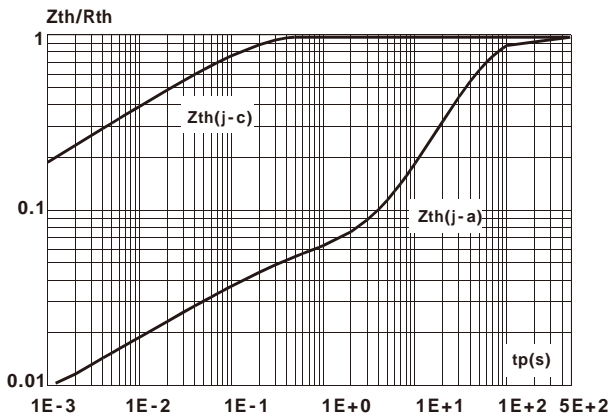

Fig. 6: Relative variation of gate trigger current and holding current versus junction temperature.

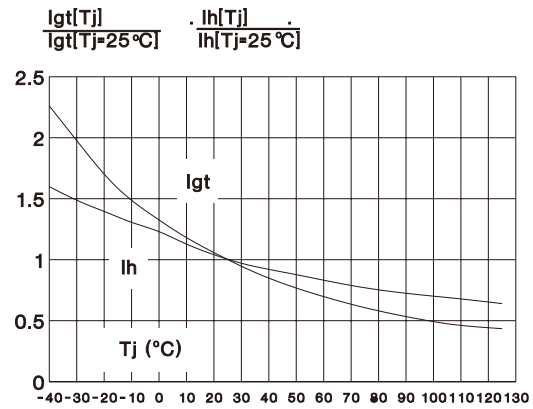

Fig. 7: Non repetitive surge peak on -state current versus number of cycles.

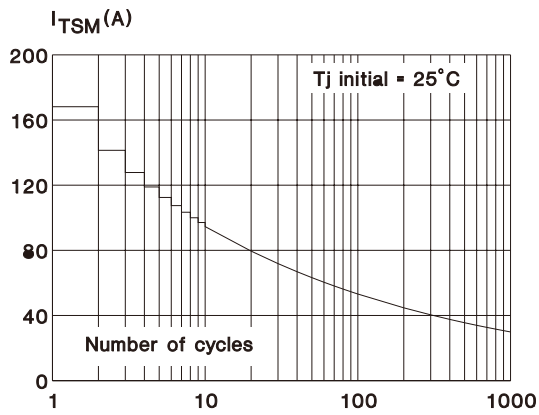

Fig. 8: Non repetitive surge peak on -state current for a sinusoidal pulse with width: $t \leq 10\text{ms}$, and corresponding value of I^2t .

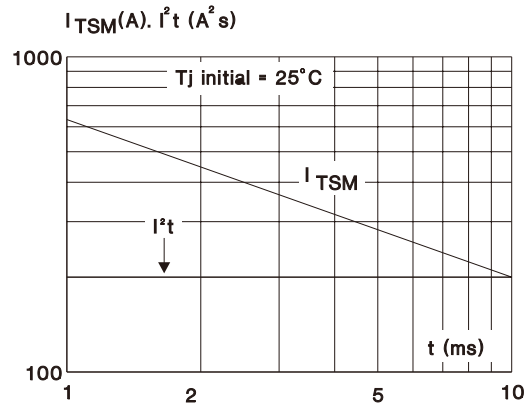

Fig. 9: On -state characteristics (maximum values).

