

T-79-07-10

Features

- 100 MHz Gain Bandwidth Product ($A_v = 5$)
- 500 M Ω Input Impedance
- 500 μ V Input Offset Voltage
- 150K V/V Open Loop Voltage Gain

Applications

- Video Amplifiers
- Pulse Amplifiers
- High Speed Comparators
- Low Distortion Oscillators
- High-Q Active Filters

Description

The SP-2620/22/25 are uncompensated, wide bandwidth operational amplifiers. They are stable for gains of five (5) or greater. In addition to their wide bandwidth, the SP-2620/22/25 offer the advantages of high input impedance, low input bias, input offset currents, low input offset voltage, and short circuit protection. These characteristics combined with the option for complete control of the amplifier's compensation to make it a superior amplifier for high frequency analog signal applications.

These amplifiers provide the designer with the ability to tailor its transfer characteristics through compensation. Offsets can also be trimmed by connecting a nulling potentiometer between its balance pins, and connecting the wiper to the positive supply, V^+ . A 100K Ω potentiometer is recommended.

The SP-2620 and the SP-2622 are offered in military (-55°C to 125°C) versions; both are available in metal can, ceramic mini DIP, and LCC packages as well as in die form. The SP-2625 is offered in plastic, ceramic mini DIP, and metal can packages as well as in die form.

4

Connection Diagrams

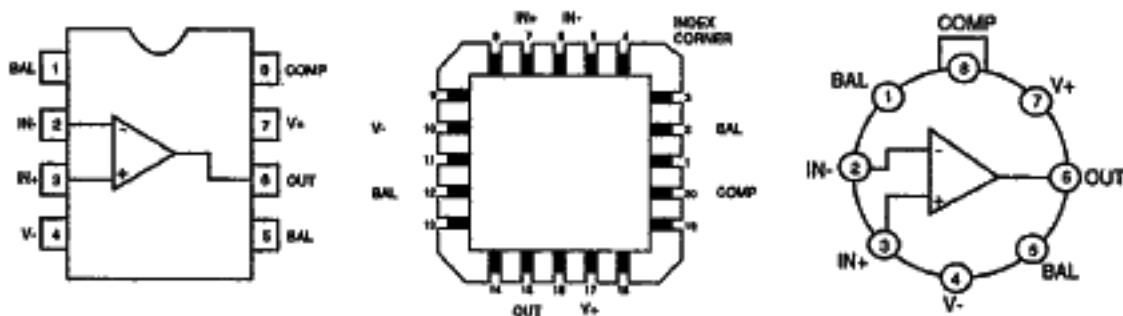

SP-2620/22/25

173-01-10

Very Wideband, Uncompensated Operational Amplifiers

Absolute Maximum Ratings

Voltage Between V ⁺ and V ⁻ Terminals	45.0V	Operating Temperature Range	
Differential Input Voltage, V _d	±12.0V	SP-2620	-55°C ≤ T _A ≤ 125°C
Internal Power Dissipation, P _d	300mW	Storage Temperature Range	-65°C ≤ T _A ≤ 150°C
Peak Output Current	Full Short Circuit Protection		

Electrical Characteristics: V⁺ = +15V, V⁻ = -15V, T_A = 25°C unless otherwise specified in "Conditions".

SP-2620

Parameter	Symbol	Conditions	Min	Typ	Max	Units
Input Characteristics						
Offset Voltage	V _{os}	-55°C ≤ T _A ≤ 125°C		0.5	4	mV
Bias Current	I _b	-55°C ≤ T _A ≤ 125°C		1	15	nA
Offset Current	I _{os}	-55°C ≤ T _A ≤ 125°C		1	15	nA
Input Impedance	Z _{in}	Guaranteed by Design	65	500		MΩ
Common Mode Range	V _{cm}	-55°C ≤ T _A ≤ 125°C	±11.0			V
Transfer Characteristics						
Large Signal Voltage Gain	A _{vCL}	R _L = 2KΩ, V _o = ±10V, C _L = 50pF -55°C ≤ T _A ≤ 125°C, R _L = 2KΩ, C _L = 50pF, V _o = ±10V	100K	150K		V/V
Common Mode Rejection Ratio	CMRR	-55°C ≤ T _A ≤ 125°C, V _{cm} = ±10V	80	100		dB
Gain Bandwidth Product	GBW	V _o < 90mV, R _L = 2KΩ, C _L = 50pF, A _v = 40dB		100		MHz
Output Characteristics						
Output Voltage Swing	V _o	-55°C ≤ T _A ≤ 125°C, R _L = 2KΩ, C _L = 50pF	±10.0	±12.0		V
Output Current	I _{out}	V _o = ±10V	±15	±22		mA
Full Power Bandwidth	FPBW	V _o = ±10V, FPBW = (SR)/(2πV _o), R _L = 2KΩ, C _L = 50pF	400	600		KHz
Transient Response						
Rise Time	t _r	R _L = 2KΩ, C _L = 50pF, V _o = ±200mV, A _v = 40dB		17	45	nS
Slew Rate	SR	R _L = 2KΩ, C _L = 50pF, V _o = ±5V, A _v = 40dB	±25	±35		V/μS
Power Supply						
Supply Current	I _s			3.0	4.0	mA
Power Supply Rejection Ratio	PSRR	-55°C ≤ T _A ≤ 125°C, ΔV _s = ±5V	80	90		dB

SP-2620/22/25

Very Wideband, Uncompensated Operational Amplifiers

T-79-07-10

Absolute Maximum Ratings

Voltage Between V^+ and V^- Terminals	45.0V	Operating Temperature Range	
Differential Input Voltage, V_d	$\pm 12.0V$	SP-2622	$-55^\circ C \leq T_A \leq 125^\circ C$
Internal Power Dissipation, P_d	300mW	Storage Temperature Range	$-65^\circ C \leq T_A \leq 150^\circ C$
Peak Output Current	Full Short Circuit Protection		

Electrical Characteristics: $V^+ = +15V$, $V^- = -15V$, $T_A = 25^\circ C$ unless otherwise specified in "Conditions".

SP-2622

4

Parameter	Symbol	Conditions	Min	Typ	Max	Units
Input Characteristics						
Offset Voltage	V_{os}	$-55^\circ C \leq T_A \leq 125^\circ C$		3	5	mV
Bias Current	I_b	$-55^\circ C \leq T_A \leq 125^\circ C$		5	25	nA
Offset Current	I_{os}	$-55^\circ C \leq T_A \leq 125^\circ C$		5	25	nA
Input Impedance	Z_{in}	Guaranteed by Design	40	300		M Ω
Common Mode Range	V_{cm}	$-55^\circ C \leq T_A \leq 125^\circ C$	± 11.0			V
Transfer Characteristics						
Large Signal Voltage Gain	$A_{v\alpha}$	$R_L = 2K\Omega, V_o = \pm 10V, C_L = 50pF$ $-55^\circ C \leq T_A \leq 125^\circ C, R_L = 2K\Omega, C_L = 50pF, V_o = \pm 10V$	80K 60K	150K		V/V V/V
Common Mode Rejection Ratio	CMRR	$-55^\circ C \leq T_A \leq 125^\circ C, V_{cm} = \pm 10V$	74	100		dB
Gain Bandwidth Product	GBW	$V_o < 90mV, R_L = 2K\Omega, C_L = 50pF, A_v = 40dB$		100		MHz
Output Characteristics						
Output Voltage Swing	V_o	$-55^\circ C \leq T_A \leq 125^\circ C, R_L = 2K\Omega, C_L = 50pF$	± 10.0	± 12.0		V
Output Current	I_{out}	$V_o = \pm 10V$	± 10	± 18		mA
Full Power Bandwidth	FPBW	$V_o = \pm 10V, FPBW = (SR) / (2\pi V_o), R_L = 2K\Omega, C_L = 50pF$	320	600		KHz
Transient Response						
Rise Time	t_r	$R_L = 2K\Omega, C_L = 50pF, V_o = \pm 200mV, A_v = 40dB$		17	45	nS
Slew Rate	SR	$R_L = 2K\Omega, C_L = 50pF, V_o = \pm 5V, A_v = 40dB$	± 20	± 35		V/ μ S
Power Supply						
Supply Current	I_s			3.0	4.0	mA
Power Supply Rejection Ratio	PSRR	$-55^\circ C \leq T_A \leq 125^\circ C, \Delta V_s = \pm 5V$	74	90		dB

SP-2620/22/25

T-79-07-10

Very Wideband, Uncompensated Operational Amplifiers

Absolute Maximum Ratings

Voltage Between V ⁺ and V ⁻ Terminals	45.0V	Operating Temperature Range	
Differential Input Voltage, V _d	±12.0V	SP-2625	0 °C ≤ T _A ≤ 75 °C
Internal Power Dissipation, P _d	300mW	Storage Temperature Range	-65 °C ≤ T _A ≤ 150 °C
Peak Output Current	Full Short Circuit Protection		

Electrical Characteristics: V⁺ = +15V, V⁻ = -15V, T_A = 25 °C unless otherwise specified in "Conditions".

SP-2625

Parameter	Symbol	Conditions	Min	Typ	Max	Units
Input Characteristics						
Offset Voltage	V _{os}	0 °C ≤ T _A ≤ 75 °C		3	5 7	mV mV
Bias Current	I _b	0 °C ≤ T _A ≤ 75 °C		5	25 40	nA nA
Offset Current	I _{os}	0 °C ≤ T _A ≤ 75 °C		5	25 40	nA nA
Input Impedance	Z _{in}	Guaranteed by Design	40	300		MΩ
Common Mode Range	V _{cm}	0 °C ≤ T _A ≤ 75 °C	±11.0			V
Transfer Characteristics						
Large Signal Voltage Gain	A _{v(OL)}	R _L = 2KΩ, V _o = ±10V, C _L = 50pF 0 °C ≤ T _A ≤ 75 °C, R _L = 2KΩ, V _o = ±10V, C _L = 50pF	80K 70K	150K		V/V V/V
Common Mode Rejection Ratio	CMRR	0 °C ≤ T _A ≤ 75 °C, V _{cm} = ±10V	74	100		dB
Gain Bandwidth Product	GBW	V _o < 90mV, C _L = 50pF, R _L = 2KΩ, A _v = 40dB		100		MHz
Output Characteristics						
Output Voltage Swing	V _o	0 °C ≤ T _A ≤ 75 °C, R _L = 2KΩ, C _L = 50pF	±10.0	±12.0		V
Output Current	I _{out}	V _o = ±10V	±10	±18		mA
Full Power Bandwidth	FPBW	V _o = ±10V, FPBW = (SR)(2πV _o) ⁻¹ , C _L = 50pF, R _L = 2KΩ	320	600		KHz
Transient Response						
Rise Time	t _r	R _L = 2KΩ, C _L = 50pF, A _v = 5		17	45	nS
Slew Rate	SR	R _L = 2KΩ, C _L = 50pF, V _o = ±5V, A _v = 5	±20	±35		V/μS
Power Supply						
Supply Current	I _b			3.0	4.0	mA
Power Supply Rejection Ratio	PSRR	0 °C ≤ T _A ≤ 75 °C, ΔV _s = ±5V	74	90		dB

SP-2620/22/25

Very Wideband Uncompensated Operational Amplifiers

T-79-07-10

A.C. Performance

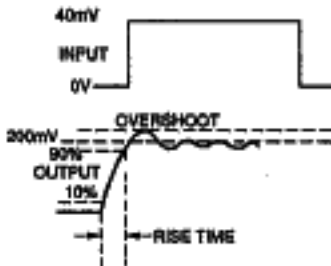

Transient Response

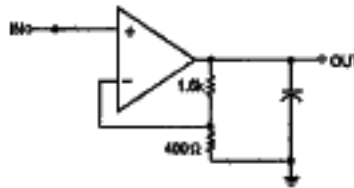

A.C. Test Circuit

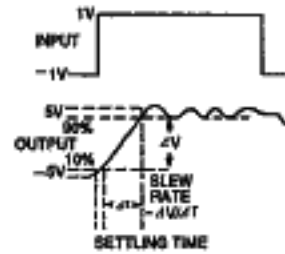

Slow Rate/Settling Time

4

Ordering Information

When ordering the SP-2620/22/25, specify the package and screening according to the following :

Prefix:	SP (SIPEX)	SP 2 - 2620 - 2	Generic Part #
PACKAGE :			SCREENING
1 - 14 pin ceramic DIP		-2 :	-55 °C to 125 °C
2 - Metal Can		-4 :	-25 °C to 85 °C
3 - 8 Pin Plastic DIP		-5 :	0 °C to 75 °C
4 - 20 Pin LCC		-6 :	25 °C 100% D.C. Probe (Dice Only)
7 - 8-Pin Cerdip		/883 :	-55 °C to 125 °C Full Mil Processing
0 - DICE			

NOTES: 1. Not all package types and screening option combinations are available. Consult local sales office or factory for availability information.

2. Consult factory for special package or screening requirements.

3. Consult factory for 883 revision C compliant data sheet.

4. Consult factory for package mechanical dimensions.

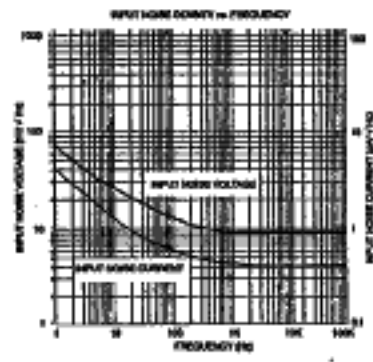
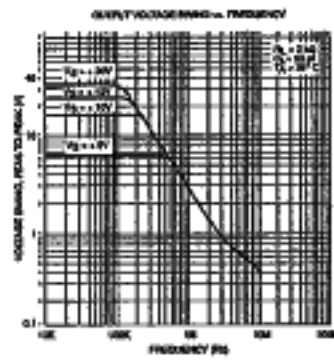
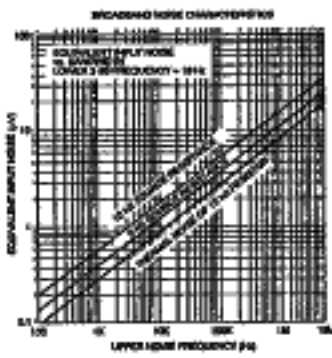

T-79-07-10

