

SMDS-50H

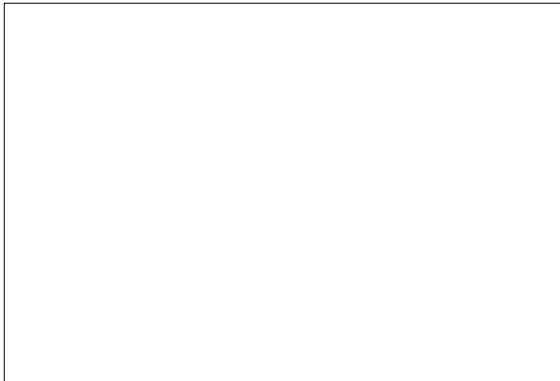

Three Phase Rectifier Module



Type	V_{RSM}	V_{RRM}
SMDS-50H-06	800	600
SMDS-50H-08	1000	800
SMDS-50H-12	1400	1200
SMDS-50H-14	1600	1400
SMDS-50H-16	1800	1600
SMDS-50H-18	2000	1800
SMDS-50H-20	2200	2000

Type	I_{DAV}	T_c	I_{FSM}	i^2t	V_{TM}	I_{FM}	V_{TO}	r_T	T_{VJ}	V_{isol}	R_{thJC}
	A	$^{\circ}C$	KA	KA^2s	V	A	V	$m\Omega$	$^{\circ}C$	V	K/W
SMDS-50H	50	100	0.75	2.8	1.55	50	0.8	8	150	2500	0.55

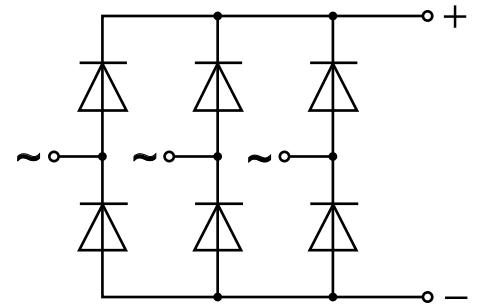
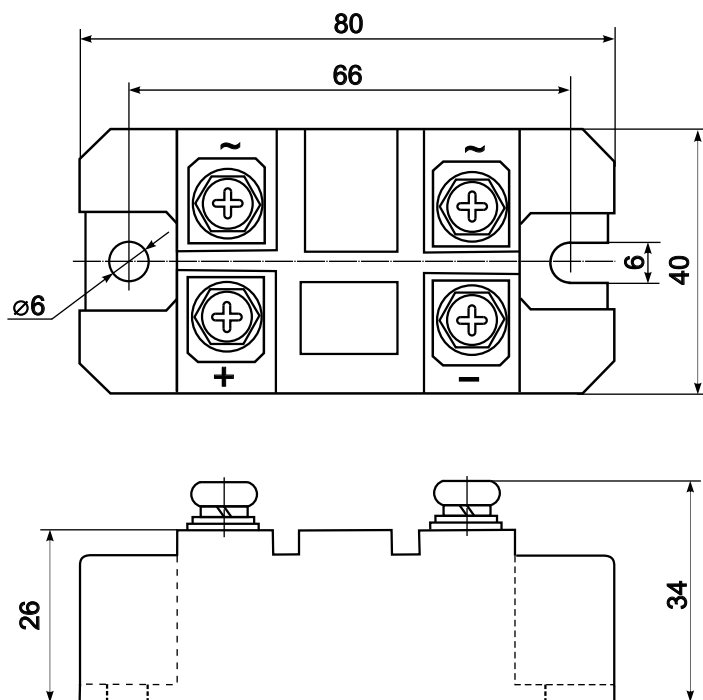

Features:

- Industrial standard package
- Heat transfer through aluminium nitride ceramic isolated metal baseplate
- Precise internal pressure contacts for high reliability
- 2500V RMS isolation voltage

Typical Applications:

- DC power supply for instrument and equipment
- Power converters
- Electronic welders
- Lighting control