

# General Purpose Power Wirewound Resistors

## PW Series

- 2 watts to 25 watts
- 0.10 ohms to 30K ohms
- $\pm 10\%$  or  $\pm 5\%$  tolerance
- TC's from 300 ppm/ $^{\circ}\text{C}$  to +5500 ppm/ $^{\circ}\text{C}$

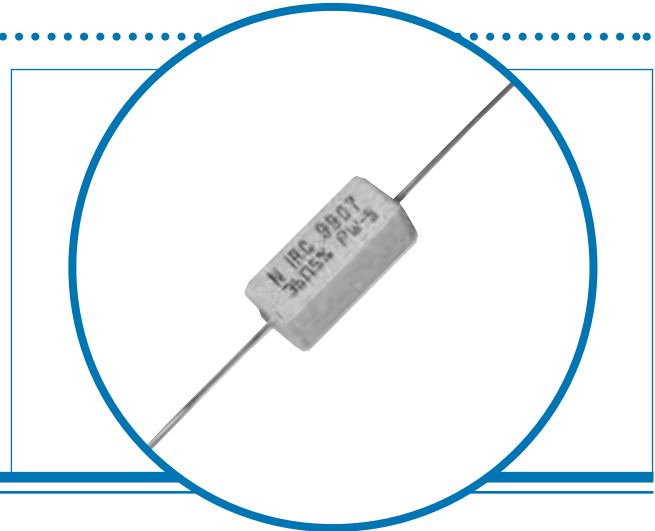

## Electrical Data

		PW-2	PW-3	PW-5	PW-7	PW-10	PW-15	PW-18	PW-22	PW-25
Power rating at 25 $^{\circ}\text{C}$	watts	2	3	5	7	10	15	18	22	25
Resistance range	ohms	0R15 to 2K4	0R1 to 7K5	0R1 to 8K5	0R1 to 18K	0R18 to 30K	0R18 to 30K	0R18 to 22K	0R27 to 18K	0R27 to 18K
Temperature coefficient	0.06%/ $^{\circ}\text{C}$	0.15 to 0.99	0.1 to 0.99	0.1 to 0.99	0.1 to 0.99	0.18 to 0.99	0.18 to 0.99	0.18 to 0.99	0.27 to 1.3	0.27 to 1.3
over R range	0.03%/ $^{\circ}\text{C}$	1.0 to 2.4K	1.0 to 7.5K	1.0 to 8.5K	1.0 to 18K	1.0 to 30K	1.0 to 30K	1.0 to 22K	1.5 to 12K	1.5 to 10K
	+0.55%/ $^{\circ}\text{C}$	0.1 to 30	0.1 to 86	0.1 to 68	0.1 to 150	0.1 to 240	0.1 to 240	0.1 to 200	0.15 to 360	0.15 to 300
	+0.45%/ $^{\circ}\text{C}$	0.24 to 130	0.1 to 270	0.1 to 300	0.15 to 680	0.24 to 1100	0.24 to 1100	0.24 to 1100	0.36 to 1800	0.36 to 1200
	+0.25%/ $^{\circ}\text{C}$	1.0 to 10	0.24 to 20	0.27 to 22	1.0 to 51	1.0 to 82	1.0 to 82	1.0 to 70	1.0 to 120	1.5 to 100

Please note: When ordering the alternative configuration please add an 'A' after the part number. (i.e., PW-2A)

## Physical Data

Dimensions (mm)							
	L $\pm 0.8$	W $\pm 0.8$	H $\pm 0.8$	d dia.	E $\pm 0.8$	LL min.	F (ref.)
PW-2	17.5	6.35	6.35	0.8	7.87	36.6	1.60
PW-3	22.4	7.87	7.87	0.91	9.65	36.6	1.60
PW-5	22.4	9.65	8.64	0.91	10.4	38.1	1.60
PW-7	35.3	9.65	8.64	0.91	11.9	38.1	3.18
PW-10	47.8	9.65	8.64	0.91	11.9	38.1	3.18
PW-15	47.8	12.7	12.7	0.91	16.0	38.1	3.18
PW-18	47.8	12.7	12.7	0.91	16.0	38.1	3.18
PW-22	63.5	12.7	12.7	1.0*	16.0	38.1	3.18
PW-25	63.5	12.7	12.7	1.0*	16.0	38.1	3.18

\* Copper Clad Steel

### Standard Configuration

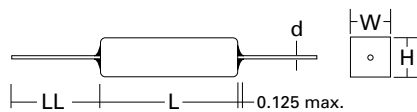

### Alternate Configuration

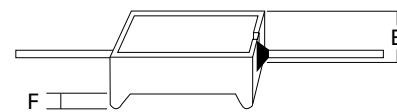

### General Note

Welwyn Components reserves the right to make changes in product specification without notice or liability. All information is subject to Welwyn's own data and is considered accurate at time of going to print.

© Welwyn Components Limited · Bedlington, Northumberland NE22 7AA, UK  
 Telephone: +44 (0) 1670 822181 · Facsimile: +44 (0) 1670 829465 · Email: info@welwyn-tt.com · Website: www.welwyn-tt.com

# General Purpose Power Wirewound Resistors

PW Series

## Power Derating

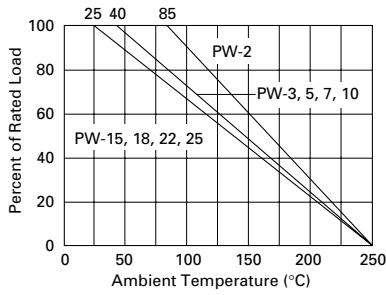

## Temperature Rise

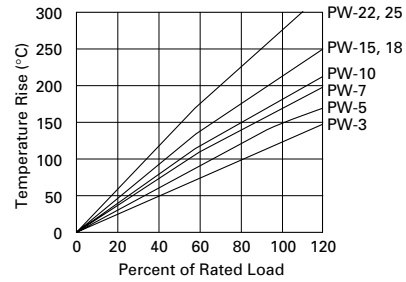

## Packaging

Resistors are supplied bulk packed. Quantity 500.

# General Purpose Power Wirewound Resistors

## PW Series

- 20 watts to 50 watts
- 0.10 ohms to 2.0K ohms
- $\pm 10\%$  or  $\pm 5\%$  tolerance
- Customs

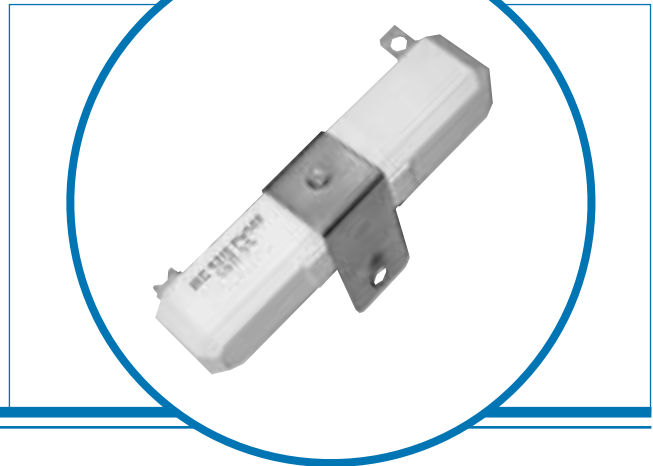

## Electrical Data

		PW-20E	PW-30	PW-40	PW-50E
Power rating at 25°C	watts	20	30	40	50
Resistance range	ohms	0R1 to 2K	0R5 to 1K2	0R65 to 1K5	0R08 to 1K8

Please note: When ordering the alternative configuration please add an 'A' after the part number. (i.e., PW-2A)

Dimensions (Inches)		
	A $\pm 0.030$	B $\pm 0.060$
PW-20E	1.875	2.50
PW-30	2.00	2.55
PW-40	2.45	3.00
PW-50E	3.075	3.625

### PW-20E Wirewound

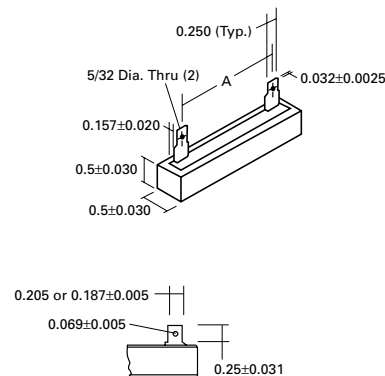

PW-20E Alternate Terminal Configuration

### PW-30, 40 and 50E Wirewound

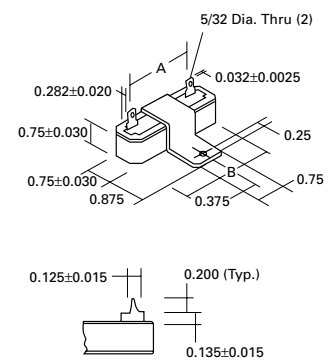

Printed Circuit Terminal

## Power Derating

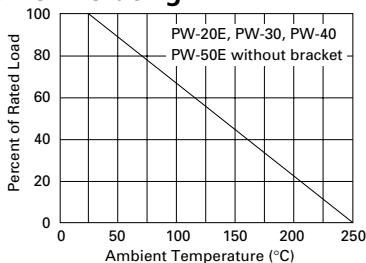

## With Bracket:

PW-30 Increased to 40 watts  
 PW-40 Increased to 50 watts  
 PW-50 Increased to 60 watts

## Temperature Rise

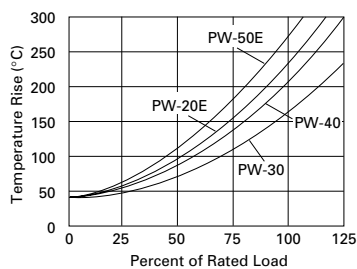

### PW-15E

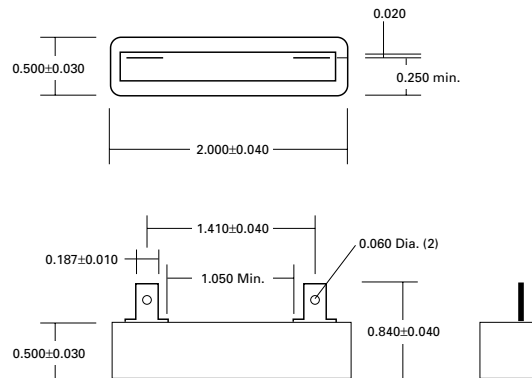

## General Note

Welwyn Components reserves the right to make changes in product specification without notice or liability. All information is subject to Welwyn's own data and is considered accurate at time of going to print.

# General Purpose Power Wirewound Resistors

PW Series

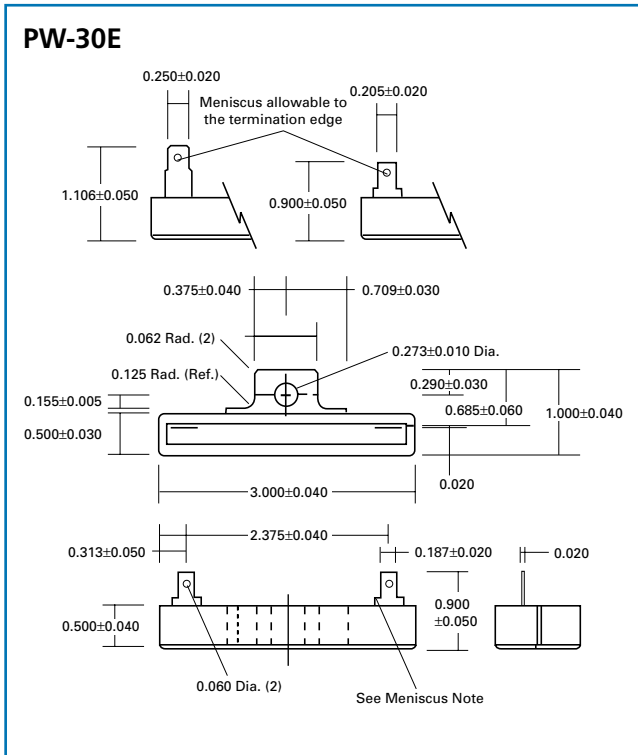

## Packaging

Resistors are supplied bulk packed. Quantity 500.