

Low Resistance Resettable Fuse PTC SMD1210 Series

Features

RoHS Compliant & Halogen Free

faster tripping, 1210 Dimension, Surface mountable, Solid state

Operation Current: 1.5A~7.5A

Maximum Voltage: 6V / 12Vdc

Operating Temperature: -40°C to +85°C

Agency recognition:  RoHS



Dimensions(3225mm/ 1210 mils) Unit: mm

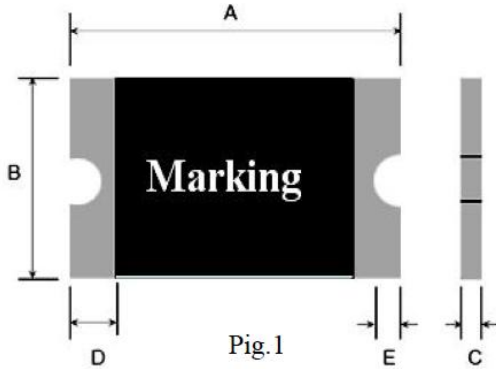

Terminal pad materials :Tin-Plated Nickle-copper
Terminal pad solderability : Meets EIA specification
RS 186-9E and ANSI/J-STD-002 Category 3.

Part number	Marking	A		B		C		D	E	Certification		Delivery Time	
		Min	max	Min	Max	Min	Max	Min	Min	UL	TUV	in stock	Produce
JK-SMD1210-150L	JC	3.0	3.43	2.35	2.8	0.3	0.7	0.25	0.1	-	-	3days	18days
JK-SMD1210-150L-12	JC	3.0	3.43	2.35	2.8	0.3	0.7	0.25	0.1	-	-	3days	18days
JK-SMD1210-175L	JC	3.0	3.43	2.35	2.8	0.3	0.7	0.25	0.1	-	-	3days	18days
JK-SMD1210-175L-12	JC	3.0	3.43	2.35	2.8	0.3	0.7	0.25	0.1	-	-	3days	18days
JK-SMD1210-190L	JD	3.0	3.43	2.35	2.8	0.3	0.7	0.25	0.1	-	-	3days	18days
JK-SMD1210-190L-12	JD	3.0	3.43	2.35	2.8	0.3	0.7	0.25	0.1	-	-	3days	18days
JK-SMD1210-200L	JD	3.0	3.43	2.35	2.8	0.3	0.7	0.25	0.1	-	-	3days	18days
JK-SMD1210-200L-12	JD	3.0	3.43	2.35	2.8	0.3	0.7	0.25	0.1	-	-	3days	18days
JK-SMD1210-260L	JL	3.0	3.43	2.35	2.8	0.4	1.0	0.25	0.1	-	-	3days	18days
JK-SMD1210-260L-12	JL	3.0	3.43	2.35	2.8	0.4	1.0	0.25	0.1	-	-	3days	18days
JK-SMD1210-300L	JL	3.0	3.43	2.35	2.8	0.4	1.0	0.25	0.1	-	-	3days	18days
JK-SMD1210-300L-12	JL	3.0	3.43	2.35	2.8	0.4	1.0	0.25	0.1	-	-	3days	18days
JK-SMD1210-350L	JO	3.0	3.43	2.35	2.8	0.4	1.2	0.25	0.1	-	-	3days	18days
JK-SMD1210-350L-12	JO	3.0	3.43	2.35	2.8	0.4	1.2	0.25	0.1	-	-	3days	18days

Specifications are subject to change without notice

Tel: +86-755-27465585

Dimensions(3225mm/ 1210 mils) Unit: mm



Part number	Marking	A		B		C		D	E	Certification		Delivery Time	
		Min	max	Min	Max	Min	Max	Min	Min	UL	TUV	in stock	Produce
JK-SMD1210-380L	JO	3.0	3.43	2.35	2.8	0.4	1.2	0.25	0.1	-	-	3days	18days
JK-SMD1210-380L-12	JO	3.0	3.43	2.35	2.8	0.4	1.2	0.25	0.1	-	-	3days	18days
JK-SMD1210-400L	JR	3.0	3.43	2.35	2.8	0.5	1.2	0.25	0.1	-	-	3days	18days
JK-SMD1210-400L-12	JR	3.0	3.43	2.35	2.8	0.5	1.2	0.25	0.1	-	-	3days	18days
JK-SMD1210-450L	JR	3.0	3.43	2.35	2.8	0.5	1.4	0.25	0.1	-	-	3days	18days
JK-SMD1210-450L-12	JR	3.0	3.43	2.35	2.8	0.5	1.4	0.25	0.1	-	-	3days	18days
JK-SMD1210-500L	JP	3.0	3.43	2.35	2.8	0.5	1.4	0.25	0.1	-	-	3days	18days
JK-SMD1210-500L-12	JP	3.0	3.43	2.35	2.8	0.5	1.4	0.25	0.1	-	-	3days	18days
JK-SMD1210-550L	JP	3.0	3.43	2.35	2.8	0.5	1.4	0.25	0.1	-	-	3days	18days
JK-SMD1210-550L-12	JP	3.0	3.43	2.35	2.8	0.5	1.4	0.25	0.1	-	-	3days	18days
JK-SMD1210-600L	JT	3.0	3.43	2.35	2.8	0.5	1.6	0.25	0.1	-	-	3days	18days
JK-SMD1210-600L-12	JT	3.0	3.43	2.35	2.8	0.5	1.6	0.25	0.1	-	-	3days	18days
JK-SMD1210-650L	JT	3.0	3.43	2.35	2.8	0.5	1.6	0.25	0.1	-	-	3days	18days
JK-SMD1210-650L-12	JT	3.0	3.43	2.35	2.8	0.5	1.6	0.25	0.1	-	-	3days	18days
JK-SMD1210-700L	JX	3.0	3.43	2.35	2.8	0.5	1.6	0.25	0.1	-	-	3days	18days
JK-SMD1210-700L-12	JX	3.0	3.43	2.35	2.8	0.5	1.6	0.25	0.1	-	-	3days	18days
JK-SMD1210-750L	JX	3.0	3.43	2.35	2.8	0.5	1.6	0.25	0.1	-	-	3days	18days
JK-SMD1210-750L-12	JX	3.0	3.43	2.35	2.8	0.5	1.6	0.25	0.1	-	-	3days	18days

Electrical characteristics(25°C)

Part Number	I _{Hold}	I _{Trip}	V _{max}	I _{max}	P _d	Maximum Time to Trip		Resistance (Ω)		Certification		Delivery Time	
	A	A	DC	A	W	Current (A)	Time (S)	R _{imin}	R _{1max}	UL	TUV	in stock	Produce
	JK-SMD1210-150L	1.5	3.0	6V	50	0.8	8.0	2.0	0.01	0.06	-	-	3days
JK-SMD1210-150L-12	1.5	3.0	12V	50	0.8	8.0	2.0	0.01	0.06	-	-	3days	18days
JK-SMD1210-175L	1.75	3.5	6V	50	0.8	8.0	2.0	0.005	0.04	-	-	3days	18days
JK-SMD1210-175L-12	1.75	3.5	12V	50	0.8	8.0	2.0	0.005	0.04	-	-	3days	18days
JK-SMD1210-190L	1.9	3.8	6V	50	0.8	8.0	3.0	0.006	0.037	-	-	3days	18days
JK-SMD1210-190L-12	1.9	3.8	12V	50	0.8	8.0	3.0	0.006	0.037	-	-	3days	18days
JK-SMD1210-200L	2.0	4.0	6V	50	0.8	8.0	3.0	0.006	0.035	-	-	3days	18days
JK-SMD1210-200L-12	2.0	4.0	12V	50	0.8	8.0	3.0	0.006	0.035	-	-	3days	18days

Electrical characteristics(25°C)



Part Number	I _{Hold}	I _{Trip}	V _{max}	I _{max}	P _d Max	Maximum Time to Trip		Resistance (Ω)		Certification		Delivery Time	
	A	A	DC	A	W	Current (A)	Time (S)	R _{imin}	R _{1max}	UL	TUV	in stock	Produce
JK-SMD1210-260L	2.6	5.2	6V	50	0.8	13.0	2.0	0.003	0.025	-	-	3days	18days
JK-SMD1210-260L-12	2.6	5.2	12V	50	0.8	13.0	2.0	0.003	0.025	-	-	3days	18days
JK-SMD1210-300L	3.0	6.0	6V	50	0.8	15.0	2.0	0.003	0.02	-	-	3days	18days
JK-SMD1210-300L-12	3.0	6.0	12V	50	0.8	15.0	2.0	0.003	0.02	-	-	3days	18days
JK-SMD1210-350L	3.5	7.0	6V	50	0.8	17.5	2.0	0.002	0.018	-	-	3days	18days
JK-SMD1210-350L-12	3.5	7.0	12V	50	0.8	17.5	2.0	0.002	0.018	-	-	3days	18days
JK-SMD1210-380L	3.8	7.6	6V	50	0.8	19.0	2.0	0.002	0.016	-	-	3days	18days
JK-SMD1210-380L-12	3.8	7.6	12V	50	0.8	19.0	2.0	0.002	0.016	-	-	3days	18days
JK-SMD1210-400L	4.0	8.0	6V	50	0.8	20.0	2.0	0.002	0.014	-	-	3days	18days
JK-SMD1210-400L-12	4.0	8.0	12V	50	0.8	20.0	2.0	0.002	0.014	-	-	3days	18days
JK-SMD1210-450L	4.5	9.0	6V	50	1.0	22.5	2.0	0.001	0.013	-	-	3days	18days
JK-SMD1210-450L-12	4.5	9.0	12V	50	1.0	22.5	2.0	0.001	0.013	-	-	3days	18days
JK-SMD1210-500L	5.0	10	6V	50	1.0	25.0	2.0	0.001	0.012	-	-	3days	18days
JK-SMD1210-500L-12	5.0	10	12V	50	1.0	25.0	2.0	0.001	0.012	-	-	3days	18days
JK-SMD1210-550L	5.5	11	6V	50	1.0	27.5	2.0	0.001	0.011	-	-	3days	18days
JK-SMD1210-550L-12	5.5	11	12V	50	1.0	27.5	2.0	0.001	0.011	-	-	3days	18days
JK-SMD1210-600L	6.0	12	6V	50	1.2	30.0	2.0	0.001	0.010	-	-	3days	18days
JK-SMD1210-600L-12	6.0	12	12V	50	1.2	30.0	2.0	0.001	0.010	-	-	3days	18days
JK-SMD1210-650L	6.5	13	6V	50	1.2	32.5	2.0	0.001	0.009	-	-	3days	18days
JK-SMD1210-650L-12	6.5	13	12V	50	1.2	32.5	2.0	0.001	0.009	-	-	3days	18days
JK-SMD1210-700L	7.0	14	6V	50	1.2	35.0	2.0	0.001	0.008	-	-	3days	18days
JK-SMD1210-700L-12	7.0	14	12V	50	1.2	35.0	2.0	0.001	0.008	-	-	3days	18days
JK-SMD1210-750L	7.5	15	6V	50	1.2	37.5	2.0	0.001	0.007	-	-	3days	18days
JK-SMD1210-750L-12	7.5	15	12V	50	1.2	37.5	2.0	0.001	0.007	-	-	3days	18days

I_{hold} = Hold Current. Maximum current device will not trip in 25°C still air.

I_{trip} = Trip Current. Minimum current at which the device will always trip in 25°C still air.

V_{max} = Maximum operating voltage device can withstand without damage at rated current (I_{max}).

I_{max} = Maximum fault current device can withstand without damage at rated voltage (V_{max}).

P_d = Maximum power dissipation when device is in the tripped state in 25°C still air environment at rated voltage.

R_{imin/max} = Minimum/Maximum device resistance prior to tripping at 25°C.

R_{1max} = Maximum device resistance is measured one hour post reflow.

Specifications are subject to change without notice

Thermal Derating Chart-IH(A)



Maximum ambient operating temperatures °C

Part Number	-40°C	-20°C	0°C	25°C	40°C	50°C	60°C	70°C	85°C
JK-SMD1210-150L	2.25	2.00	1.75	1.5A	1.33	1.15	1.05	0.93	0.70
JK-SMD1210-150L-12	2.25	2.00	1.75	1.5A	1.33	1.15	1.05	0.93	0.70
JK-SMD1210-175L	2.55	2.33	2.02	1.75A	1.53	1.35	1.23	1.07	0.85
JK-SMD1210-175L-12	2.55	2.33	2.02	1.75A	1.53	1.35	1.23	1.07	0.85
JK-SMD1210-190L	2.81	2.53	2.20	1.9A	1.67	1.47	1.34	1.17	0.91
JK-SMD1210-190L-12	2.81	2.53	2.20	1.9A	1.67	1.47	1.34	1.17	0.91
JK-SMD1210-200L	2.96	2.67	2.32	2.0A	1.76	1.55	1.41	1.23	0.96
JK-SMD1210-200L-12	2.96	2.67	2.32	2.0A	1.76	1.55	1.41	1.23	0.96
JK-SMD1210-260L	3.85	3.47	3.02	2.6A	2.29	2.01	1.84	1.59	1.25
JK-SMD1210-260L-12	3.85	3.47	3.02	2.6A	2.29	2.01	1.84	1.59	1.25
JK-SMD1210-300L	4.40	3.98	3.45	3.0A	2.64	2.30	2.15	1.83	1.42
JK-SMD1210-300L-12	4.40	3.98	3.45	3.0A	2.64	2.30	2.15	1.83	1.42
JK-SMD1210-350L	5.18	4.67	4.06	3.5A	3.08	2.71	2.47	2.15	1.68
JK-SMD1210-350L-12	5.18	4.67	4.06	3.5A	3.08	2.71	2.47	2.15	1.68
JK-SMD1210-380L	5.55	5.02	4.35	3.8A	3.32	2.92	2.65	2.30	1.81
JK-SMD1210-380L-12	5.55	5.02	4.35	3.8A	3.32	2.92	2.65	2.30	1.81
JK-SMD1210-400L	5.92	5.33	4.64	4.0A	3.52	3.09	2.83	2.45	1.92
JK-SMD1210-400L-12	5.92	5.33	4.64	4.0A	3.52	3.09	2.83	2.45	1.92
JK-SMD1210-450L	6.12	5.39	5.16	4.5A	3.85	3.35	3.00	2.36	1.56
JK-SMD1210-450L-12	6.12	5.39	5.16	4.5A	3.85	3.35	3.00	2.36	1.56
JK-SMD1210-500L	7.40	6.67	5.80	5.0A	4.40	3.87	3.53	3.07	2.40
JK-SMD1210-500L-12	7.40	6.67	5.80	5.0A	4.40	3.87	3.53	3.07	2.40
JK-SMD1210-550L	8.14	7.34	6.38	5.5A	4.84	4.26	3.88	3.38	2.64
JK-SMD1210-550L-12	8.14	7.34	6.38	5.5A	4.84	4.26	3.88	3.38	2.64
JK-SMD1210-600L	8.65	7.91	6.93	6.0A	5.23	4.45	4.00	3.63	2.85
JK-SMD1210-600L-12	8.65	7.91	6.93	6.0A	5.23	4.45	4.00	3.63	2.85
JK-SMD1210-650L	9.20	8.45	7.45	6.5A	5.60	4.65	4.30	3.89	3.00
JK-SMD1210-650L-12	9.20	8.45	7.45	6.5A	5.60	4.65	4.30	3.89	3.00
JK-SMD1210-700L	9.84	9.00	7.95	7.0A	5.96	4.95	4.50	4.16	3.20
JK-SMD1210-700L-12	9.84	9.00	7.95	7.0A	5.96	4.95	4.50	4.16	3.20
JK-SMD1210-750L	10.5	9.65	8.50	7.5A	6.40	5.30	4.80	4.45	4.42
JK-SMD1210-750L-12	10.5	9.65	8.50	7.5A	6.40	5.30	4.80	4.45	4.42

Part number System



JK- SMD 1210 - xxx L- 12

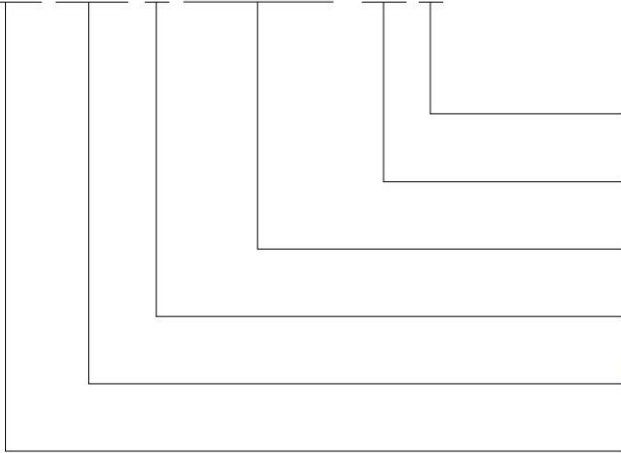

- 12V Products
- Low Resistance
- Holding Current Rating
- 1210 Dimension
- Surface Mount Device
- Our Mark

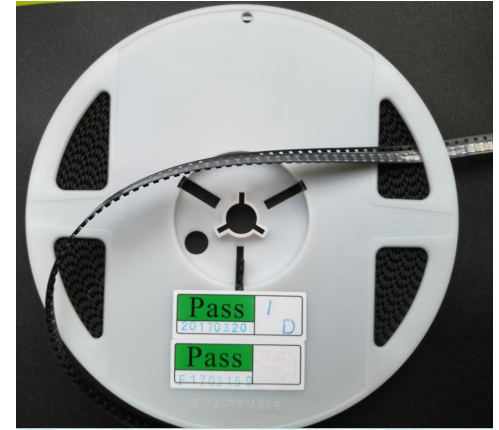

Test Procedures and Requirements

Test Item	Test Conditions	Accept/Reject Criteria
Initial Resistance	In still air @ 25°C	$R_{min} \leq R \leq R_{max}$
Time to Trip	Specified current, V_{max} , 25°C	$T \leq$ maximum Time to Trip
Hold Current	30min ,at I_H , 25°C	No trip
Trip Cycle Life	V_{max} , I_{max} , 100cycles	No arcing or burning
Trip Endurance	V_{max} , I_{max} , 1hours	No arcing or burning

Physical Characteristics

Terminal materials :	Tin-Plated Nickle-copper
Soldering zone	Meets EIA specification RS 186-9E and ANSI/J-STD-002 Category 3.
Moisture Sensitivity	Level 2a, per IPC/JEDEC J-STD 020C

Environmental Specifications

Test Item	Test Conditions	Resistance change
Passive aging	+85°C, 1000hours	±10% typical
Humidity aging	+85°C/85%R.H.1000hours	±5% typical
Thermal shock	MIL-STD-202,Method 107G ,+85°C/-40°C,20times	-30% typical resistance change
Solvent Resistance	MIL-STD-202,Method 215	No change
Vibration	ML-STD-883C,Test Condition A	No change

Recommended Pad layout(mm)

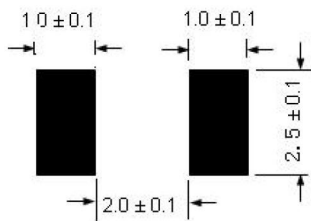

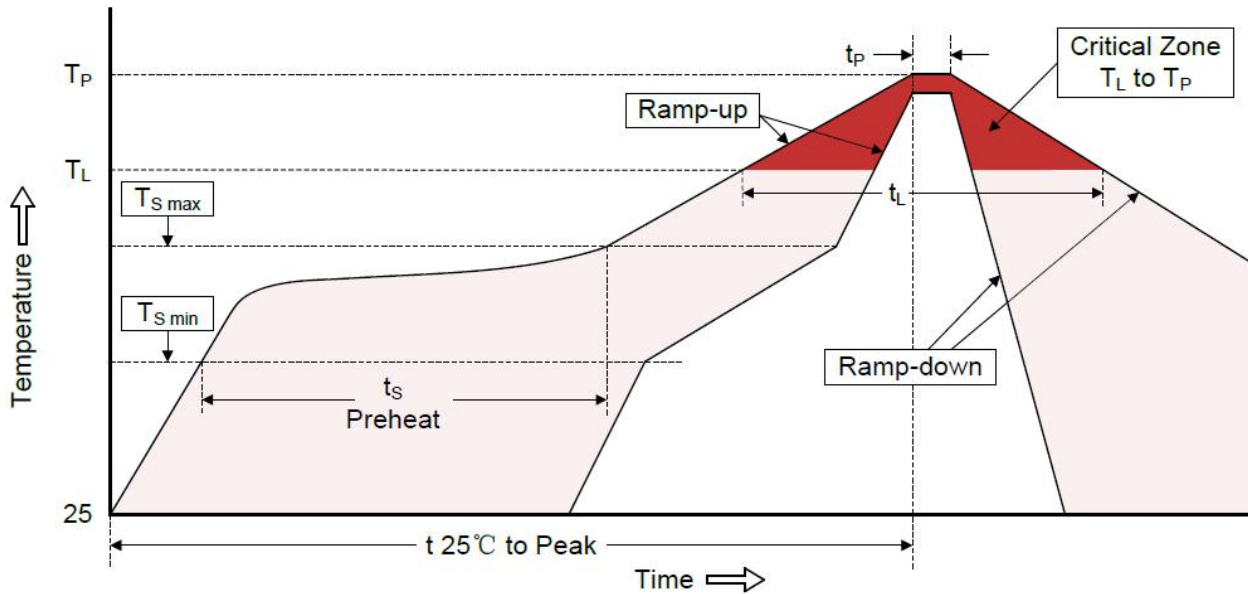

Profile Feature	Pb-Free Assembly
Average ramp-up rate (TS max to TP)	3°C/second max.
Preheat	
-Temperature Min (TS min)	150°C
-Temperature Max (TS max)	200°C
-Time (min to max) (TS min to TS max)	60-180 seconds
Time maintained above:	
-Temperature (TL)	217°C
-Time (tL)	60-150 seconds
Peak Temperature (TP)	260°C
Time within 5°C of actual Peak Temperature (tP)	20-40 seconds
Ramp-down Rate	3°C/second max.
Time 25°C to Peak Temperature	8 minutes max.
Storage Condition	0°C~35°C, ≤70%RH

- Recommended reflow methods: IR, vapor phase oven, hot air oven, N2 environment for lead-free.
- Devices are not designed to be wave soldered to the bottom side of the board.
- Recommended maximum paste thickness is 0.25mm (0.010inch).
- Devices can be cleaned using standard industry methods and solvents.

Note 1: All temperature refer to topside of the package, measured on the package body surface.

Note 2: If reflow temperature exceed the recommended profile, devices may not meet the performance requirements.

Tape Specification and Reel Dimensions



Tape

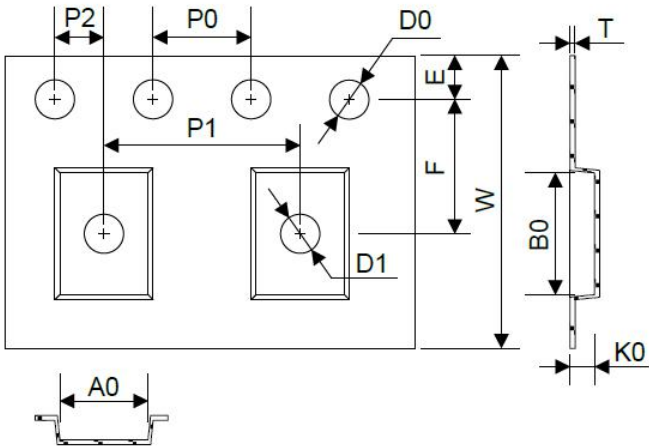

Symbol	Dimensions(mm)
--------	----------------

W	8.00±0.30
F	3.50±0.05
E	1.75±0.10
D0	1.55±0.05
D1	1.00(MIN)
P0	4.00±0.10
P1	4.00±0.10
P2	2.00±0.05
A0	2.82±0.10
B0	3.46±0.10
T	0.25±0.10
K0	1.0/1.3/1.8±0.10
Leader min	390
Trailer min	160
C	Φ178±1.0
D	Φ60.2±0.5
H	11.0±0.5
W	9.0±1.5

Reel

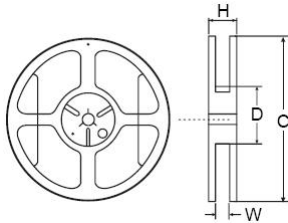

Packaging Quantity

Part Number	Quantity	Part Number	Quantity	Part Number	Quantity
JK-SMD1210-150L	4000PCS	JK-SMD1210-350L	4000PCS	JK-SMD1210-600L	3000PCS
JK-SMD1210-150L-12	4000PCS	JK-SMD1210-350L-12	4000PCS	JK-SMD1210-600L-12	3000PCS
JK-SMD1210-175L	4000PCS	JK-SMD1210-380L	4000PCS	JK-SMD1210-650L	3000PCS
JK-SMD1210-175L-12	4000PCS	JK-SMD1210-380L-12	4000PCS	JK-SMD1210-650L-12	3000PCS
JK-SMD1210-190L	4000PCS	JK-SMD1210-400L	4000PCS	JK-SMD1210-700L	3000PCS
JK-SMD1210-190L-12	4000PCS	JK-SMD1210-400L-12	4000PCS	JK-SMD1210-700L-12	3000PCS
JK-SMD1210-200L	4000PCS	JK-SMD1210-450L	4000PCS	JK-SMD1210-750L	3000PCS
JK-SMD1210-200L-12	4000PCS	JK-SMD1210-450L-12	4000PCS	JK-SMD1210-750L-12	3000PCS
JK-SMD1210-260L	4000PCS	JK-SMD1210-500L	3000PCS	----	----
JK-SMD1210-260L-12	4000PCS	JK-SMD1210-500L-12	3000PCS	----	----
JK-SMD1210-300L	4000PCS	JK-SMD1210-550L	3000PCS	----	----
JK-SMD1210-300L-12	4000PCS	JK-SMD1210-550L-12	3000PCS	----	----

Low Resistance Resettable Fuse PTC SMD1210 Series**Storage**

The maximum ambient temperature shall not exceed 40°C. Storage temperatures higher than 40°C could result in the deformation of packaging materials. The maximum relative humidity recommended for storage is 70%. High humidity with high temperature can accelerate the oxidation of the solder plating on the termination and reduce the solderability of the components. Sealed plastic bags with desiccant shall be used to reduce the oxidation of the termination and shall only be opened prior to use. The products shall not be stored in areas where harmful gases containing sulfur or chlorine are present.

Warning

- Please read this specification before using the product.
- Use PPTC beyond the maximum ratings or improper use may result in device damage and possible electrical arcing and flame.
- PPTC are intended for protection against occasional over current or over temperature fault conditions and should not be used when repeated fault conditions or prolonged trip events are anticipated.
- Device performance can be impacted negatively if devices are handled in a manner inconsistent with recommended electronic, thermal, and mechanical procedures for electronic components.
- Use PPTC with a large inductance in circuit will generate a circuit voltage ($L di/dt$) above the rated voltage of the PPTC.
- Avoid impact PPTC device its thermal expansion like placed under pressure or installed in limited space.
- Contamination of the PPTC material with certain silicon based oils or some aggressive solvents can adversely impact the performance of the devices. PPTC SMD can be cleaned by standard methods.
- Requests that customers comply with our recommended solder pad layouts and recommended reflow profile. Improper board layouts or reflow profile could negatively impact solderability performance of our devices.

Notes

The specification is intended to present application, product and technical data to assist the user in selecting PPTC circuit production devices. However, users should independently evaluate and test the suitability of each product. HUAAN makes no warranties as to the accuracy or completeness of the information and disclaims any liability resulting from its use. HUAAN's only obligations are those in the HUAAN Standard Terms and Conditions of Sale and in no case will HUAAN be liable for any incidental, indirect, or consequential damages arising from the sale, resale, or misuse of its products. HUAAN reserves the right to change or update, without notice, any information contained in this specification.