

Approval Sheet

for

**Metal Glazed Film Resistors
High Voltage & High Ohmic Type**

HHV series

$\pm 1\%$, $\pm 5\%$

YAGEO CORPORATION

Headquarters: 3F, No.233-1, Pao Chiao Rd., Xindian, Taipei, Taiwan, R.O.C.

Tel: 886-2-6629-9999 **Fax:** 886-2-6628-8885

URL: www.yageo.com

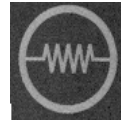

Rev.	Description	Issue Date	Drawn	Approved
00	issue new spec.	Jul 16, 2007	Sara Lin	Joyce Chung
01	Update description Environmental Characteristics revised	Sep 04, 2007	Lynn Chen	Joyce Chung
02	HHV1WS data is included	Jan 09, 2008	Lynn Chen	Joyce Chung
03	The 5th color band is changed to yellow for tolerance 5% to represent high HHV	Jan 16, 2008	Lynn Chen	Joyce Chung
04	Lead Length 26mm is included	Apr 18, 2008	Lynn Chen	Joyce Chung
05	Series adjustment	Aug 29, 2008	Lynn Chen	Joyce Chung
06	HHV1SS data is included	Feb 25, 2009	Lynn Chen	Ken Hsu
07	Revised the product description	Apr 07, 2009	Lynn Chen	Ken Hsu
08	Adjust Index	May 05, 2009	Lynn Chen	Ken Hsu
09	Series adjustment	Sep 02, 2009	Lynn Chen	Ken Hsu
10	Environmental Characteristics revised	Jan 15, 2010	Lynn Chen	Ken Hsu
11	HHV200 is deleted and HHV3SS is included.	Aug 03,2010	Feng Ye	Ken Hsu
12	1) T26 packing method for HHV-50 & HHV1SS series is deleted. 2) HHV100 series is deleted.	Aug 12, 2010	Feng Ye	Ken Hsu
13	The environmental characteristics are adjusted;	Dec 30, 2010	Feng Ye	Ken Hsu
14	Coated with epoxy lacquer type and part number suffix of "Y" are included	Apr 07, 2011	Feng Ye	Ken Hsu
15	Modify tape on box packing data	Jun 27, 2011	Feng Ye	Ken Hsu
16	Revise product description of "the 5 th color band is yellow" to "the last color band is yellow"; Revise band-code cutline.	Feb 03, 2012	Feng Ye	Ken Hsu
17	Added "52-" type taping for HHV2WS&HHV3SS.	May.21, 2014	Feng Ye	Flora Shen
18	Added reel type taping	Nov. 28, 2014	Feng Ye	Flora Shen



Rev.	Description	Issue Date	Drawn	Approved
19	Update reel type dimension A , Add dimension B	Jan 13, 2020	Hui Chen	Feng Ye
20	Forming dimensions are included.	Apr. 09, 2020	Mingfa Liu	Feng Ye

Description	Metal Glazed Film Resistors, High Voltage & High Ohmic Type		
Series	HHV	Rev.	20

1. PRODUCT:

A metal glazed film is deposited on a high grade ceramic body, the resistors are coated with a pink silicone lacquer or a blue epoxy lacquer (on request), the last color band is yellow to represent high voltage resistors.

2. PART NUMBER:

Part number of the high voltage & high ohmic metal glazed film resistor is identified by the name, power, tolerance, packing, temperature coefficient, special type, resistance value and suffix.

Example:

HHV	-50	J	T	-	52-	100K	Y
(1)	(2)	(3)	(4)	(5)	(6)	(7)	(8)
Series Name	Power Rating	Resistance Tolerance	Packing Style	Temperature Coefficient of Resistance	Special Type	Resistance Value	Suffix

(1) Style: HHV SERIES

(2) Power Rating: -25=1/4W 、 50S=1/2W 、 -50=1/2W 、 1SS=1W 、 1WS=1W 、 2SS=2W 、 2WS=2W 、 3SS=3W

(3) Tolerance: F = $\pm 1\%$, J = $\pm 5\%$

(4) Packaging Type: T=Tape on Box Packing
B=Bulk Packing
R=Paper Taping Reel

(5) Temperature Coefficient : “-“=base on spec.

(6) Special Type: 26- = 26mm
52- = 52.4mm
73- = 73mm
M=M-Type Forming for Bulk
MB = MB Type Forming for Bulk
F = F Type Forming for Bulk
FK = FK Type Forming
FFK = FFK Type Forming
FKK = FKK Type Forming
PN=PANAsert (rated watts from 1/4W to 2SS size only)
AV=Avlsert (rated watts from 1/4W to 2SS size only)

(7) Resistance Value: 100K-68M Ω for E24&E96 Series.

(8) Suffix: Y = coated with a blue epoxy lacquer
None = coated with a pink silicone lacquer.

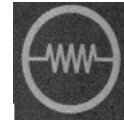

3. BAND-CODE:



COLOR	1st BAND	2nd BAND	3rd BAND	MULTIPLIER	TOLERANCE
BLACK	0	0	0	1Ω	
BROWN	1	1	1	10Ω	± 1 % (F)
RED	2	2	2	100Ω	
ORANGE	3	3	3	1KΩ	
YELLOW	4	4	4	10KΩ	HHV Series
GREEN	5	5	5	100KΩ	
BLUE	6	6	6	1MΩ	
VIOLET	7	7	7	10MΩ	
GREY	8	8	8		
WHITE	9	9	9		
GOLD				0.1Ω	± 5 % (J)
SILVER				0.01Ω	

* TOL: ± 1 % (F)--- 6 color band.

* TOL: ± 5 % (J)--- 5 color band.(3rd BAND is not included)

4. ELECTRICAL CHARACTERISTICS

TABLE I

STYLE	HHV-25	HHV50S	HHV-50	HHV1SS	HHV1WS	HHV2SS	HHV2WS	HHV3SS
Power Rating at 70 °C	1/4W	1/2W		1W		2W		3W
Maximum Working Voltage(DC)	1600V		3500V		5000V		7000V	
Maximum Overload Voltage(DC)	3000V		7000V		10000V		14000V	
Voltage Proof (Silicone Type)	300V		500V		600V			
Voltage Proof (Epoxy Type)	500V				700V			
Resistance Range	100K ~ 68MΩ for E24 & E96 series value							
Operating Temp. Range	- 55 °C to + 155 °C							
Temperature Coefficient	± 200 ppm /°C							

* Below or over this resistance on request

5. DERATING CURVE

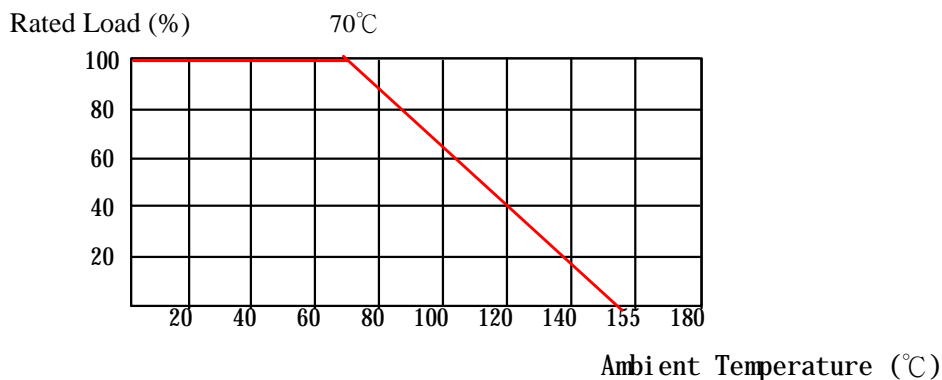

6. DIMENSIONS

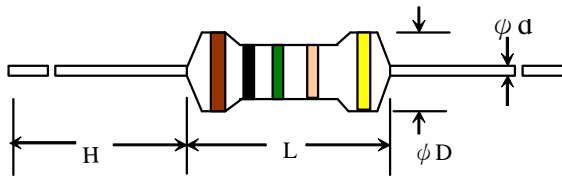

STYLE		DIMENSIONS(unit:mm)			
Normal	Miniature	L	ψD	H	ψd
HHV-25	HHV50S	6.3±0.5	2.4±0.2	28±2.0	0.55±0.05
HHV-50	HHV1SS	9.0±0.5	3.3±0.3	26±2.0	0.55±0.05
HHV1WS	HHV2SS	11.5±1.0	4.5±0.5	35±2.0	0.80±0.05
HHV2WS	HHV3SS	15.5±1.0	5.0±0.5	33±2.0	0.80±0.05

7. ENVIRONMENTAL CHARACTERISTICS

(1) Short Time Over Load Test

At 2.5 times of the rated voltage, or the maximum load voltage, whichever is the less, applied for 5 seconds, the resistor should be free from defects after the resistor is released from load for about 30 minutes

$$\text{Short Time Overload Voltage} = 2.5 * \sqrt{\text{Power Rating} \cdot \text{Resistance Value}}$$

The change of the resistance value should be within ± 2.0 % + 0.05Ω

(2) Voltage Proof

The resistor shall be clamped in the trough of a 90° metal V Block. Apply the insulation voltage specified in the "Table I" between the terminals connected together with the block for about 60 seconds. The resistor shall be able to withstand without breakdown or flashover.

(3) Temperature Coefficient Test

Test of resistors above room temperature 100°C ± 2°C (Testing Temperature 115°C to 130°C) at the constant temperature silicon plate for over 5 minutes. Then measure the resistance value. The Temperature Coefficient is calculated by the following equation and its value should be within the range of requested.

$$\text{Resistor Temperature Coefficient} = \frac{R - R_0}{R_0} \cdot \frac{1}{t - t_0} \cdot 10^6$$

R = Resistance value under the testing temperature

R₀ = Resistance value at the room temperature

t = The testing temperature

t₀ = Room temperature



(4) Insulation Resistance

Apply "measuring voltage" between protective coating and termination for 1 min., then measure. The measuring voltage shall be either 100V±15V d.c. for resistors with an insulation voltage lower than 500V or 500V±50V d.c. for resistors with an insulation voltage equal to or greater than 500V. The test resistance should be high than 10,000M ohm.

(5) Solderability

Immerse the specimen into the solder pot at 245 ± 5 °C for 3 ± 0.5 seconds. At least 95% solder coverage on the termination.

(6) Solvent Resistance of Marking

The specimen into the appropriate solvent of IPA condition of ultrasonic machine for 5± 0.5 minutes. The specimen is no deterioration of coatings and color code

(7) Robustness of Terminations

Direct Load – Resistors shall be held by one terminal and the load shall be gradually applied in the direction of the longitudinal axis of the resistor unit the applied load reached the requirement. The load shall be held for 10 seconds. The load of weight shall be ≥ 2.5 kg (24.5N).

(8) Periodic-Pulse Overload

Apply 4 times of rated voltage to the specimen at the 1 second on and 25 seconds off cycle, subjected to voltage application cycles specified in 10,000 time. The change of the resistance value shall be within ± 1.0% + 0.05 Ω

(9) Damp Heat Steady State

Place the specimen in a test chamber at 40 ± 2 °C and 90 ~ 95 % relative humidity. Apply the 0.1 times rated voltage to the specimen at the 1.5 hours on and 0.5 hour off cycle. The total length of test is 56 days. The change of the resistance value shall be within ± 5.0 % + 0.05 Ω

(10) Endurance at 70 °C

Placed in the constant temperature chamber of 70 ± 3 °C the resistor shall be connected to the lead wire at the point of 25mm. Length with each terminal, the resistors shall be arranged not much effected mutually by the temperature of the resistors and the excessive ventilation shall not be performed, for 90 minutes on and 30 minutes off under this condition the rated D.C. voltage is applied continuously for 1000+48/-0 hours then left at no-load for 1hour, measured at this time the resistance value °. The change of the resistance value shall be within ± 5.0 % + 0.05 Ω. There shall be no remarkable change in the appearance and the color code shall be legible after the test..

(11) Temperature Cycling Test

The temperature cycle shown in the following table shall be repeated 5 times consecutively. The measurement of the resistance value is done before the first cycle and after ending the fifth cycle, leaving in the room temperature for about 1 hour.

Temperature Cycling Conditions:

Step	Temperature(°C)	Time (minute)
1	-55 ± 3	30
2	25 ± 3	2 ~ 3
3	155 ± 3	30
4	25 ± 3	2 ~ 3

The change of the resistance value shall be within ± 1.0 % + 0.05 Ω. After the test the resistor shall be free from the electrical or mechanical damage.

(12) Resistance to Soldering Heat

The terminal lead shall be dipped into the solder pot at $260 \pm 3 \text{ }^\circ\text{C}$ for 10 ± 1.0 seconds up to 2.5 ~ 3.5 mm.

The change of the resistance value shall be within $\pm 1.0 \% + 0.05 \Omega$

(13) Accidental Overload Test (Only for silicone lacquer type)

At 4 times of the rated voltage or the maximum load voltage, whichever is the less, applied for 1 minute

$$\text{Overload Test Voltage} = 4 * \sqrt{\text{Power Rating} \cdot \text{Resistance Value}}$$

The resistor shall be able to no evidence of flaming arcing.

8. PACKING METHODS

Bandolier for Axial leads

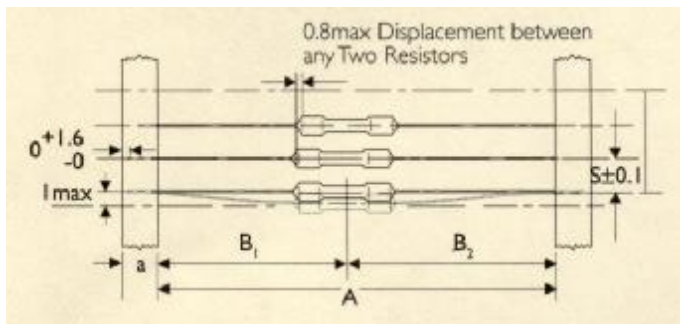

STYLE		DIMENSIONS				Unit: : mm	
Normal	Miniature	a	A	B1-B2	S (spacing)	T (max. deviation of spacing)	
HHV-25	HHV50S	6 ± 0.5	52.4 ± 1.0 26.0 ± 1.0	1.2 1.0	5		
HHV-50	HHV1SS	6 ± 0.5	52.4 ± 1.0	1.2	5	1 mm per 10 spacing	
HHV1WS	HHV2SS	6 ± 0.5	73.0 ± 1.5	1.5	5	0.5 mm per 5 spacing	
HHV2WS	HHV3SS	6 ± 0.5	52.4 ± 1.0 73.0 ± 1.5	1.2 1.5	10		

9. TAPE ON REEL PACKING

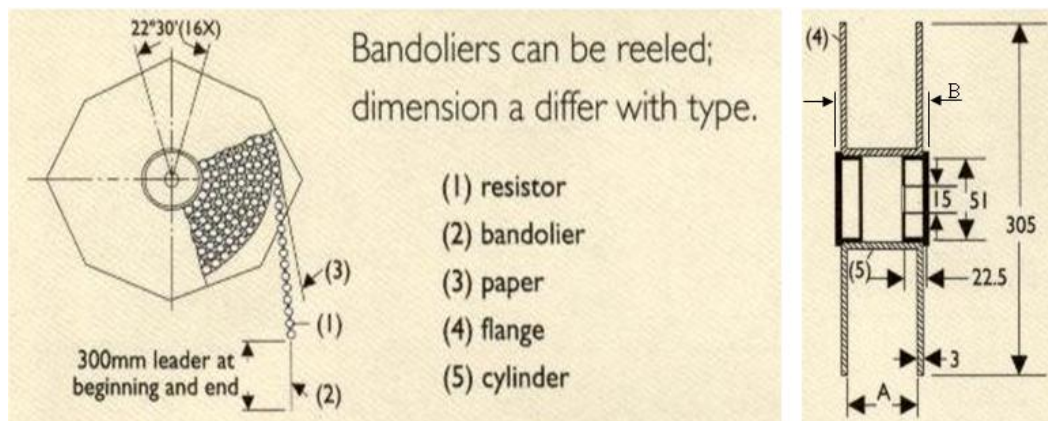

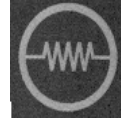

STYLE		TAPE ON REEL		
Normal	Miniature	A	B	Qty per reel
HHV-25	HHV50S	40/66.5	49/75.5	5,000
HHV-50	HHV1SS	66.5	75.5	2,500
HHV1WS	HHV2SS	87	96	2,000
HHV2WS	HHV3SS	87	96	1,000

10. TAPE ON BOX PACKING

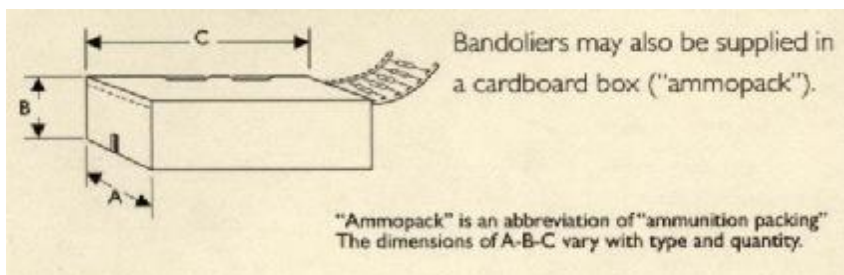

Unit: mm

STYLE		Standard Lead Length			Short Lead Length			Qty per box
Normal	Miniature	W (A)	H (B)	L (C)	W (A)	H (B)	L (C)	
HHV-25	HHV50S	81	104	260	48	102	255	5,000
HHV-50	HHV1SS	73	45	258	_____	_____	_____	1,000
HHV1WS	HHV2SS	103	78	260	81	91	260	1,000
HHV2WS	HHV3SS	103	94	260	81	91	260	1,000

11. SPECIAL TYPE (FORMING DIMENSIONS)

M TYPE

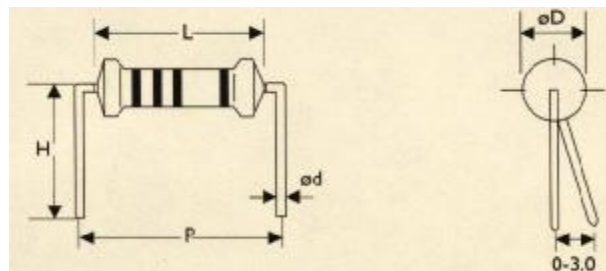

STYLE		DIMENSIONS					UNIT : mm
Normal	Miniature	L	ψD	ψd	P	H	
HHV-25	HHV50S	6.3 ± 0.5	2.4 ± 0.2	0.55 ± 0.05	10.0 ± 1	10.0 ± 1	
HHV-50	HHV1SS	9.0 ± 0.5	3.3 ± 0.3	0.55 ± 0.05	12.5 ± 1	10.0 ± 1	
HHV1WS	HHV2SS	11.5 ± 1.0	4.5 ± 0.5	0.8 ± 0.05	15.0 ± 1	12.5 ± 1	
HHV2WS	HHV3SS	15.5 ± 1.0	5.0 ± 0.5	0.8 ± 0.05	20.0 ± 1	15.0 ± 1	

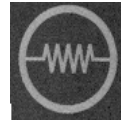

MB TYPE

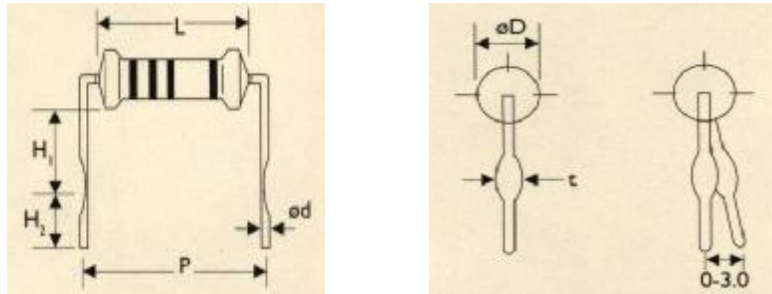

STYLE		DIMENSIONS							UNIT : mm
Normal	Miniature	L	ψD	ψd	P	H 1	H 2	t	
HHV-25	HHV50S	6.3 ± 0.5	2.4 ± 0.2	0.55 ± 0.05	10.0 ± 1	6.0 ± 1	5.0 ± 1	1.2 ± 0.2	
HHV-50	HHV1SS	9.0 ± 0.5	3.3 ± 0.3	0.8 ± 0.05	12.5 ± 1	6.0 ± 1	5.0 ± 1	1.2 ± 0.2	
HHV1WS	HHV2SS	11.5 ± 1.0	4.5 ± 0.5	0.8 ± 0.05	15.0 ± 1	6.0 ± 1	5.0 ± 1	1.4 ± 0.2	
HHV2WS	HHV3SS	15.5 ± 1.0	5.0 ± 0.5	0.8 ± 0.05	20.0 ± 1	10.0 ± 1	5.0 ± 1	1.4 ± 0.2	

F TYPE

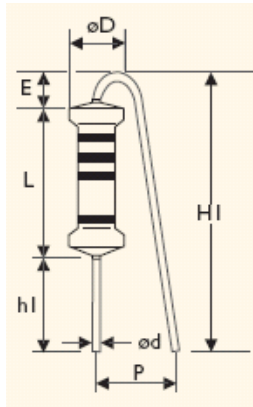

STYLE		DIMENSIONS							UNIT : mm
Normal	Miniature	L	ψD	ψd	P	h1	H1 max	E max	
HHV1WS	HHV2SS	11.5 ± 1.0	4.5 ± 0.5	0.8 ± 0.05	6.0 ± 1	5.0 ± 1	20	3.5	
HHV2WS	HHV3SS	15.5 ± 1.0	5.0 ± 0.5	0.8 ± 0.05	8.0 ± 1	5.0 ± 1	25	3.5	

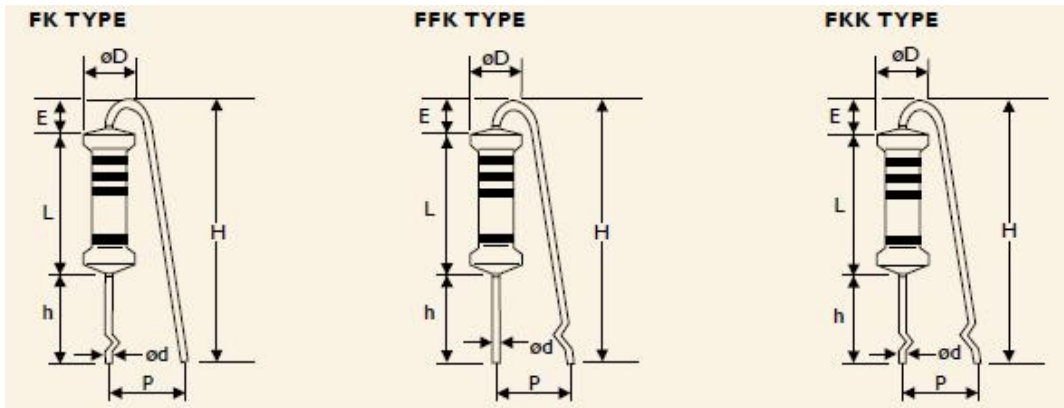
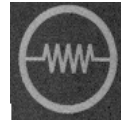

STYLE		DIMENSIONS					UNIT : mm	
Normal	Miniature	L	ψD	ψd	P	h	H max	E max
HHV1WS	HHV2SS	11.5 ± 1.0	4.5 ± 0.5	0.8 ± 0.05	6.0 ± 1	8.0 ± 1	24	3.5
HHV2WS	HHV3SS	15.5 ± 1.0	5.0 ± 0.5	0.8 ± 0.05	8.0 ± 1	8.0 ± 1	28	3.5

PN Type Forming for Taping (rated watts from 1/4W to 2SS size only)

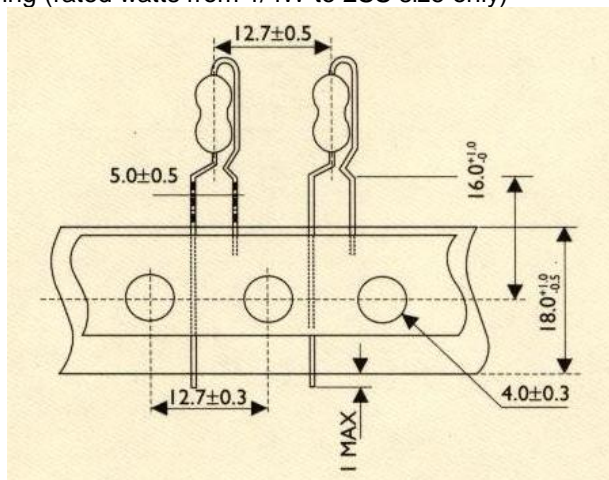

AV Type Forming for Taping (rated watts from 1/4W to 2SS size only)

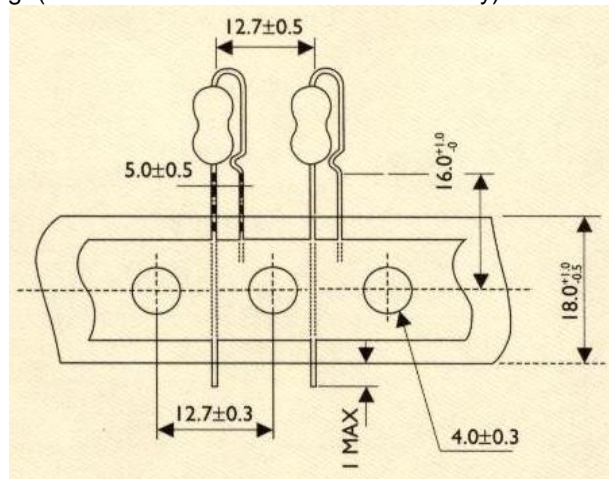

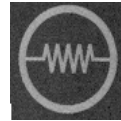

12. Plant Address

- A. China Dongguan Plant
7-1, Gaoli Road, Gaoli Industrial Zone
Tangxia Zhen, Dongguan, Guangdong, China
(廣東省東莞市塘廈鎮高麗工業區高麗路 7-1 號)
Tel. 86-769-8772 0275
Fax. 86-769-8772 0275 #4333

- B. China Mudu Plant
No.158, Jinchang Road, No.1 Building of NanBangIND.Zone,
Mu Du New District, Suzhou, China
(江蘇省蘇州市木瀆新區金長路 158 號南濱工業區 1 號)
Tel. 86-512-66518889
Fax. 86-512-66519889