

HEXFET® Power MOSFET

$V_{DS}$	<b>20</b>	<b>V</b>
$R_{DS(on) max}$ (@ $V_{GS} = 4.5V$ )	<b>30</b>	<b>mΩ</b>
$R_{DS(on) max}$ (@ $V_{GS} = 2.5V$ )	<b>45</b>	
$Q_g$ (typical)	<b>13</b>	<b>nC</b>
$I_D$ (@ $T_A = 25^\circ C$ )	<b>7.0</b>	<b>A</b>

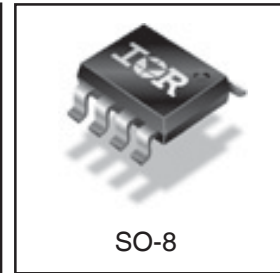
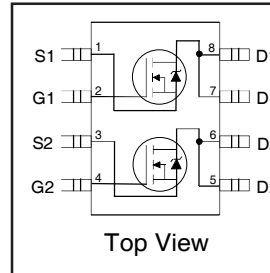

**Features**

Industry-standard pinout SO-8 Package
Compatible with Existing Surface Mount Techniques
RoHS Compliant, Halogen-Free
MSL1, Industrial qualification



**Benefits**

Multi-Vendor Compatibility
Easier Manufacturing
Environmentally Friendlier
Increased Reliability

Base Part Number	Package Type	Standard Pack		Orderable Part Number
		Form	Quantity	
IRF7331PbF-1	SO-8	Tape and Reel	4000	IRF7331TRPbF-1

**Absolute Maximum Ratings**

	Parameter	Max.	Units
$V_{DS}$	Drain- Source Voltage	20	V
$I_D @ T_A = 25^\circ C$	Continuous Drain Current, $V_{GS} @ 4.5V$	7.0	A
$I_D @ T_A = 70^\circ C$	Continuous Drain Current, $V_{GS} @ 4.5V$	5.5	
$I_{DM}$	Pulsed Drain Current ①	28	
$P_D @ T_A = 25^\circ C$	Power Dissipation ③	2.0	W
$P_D @ T_A = 70^\circ C$	Power Dissipation③	1.3	
	Linear Derating Factor	16	mW/°C
$V_{GS}$	Gate-to-Source Voltage	± 12	V
$T_J, T_{STG}$	Junction and Storage Temperature Range	-55 to + 150	°C

**Thermal Resistance**

Symbol	Parameter	Typ.	Max.	Units
$R_{\theta JL}$	Junction-to-Drain Lead	—	42	°C/W
$R_{\theta JA}$	Junction-to-Ambient ③	—	62.5	

**Electrical Characteristics @  $T_J = 25^\circ\text{C}$  (unless otherwise specified)**

	Parameter	Min.	Typ.	Max.	Units	Conditions
$V_{(BR)DSS}$	Drain-to-Source Breakdown Voltage	20	—	—	V	$V_{GS} = 0V, I_D = 250\mu A$
$\Delta V_{(BR)DSS}/\Delta T_J$	Breakdown Voltage Temp. Coefficient	—	0.013	—	V/°C	Reference to $25^\circ\text{C}, I_D = 1\text{mA}$
$R_{DS(on)}$	Static Drain-to-Source On-Resistance	—	—	30	m $\Omega$	$V_{GS} = 4.5V, I_D = 7.0A$ ②
		—	—	45		$V_{GS} = 2.5V, I_D = 5.6A$ ②
$V_{GS(th)}$	Gate Threshold Voltage	0.6	—	1.2	V	$V_{DS} = V_{GS}, I_D = 250\mu A$
$g_{fs}$	Forward Transconductance	14	—	—	S	$V_{DS} = 10V, I_D = 7.0A$
$I_{DSS}$	Drain-to-Source Leakage Current	—	—	1.0	$\mu A$	$V_{DS} = 16V, V_{GS} = 0V$
		—	—	25		$V_{DS} = 16V, V_{GS} = 0V, T_J = 70^\circ\text{C}$
$I_{GSS}$	Gate-to-Source Forward Leakage	—	—	100	nA	$V_{GS} = 12V$
	Gate-to-Source Reverse Leakage	—	—	-100		$V_{GS} = -12V$
$Q_g$	Total Gate Charge	—	13	20	nC	$I_D = 7.0A$
$Q_{gs}$	Gate-to-Source Charge	—	3.7	—		$V_{DS} = 10V$
$Q_{gd}$	Gate-to-Drain ("Miller") Charge	—	2.1	—		$V_{GS} = 4.5V$
$t_{d(on)}$	Turn-On Delay Time	—	7.6	—	ns	$V_{DD} = 10V$ ②
$t_r$	Rise Time	—	22	—		$I_D = 1.0A$
$t_{d(off)}$	Turn-Off Delay Time	—	110	—		$R_G = 53\Omega$
$t_f$	Fall Time	—	50	—		$V_{GS} = 4.5V$
$C_{iss}$	Input Capacitance	—	1340	—	pF	$V_{GS} = 0V$
$C_{oss}$	Output Capacitance	—	170	—		$V_{DS} = 16V$
$C_{rss}$	Reverse Transfer Capacitance	—	120	—		$f = 1.0\text{MHz}$

**Source-Drain Ratings and Characteristics**

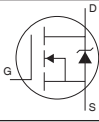
	Parameter	Min.	Typ.	Max.	Units	Conditions
$I_S$	Continuous Source Current (Body Diode)	—	—	2.0	A	MOSFET symbol showing the integral reverse p-n junction diode. 
$I_{SM}$	Pulsed Source Current (Body Diode) ①	—	—	28		
$V_{SD}$	Diode Forward Voltage	—	—	1.2	V	$T_J = 25^\circ\text{C}, I_S = 2.0A, V_{GS} = 0V$ ②
$t_{rr}$	Reverse Recovery Time	—	31	47	ns	$T_J = 25^\circ\text{C}, I_F = 2.0A$
$Q_{rr}$	Reverse Recovery Charge	—	15	23	nC	$di/dt = 100A/\mu s$ ②

**Notes:**

- ① Repetitive rating; pulse width limited by max. junction temperature.
- ② Pulse width  $\leq 400\mu s$ ; duty cycle  $\leq 2\%$ .
- ③ Surface mounted on 1 in square Cu board

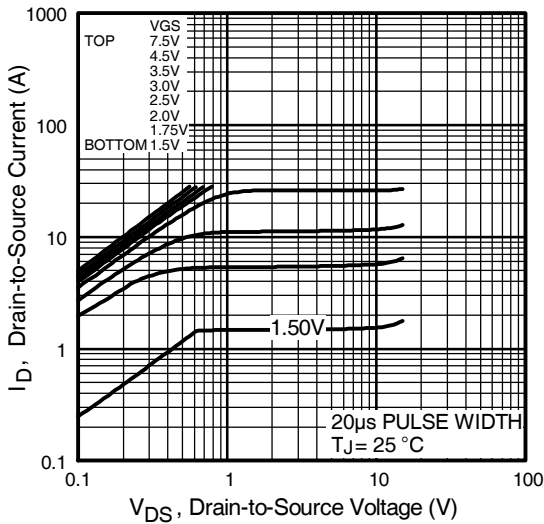
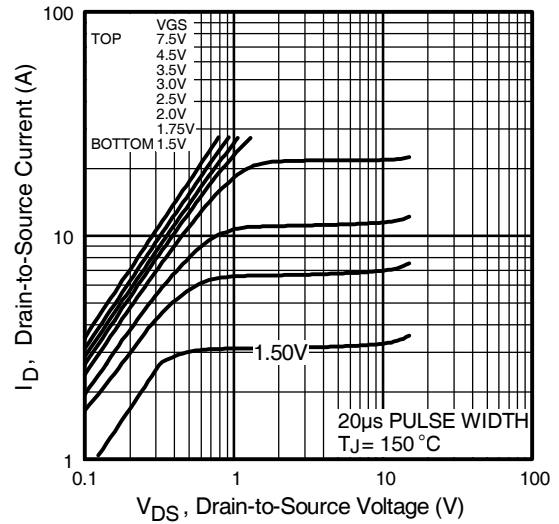
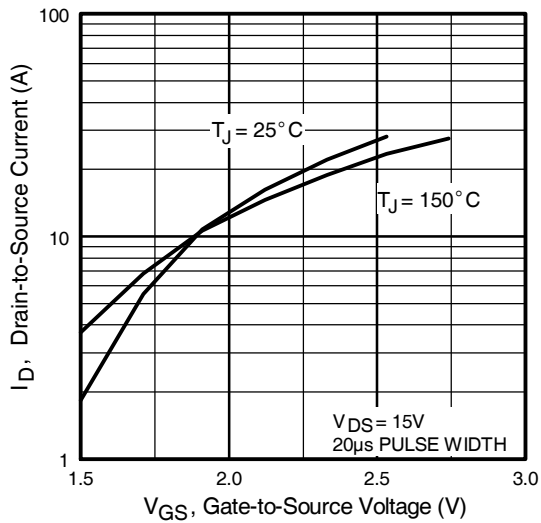
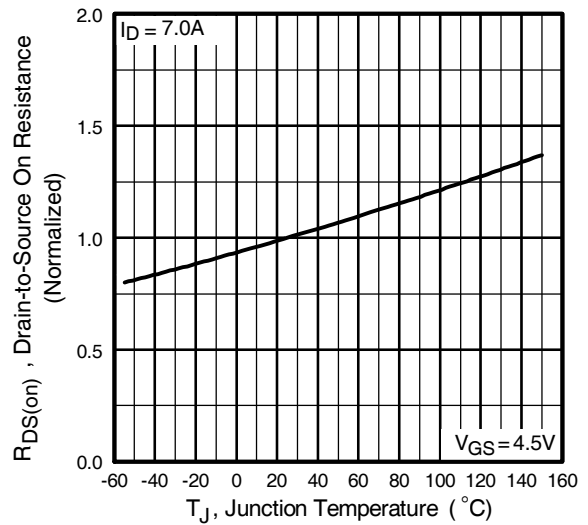
**Fig 1.** Typical Output Characteristics

**Fig 2.** Typical Output Characteristics

**Fig 3.** Typical Transfer Characteristics

**Fig 4.** Normalized On-Resistance Vs. Temperature

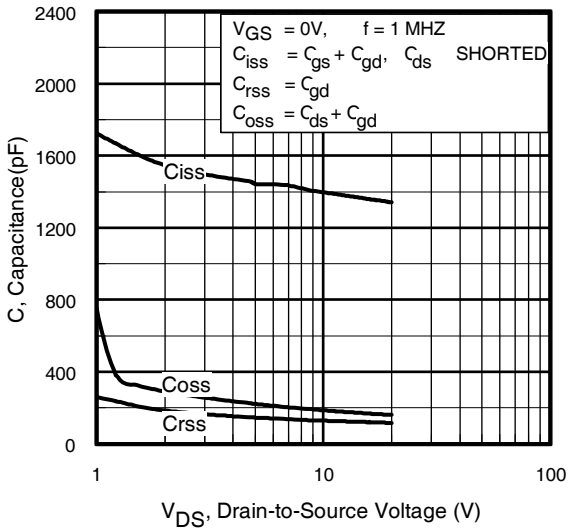

Fig 5. Typical Capacitance Vs. Drain-to-Source Voltage

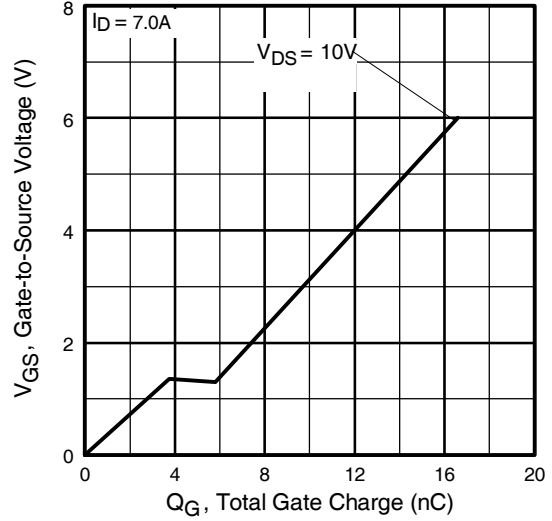

Fig 6. Typical Gate Charge Vs. Gate-to-Source Voltage

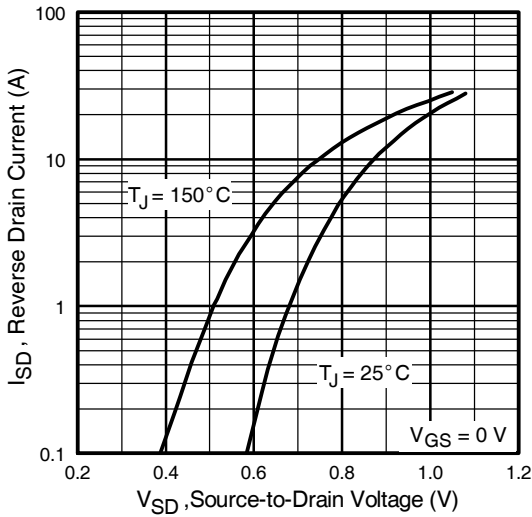

Fig 7. Typical Source-Drain Diode Forward Voltage

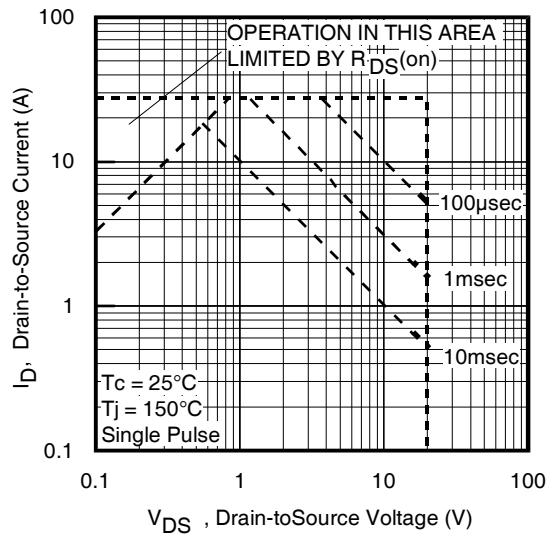
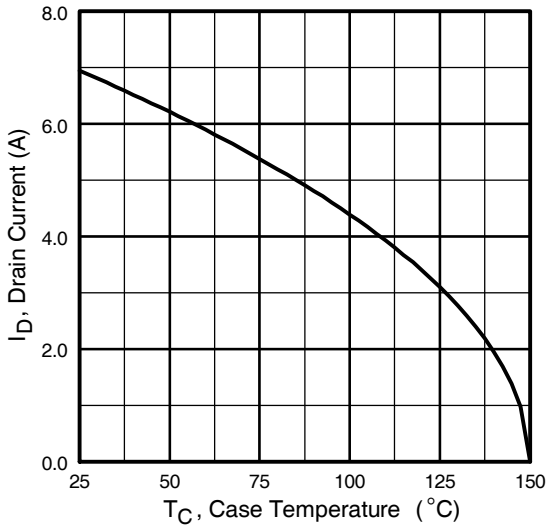
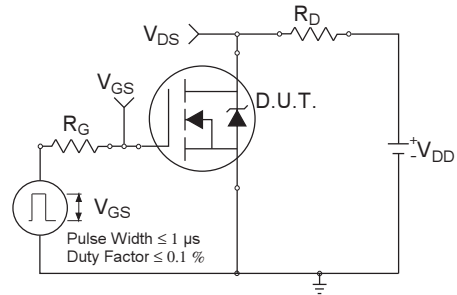

Fig 8. Maximum Safe Operating Area



**Fig 9.** Maximum Drain Current Vs. Case Temperature



**Fig 10a.** Switching Time Test Circuit

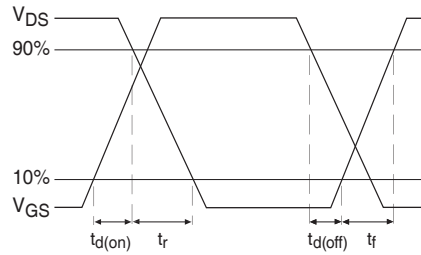

**Fig 10b.** Switching Time Waveforms

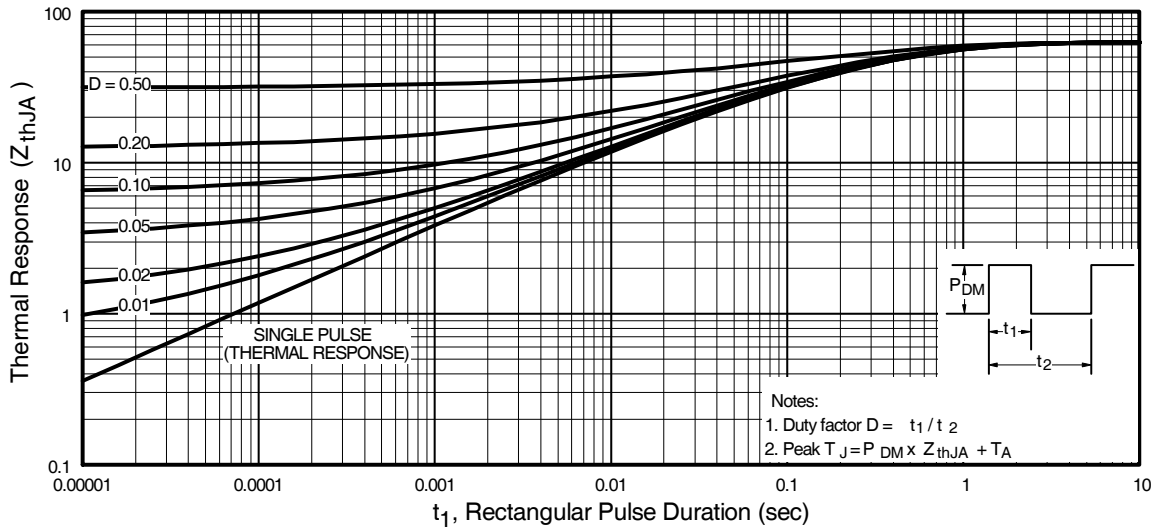

**Fig 11.** Maximum Effective Transient Thermal Impedance, Junction-to-Ambient

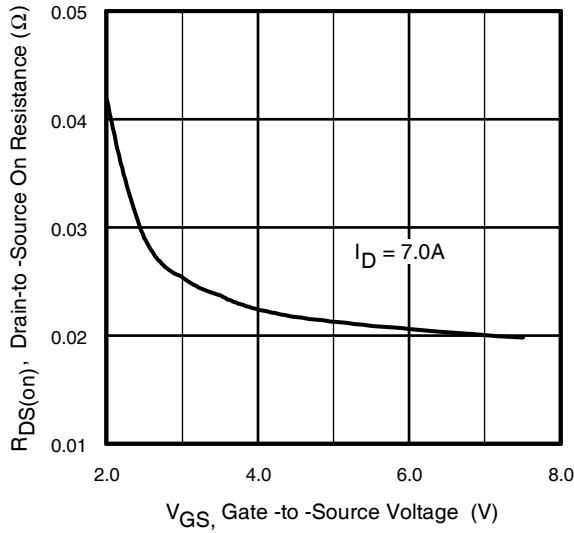

Fig 12. Typical On-Resistance Vs. Gate Voltage

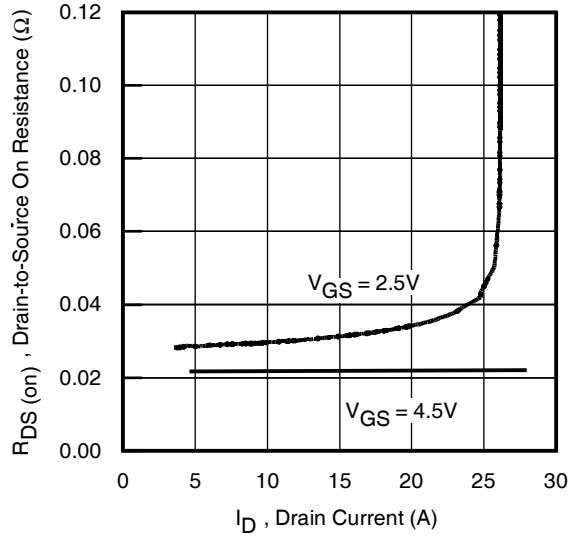

Fig 13. Typical On-Resistance Vs. Drain Current

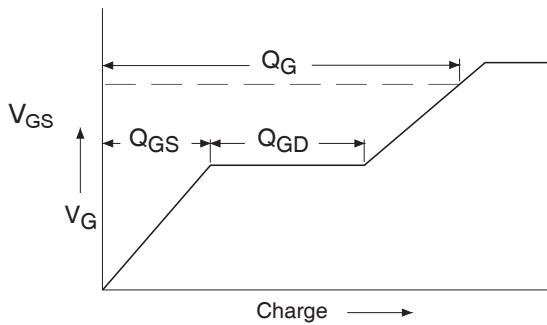

Fig 14a. Basic Gate Charge Waveform

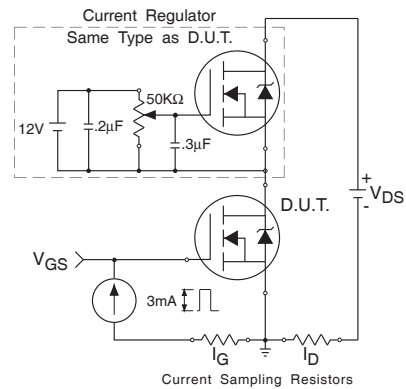
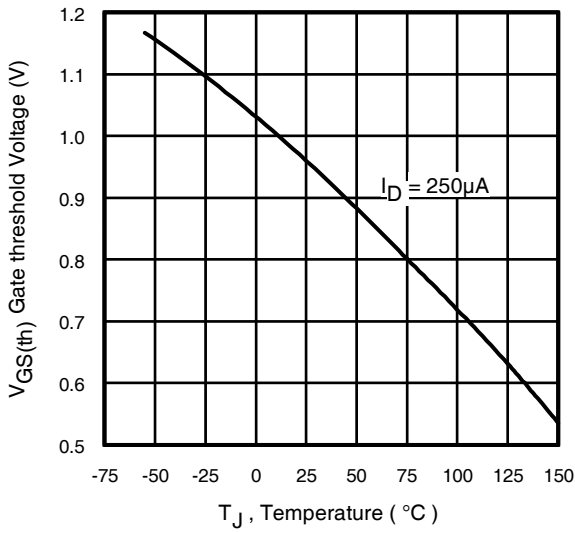
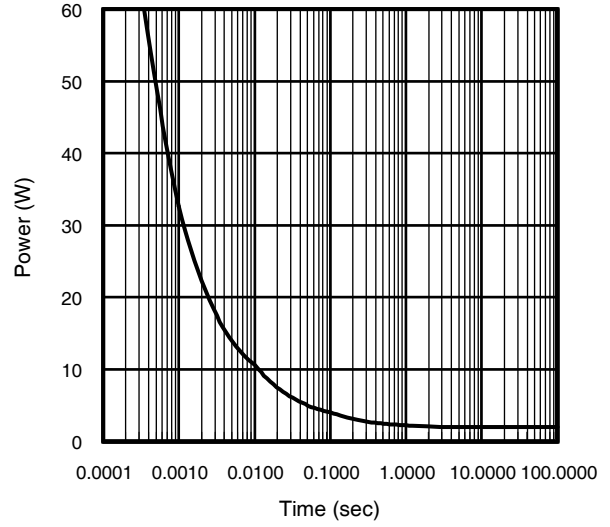

Fig 14b. Gate Charge Test Circuit



**Fig 15.** Typical V<sub>gs(th)</sub> Vs. Junction Temperature

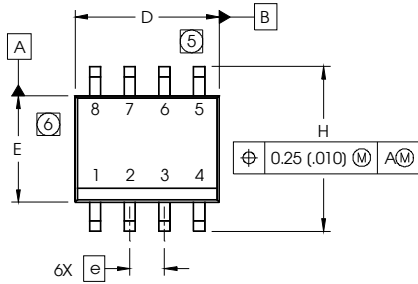

**Fig 16.** Typical Power Vs. Time



# SO-8 Package Outline (MOSFET & Fetky)

Dimensions are shown in millimeters (inches)



DIM	INCHES		MILLIMETERS	
	MIN	MAX	MIN	MAX
A	.0532	.0688	1.35	1.75
A1	.0040	.0098	0.10	0.25
b	.013	.020	0.33	0.51
c	.0075	.0098	0.19	0.25
D	.189	.1968	4.80	5.00
E	.1497	.1574	3.80	4.00
e	.050 BASIC		1.27 BASIC	
e1	.025 BASIC		0.635 BASIC	
H	.2284	.2440	5.80	6.20
K	.0099	.0196	0.25	0.50
L	.016	.050	0.40	1.27
y	0°	8°	0°	8°

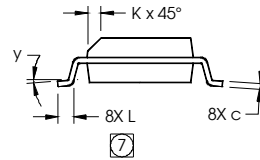
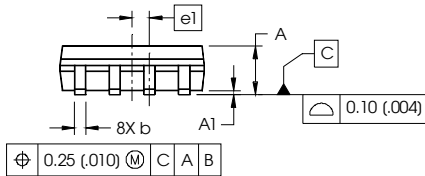

- NOTES:
1. DIMENSIONING & TOLERANCING PER ASME Y14.5M-1994.
  2. CONTROLLING DIMENSION: MILLIMETER
  3. DIMENSIONS ARE SHOWN IN MILLIMETERS (INCHES).
  4. OUTLINE CONFORMS TO JEDEC OUTLINE MS-012AA.
  5. DIMENSION DOES NOT INCLUDE MOLD PROTRUSIONS. MOLD PROTRUSIONS NOT TO EXCEED 0.15 (.006).
  6. DIMENSION DOES NOT INCLUDE MOLD PROTRUSIONS. MOLD PROTRUSIONS NOT TO EXCEED 0.25 (.010).
  7. DIMENSION IS THE LENGTH OF LEAD FOR SOLDERING TO A SUBSTRATE.

FOOTPRINT

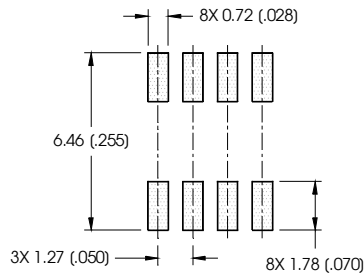

## SO-8 Part Marking Information

EXAMPLE: THIS IS AN IRF7101 (MOSFET)

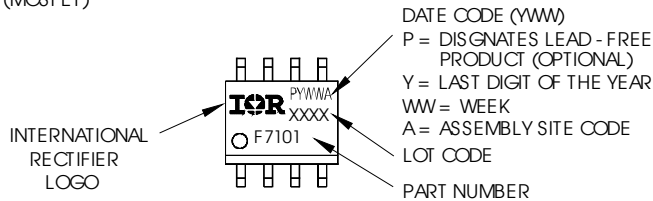

Note: For the most current drawing please refer to IR website at: <http://www.irf.com/package/>



**SO-8 Tape and Reel**

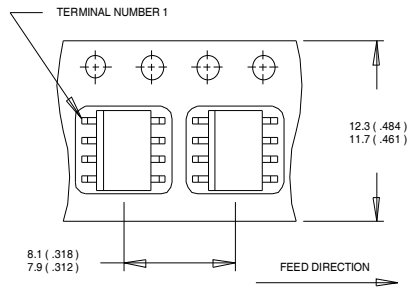

- NOTES:  
 1. CONTROLLING DIMENSION : MILLIMETER.  
 2. ALL DIMENSIONS ARE SHOWN IN MILLIMETERS(INCHES).  
 3. OUTLINE CONFORMS TO EIA-481 & EIA-541.

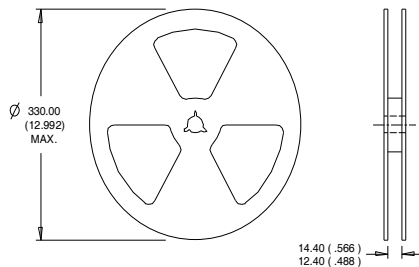

- NOTES :  
 1. CONTROLLING DIMENSION : MILLIMETER.  
 2. OUTLINE CONFORMS TO EIA-481 & EIA-541.

Note: For the most current drawing please refer to IR website at: <http://www.irf.com/package/>

**Qualification information†**

Qualification level	Industrial (per JEDEC JESD47F <sup>††</sup> guidelines)	
Moisture Sensitivity Level	SO-8	ML1 (per JEDEC J-STD-020D <sup>††</sup> )
RoHS compliant	Yes	

† Qualification standards can be found at International Rectifier's web site: <http://www.irf.com/product-info/reliability>

†† Applicable version of JEDEC standard at the time of product release

**Revision History**

Date	Comments
10/16/2014	<ul style="list-style-type: none"> <li>Corrected part number from "IRF7331PbF-1" to "IRF7331TRPbF-1" -all pages</li> <li>Removed the "IRF7331PbF-1" bulk part number from ordering information on page1</li> </ul>