



Hall Effect Sensor IC with Thermal Lock Protection and Auto Restart Function

Features:

- Operate from 2.8V to 36V supply voltage.
- On-chip Hall sensor.
- Internal bandgap regulator allows temperature compensated operations and a wide operating voltage range.
- High output sinking capability up to 500mA for driving large load.
- Lower current change rate reduces the peak output voltages during switching.
- Available in rugged low profile SOT-25 , SIP-4L packages.
- Built-in **PWM** Speed Control function .
- Built-in protection diode for reverse power supply fault.
- Built-in **thermal lock protection** and **auto-restart** function.

General Description:

WSH413 is designed to integrate Hall sensor with complementary output drivers and frequency generator together on the same chip, it is suitable for speed measurement, revolution counting, positioning, and DC brushless motors. It includes a temperature compensated voltage regulator, a differential amplifier, a Hysteresis controller, two Darlington output drivers capable of sinking 500mA current load and an PWM signal input pin capable of doing speed control. An on-chip protection diode is implemented to prevent reverse power fault. And built-in **thermal lock protection** and **auto-restart** function is suitable for super high speed fan. It can replace the function of lock protection and auto restart function. The power will be shutdown automatically at 125°C to prevent the coils be damaged and auto-restart after cooling down 5~10°C when thermal protected was activated .

The temperature-dependent bias increases the supply voltage of the hall plates and adjusts the switching points to the decreasing induction of magnets at higher temperatures. Subsequently, the open collector output switches to the appropriate state. WSH413 are rated for operation over temperature range from -20° C to 100°C and voltage ranges from 2.8V to 36V.

Winson reserves the right to make changes to improve reliability or manufacturability.

**Pin Descriptions: SOT-25**

Name	P/I/O	Pin#	Description
VDD	P	1	Positive Power Supply
Vss	P	2	Ground
PS	I	3	PWM Input Pin
OUT2	O	4	Output Pin 2
OUT1	O	5	Output Pin 1

Pin Descriptions: SIP-4L

Name	P/I/O	Pin#	Description
Vcc	P	1	Positive Power Supply
OUT1	O	2	Output Pin #1
OUT2	O	3	Output Pin #2
Vss	P	4	Ground

Absolute Maximum Rating (at Ta=25° C)

Supply Voltage	Vcc	-----	36V	
Output / FG breakdown Voltage	Vout/Vfg	-----	46V	
Magnetic flux density	B	-----	Unlimited	
Reverse Protection Voltage	Vr	-----	36V	
Output Current	Ic	-----	350mA	
	Hold current	Ih	-----	500mA
	Peak current	Ip	-----	1.0A
Operating Temperature Range	Ta	-----	(-20°C to +100°C)	
Storage Temperature Range	Ts	-----	(-65°C to +150°C)	
Package Power Dissipation	Pd	-----	350mw for SOT-25 500mw for SIP-4L	

Electrical Characteristics:

(T=+25° C, Vcc=2.8V to 36V)

Characteristic	Symbol	Test Conditions	Min	Typ	Max	Units
Supply Voltage	Vcc	—	2.8	—	36	V
Output Saturation Voltage	Vout(sat)	Vcc=24V, Ic=200mA B > Bop	—	0.75	1.0	V
Output Leakage Current	Ileakage	Vcc=24V, B < Brp	—	<0.1	10	uA
Supply Current	Isupply	Vcc=24V, Output & FG Open	—	5	10	mA
Output / FG Rising Time	Tr	Vcc=12V, RL=820Ω CL=20Pf	—	3.0	10	us
Output / FG Falling Time	Tf	Vcc=12V, RL=820Ω CL=20Pf	—	0.3	1.5	us

Winson reserves the right to make changes to improve reliability or manufacturability.

Function Block:

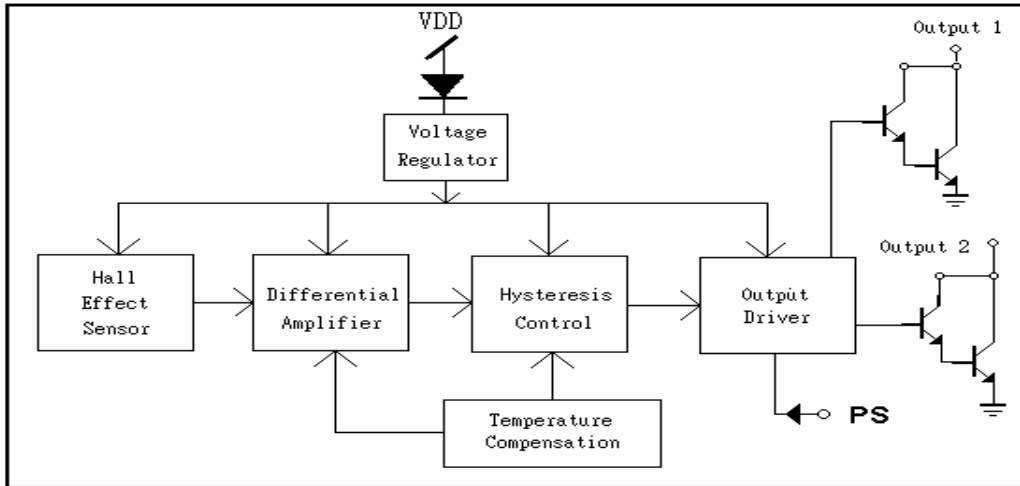

Magnetic Characteristics:

Characteristics	Symbol	Quantity	Ta= -20°C to +100°C			Unit
			Min	Typ.	Max	
Operate Point	Bop	Grade A		25	50	Gauss
		Grade B		30	70	
		Grade C		50	120	
Release Point	Brp	Grade A	-70	-25		Gauss
		Grade B	-100	-30		
		Grade C	-120	-50		
Hysteresis Window	Bop-Brp			40	200	Gauss

Ordering Information:

SIP- 4L: WSH413-XPAN <input type="checkbox"/> SOT-25: WSH413-XPDN <input type="checkbox"/> <div style="display: flex; align-items: center;"> <div style="border-left: 1px solid black; border-bottom: 1px solid black; width: 20px; height: 20px; margin-right: 5px;"></div> Elec. Grade </div> <p 10px;"="" color:="" margin-top:="" red;="" style="">N: Non-lead Process</p>	Elec. Grade SIP-4L : 1: A Grade (50 Gauss) 2: B Grade (70 Gauss) 3: C Grade (120 Gauss) SOT-25: 1: A Grade (50 Gauss) 2: B Grade (70 Gauss)
---	--

Winson reserves the right to make changes to improve reliability or manufacturability.

WSH413 Complementary Output1 vs. Output2/Vfg

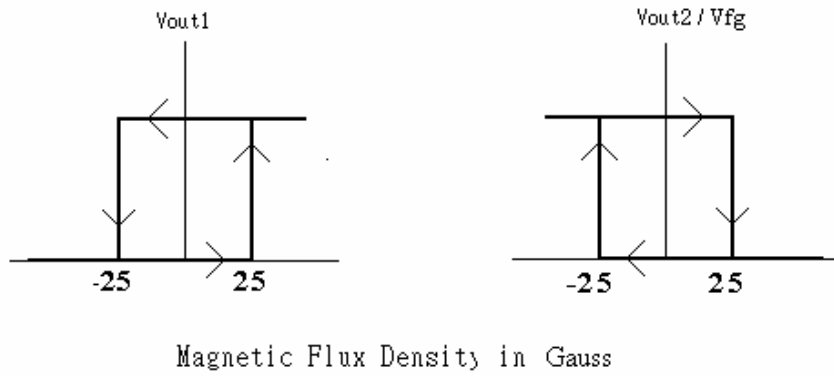

Test Circuit:

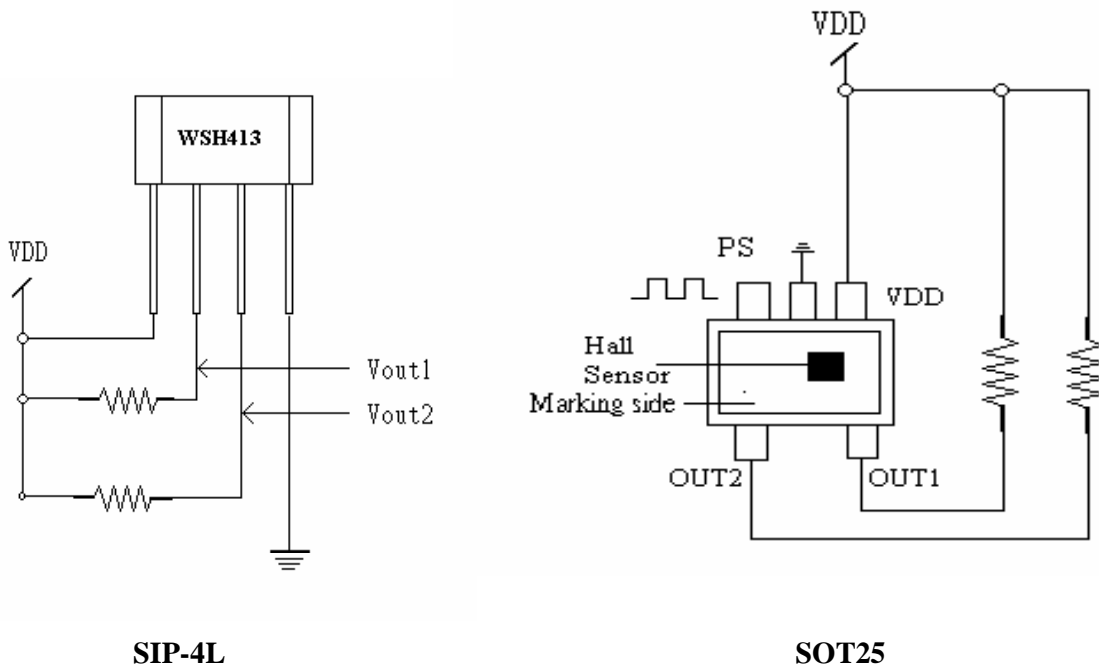

Winson reserves the right to make changes to improve reliability or manufacturability.

Package Information:

SOT-25

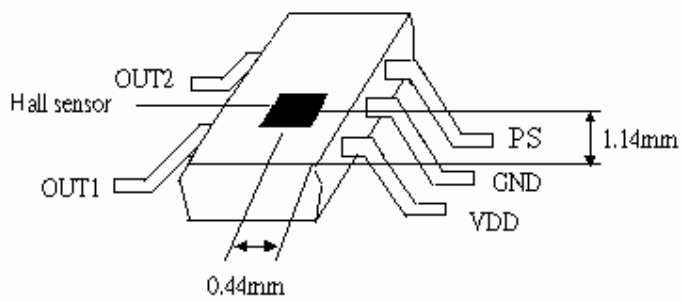
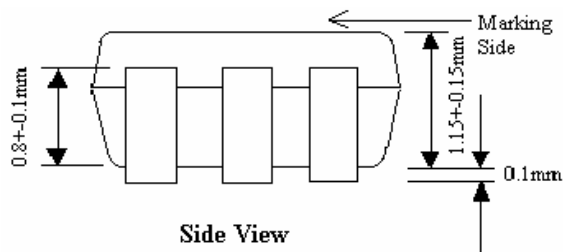
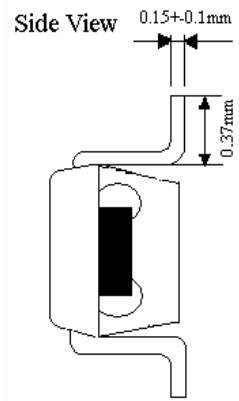
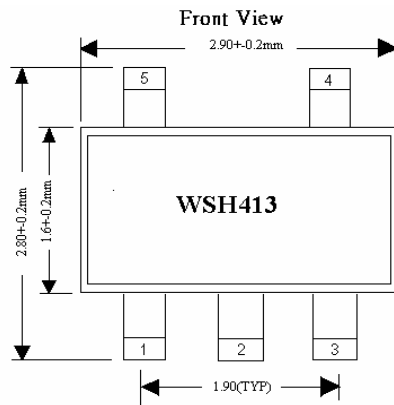

Winson reserves the right to make changes to improve reliability or manufacturability.

Package Dimension

Hall Sensor Location

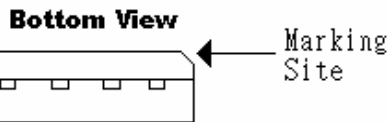
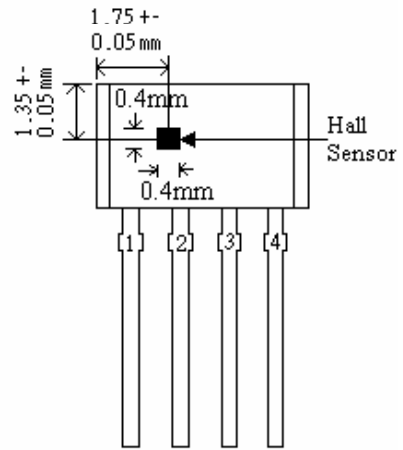
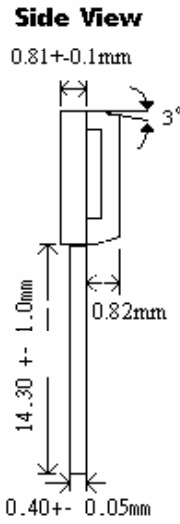
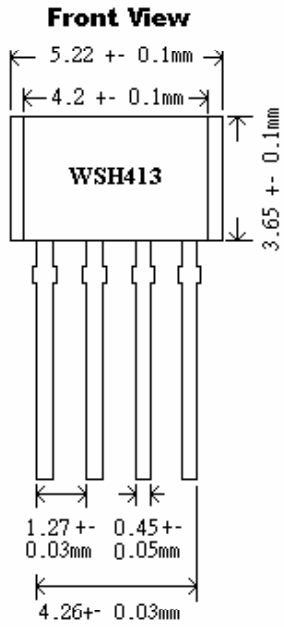
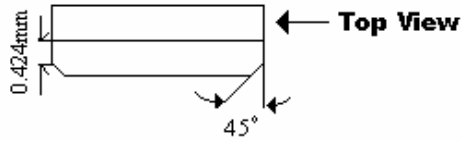

Application Circuit:

SOT-25

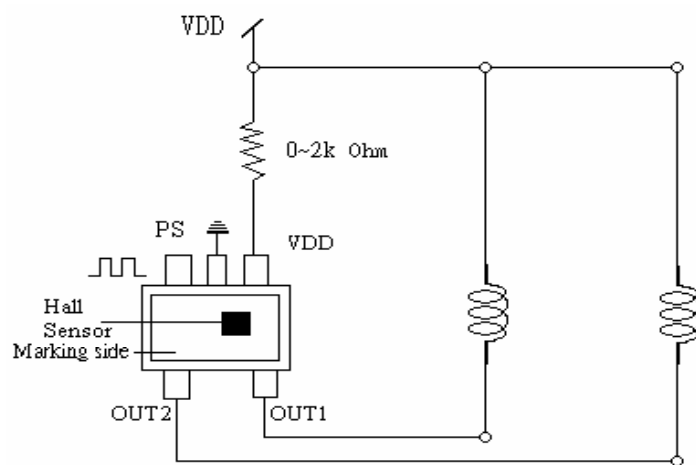

Figure 1.

SIP-4L

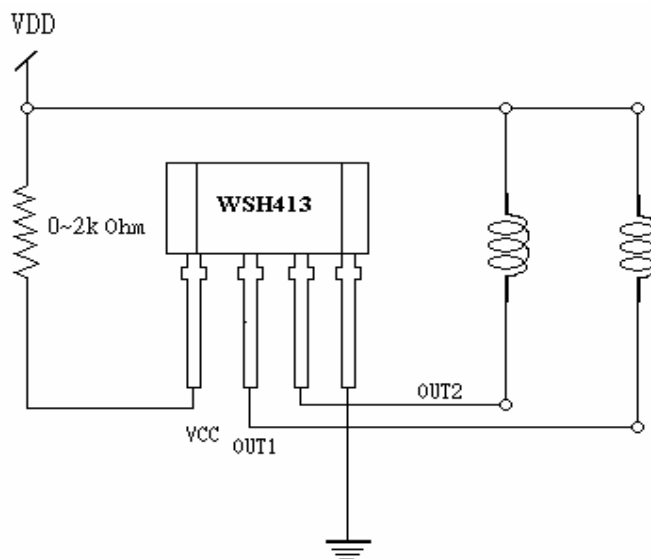

Figure 2.

Put additional resistor between **Power line** and **Pin 1** of WSH413 can greatly increase the surge voltage protection ability of system.

Winson reserves the right to make changes to improve reliability or manufacturability.