

# ZH CONNECTOR

1.5mm pitch/Disconnectable Crimp style connectors



The ZH connector is very small with a mounting height of 5.6mm and a thickness of only 3.5mm. Contact retention lances on the housing make insertion easier, while the dimple at the center of the contact ensures reliable contact with the post.

- Compact, low profile design
- Housing lances
- Reliable contact construction
- Distortion resistant construction
- Compatible with the ZR insulation displacement connectors

## Specifications

- Current rating: 1.0A AC, DC (AWG #26)
- Voltage rating: 50V AC, DC
- Temperature range: -25°C to +85°C  
(including temperature rise in applying electrical current)
- Contact resistance: Initial value/20m Ω max.  
After environmental testing/30m Ω max.
- Insulation resistance: 500M Ω min.
- Withstanding voltage: 500V AC/minute
- Applicable wire: AWG #32 to #26
- Applicable PC board thickness: 0.6 to 1.2mm, 1.6mm
- \* RoHS compliant products are published.
- \* Refer to "General Instruction and Notice when using Terminals and Connectors" at the end of this catalog.
- \* Contact JST for details.

## Standards

- Ⓜ Recognized E60389
- Ⓢ Certified LR20812
- ⚠ R9351092

## PC board layout and Assembly layout

<Through-hole type (viewed from soldering side) >

### Top entry type

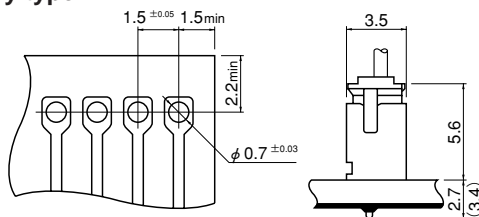

### Side entry type

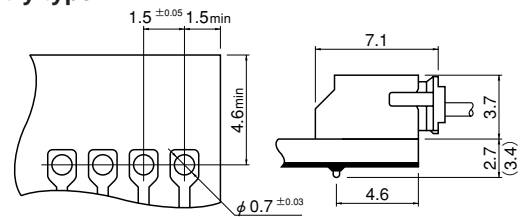

Note: 1. Tolerances are non-cumulative: ±0.05mm for all centers.

2. Hole dimension differ according to the kind of PC board and piercing method. If PC boards made of hard material are used, the hole dimensions should be larger. The dimensions above should serve as a guideline. Contact JST for details.

<SMT type (viewed from component side) >

### SM2 type

#### Side entry type

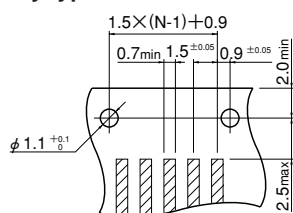

### SM4 type

#### Top entry type

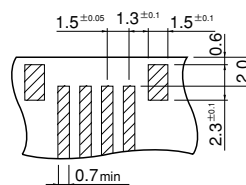

#### Side entry type

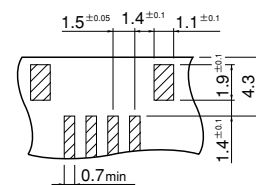

Note: 1. N...Number of circuits

2. Tolerances are non-cumulative: ±0.05mm for all centers.

3. The dimensions above should serve as a guideline. Contact JST for details.

# ZH CONNECTOR

## Contact

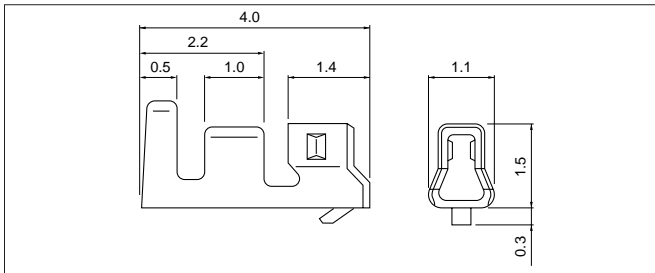

Contact	Crimping machine	Applicator		
		Crimp applicator	Dies	Crimp applicator with dies
SZH-002T-P0.5	AP-K2N	MKS-L	MK/SZH-002-05	APLMK SZH002-05

Note: \*Strip-crimp applicator.

Model No.	Applicable wire			Qty / reel
	mm <sup>2</sup>	AWG#	Insulation O.D. (mm)	
SZH-002T-P0.5	0.08 ~0.13	28~26	0.8~1.1	13,000
SZH-003T-P0.5	0.032~0.08	32~28	0.5~0.9	16,000

### Material and Finish

Phosphor bronze, tin-plated (reflow treatment)

### RoHS compliance

Contact	Crimping machine	Applicator		
		Crimp applicator	Dies	Crimp applicator with dies
SZH-003T-P0.5	AP-K2N	MKS-L	MK/SZH-003-05	APLMK SZH003-05
		*MKS-SC	SC/SZH-003-05	APLSC SZH003-05

## Housing

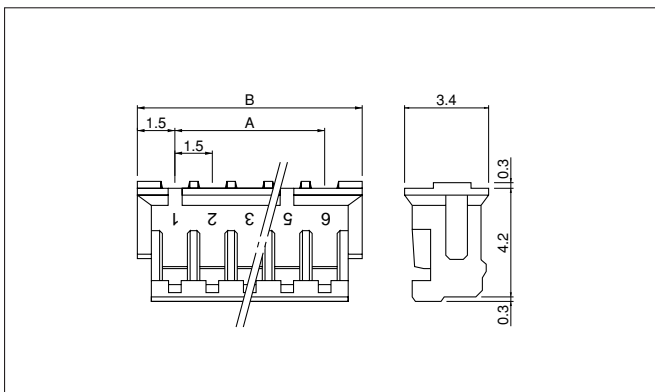

<For reference> As the color identification, the following alphabet shall be put in the underlined part. For availability, delivery and minimum order quantity, contact JST.

ex. **ZHR-2-oo**

(blank)...natural (white)

K...black R...red E...blue M...green

Circuits	Model No.	Dimensions (mm)		Qty / bag
		A	B	
2	ZHR-2	1.5	4.5	1,000
3	ZHR-3	3.0	6.0	1,000
4	ZHR-4	4.5	7.5	1,000
5	ZHR-5	6.0	9.0	1,000
6	ZHR-6	7.5	10.5	1,000
6	ZHR-6(3.0)	15.0	18.0	1,000
7	ZHR-7	9.0	12.0	1,000
8	ZHR-8	10.5	13.5	1,000
9	ZHR-9	12.0	15.0	1,000
10	ZHR-10	13.5	16.5	1,000
11	ZHR-11	15.0	18.0	1,000
12	ZHR-12	16.5	19.5	1,000
13	ZHR-13	18.0	21.0	1,000

### Material

PA 66, UL94V-0, natural (white)

### RoHS compliance

Note: 1. ZHR-6(3.0) is 6 circuits 3.0mm pitch plugged up.

As for this housing, only circuit No.1 is marked.

2. ZHR-6(3.0) is not UL/CSA/TÜV approved.

## Through-hole type shrouded header

### Top entry type

#### (2 circuits)

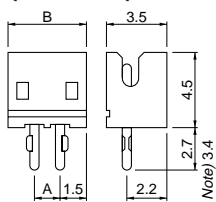

#### (3 circuits or more)

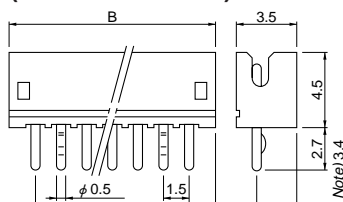

### Side entry type

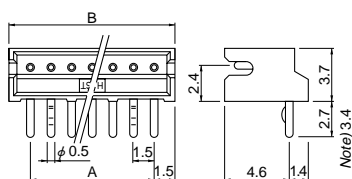

Circuits	Model No.				Dimensions (mm)		Qty / box		
	Top entry type	Side entry type	Note) Top entry type	Note) Side entry type	A	B	Top entry type	Side entry type	Side entry type-3.4
2	B2B-ZR	S2B-ZR	B2B-ZR-3.4	S2B-ZR-3.4	1.5	4.5	2,000	2,000	2,000
3	B3B-ZR	S3B-ZR	B3B-ZR-3.4	S3B-ZR-3.4	3.0	6.0	2,000	2,000	1,000
4	B4B-ZR	S4B-ZR	B4B-ZR-3.4	S4B-ZR-3.4	4.5	7.5	2,000	2,000	2,000
5	B5B-ZR	S5B-ZR	B5B-ZR-3.4	S5B-ZR-3.4	6.0	9.0	2,000	1,000	1,000
6	B6B-ZR	S6B-ZR	B6B-ZR-3.4	S6B-ZR-3.4	7.5	10.5	2,000	1,000	1,000
7	B7B-ZR	S7B-ZR	B7B-ZR-3.4	S7B-ZR-3.4	9.0	12.0	1,000	1,000	1,000
8	B8B-ZR	S8B-ZR	B8B-ZR-3.4	S8B-ZR-3.4	10.5	13.5	1,000	1,000	1,000
9	B9B-ZR	S9B-ZR	B9B-ZR-3.4	S9B-ZR-3.4	12.0	15.0	1,000	1,000	1,000
10	B10B-ZR	S10B-ZR	B10B-ZR-3.4	S10B-ZR-3.4	13.5	16.5	1,000	1,000	1,000
11	B11B-ZR	S11B-ZR	B11B-ZR-3.4	S11B-ZR-3.4	15.0	18.0	1,000	500	500
12	B12B-ZR	S12B-ZR	B12B-ZR-3.4	S12B-ZR-3.4	16.5	19.5	1,000	500	500
13	B13B-ZR	S13B-ZR	B13B-ZR-3.4	S13B-ZR-3.4	18.0	21.0	500	500	500

### Material and Finish

Pin: Brass, copper-undercoated, tin-plated (reflow treatment)

Wafer: Glass-filled PA 66, UL94V-0, natural (ivory)

### RoHS compliance

This product displays (LF)(SN) on a label.

Note: Headers with 3.4mm long solder tails, suited for the 1.6mm thick PC board.

<For reference> As the color identification, the following alphabet shall be put in the underlined part. For availability, delivery and minimum order quantity, contact JST.

ex. **B2B-ZR-3.4-oo**

(blank)...natural (ivory)

K...black R...red E...blue M...green

# ZH CONNECTOR

## SMT type shrouded header

### SM2 type Side entry type

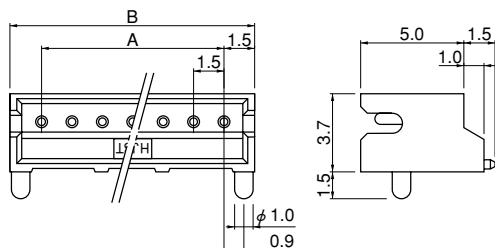

### SM4 type (with solder tabs) Top entry type

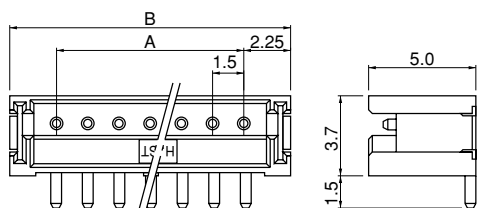

### Side entry type

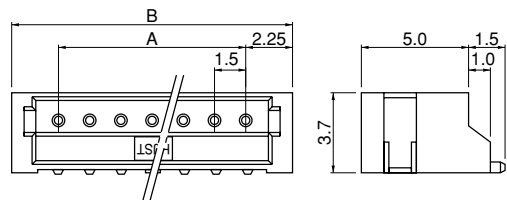

### SM2 type

Circuits	Model No. Side entry type	Dimensions (mm)		Q'ty / reel
		A	B	
2	<b>S2B-ZR-SM2-TF</b>	1.5	4.5	1,000
3	<b>S3B-ZR-SM2-TF</b>	3.0	6.0	1,000
4	<b>S4B-ZR-SM2-TF</b>	4.5	7.5	1,000
5	<b>S5B-ZR-SM2-TF</b>	6.0	9.0	1,000
6	<b>S6B-ZR-SM2-TF</b>	7.5	10.5	1,000
7	<b>S7B-ZR-SM2-TF</b>	9.0	12.0	1,000
8	<b>S8B-ZR-SM2-TF</b>	10.5	13.5	1,000
9	<b>S9B-ZR-SM2-TF</b>	12.0	15.0	1,000
10	<b>S10B-ZR-SM2-TF</b>	13.5	16.5	1,000
11	<b>S11B-ZR-SM2-TF</b>	15.0	18.0	1,000
12	<b>S12B-ZR-SM2-TF</b>	16.5	19.5	1,000
13	<b>S13B-ZR-SM2-TF</b>	18.0	21.0	1,000

#### Material and Finish

Pin: Brass, copper-undercoated, tin-plated (reflow treatment)  
Wafer: Glass-filled PA 46, UL94V-0, natural (ivory)

**RoHS compliance** This product displays (LF)(SN) on a label.

### SM4 type

Circuits	Model No.		Dimensions (mm)		Q'ty / reel	
	Top entry type	Side entry type	A	B	Top entry type	Side entry type
2	<b>B2B-ZR-SM4-TF</b>	<b>S2B-ZR-SM4A-TF</b>	1.5	6.0	1,000	1,000
3	<b>B3B-ZR-SM4-TF</b>	<b>S3B-ZR-SM4A-TF</b>	3.0	7.5	1,000	1,000
4	<b>B4B-ZR-SM4-TF</b>	<b>S4B-ZR-SM4A-TF</b>	4.5	9.0	1,000	1,000
5	<b>B5B-ZR-SM4-TF</b>	<b>S5B-ZR-SM4A-TF</b>	6.0	10.5	1,000	1,000
6	<b>B6B-ZR-SM4-TF</b>	<b>S6B-ZR-SM4A-TF</b>	7.5	12.0	1,000	1,000
7	<b>B7B-ZR-SM4-TF</b>	<b>S7B-ZR-SM4A-TF</b>	9.0	13.5	1,000	1,000
8	<b>B8B-ZR-SM4-TF</b>	<b>S8B-ZR-SM4A-TF</b>	10.5	15.0	1,000	1,000
9	<b>B9B-ZR-SM4-TF</b>	<b>S9B-ZR-SM4A-TF</b>	12.0	16.5	1,000	1,000
10	<b>B10B-ZR-SM4-TF</b>	<b>S10B-ZR-SM4A-TF</b>	13.5	18.0	1,000	1,000
11	<b>B11B-ZR-SM4-TF</b>	<b>S11B-ZR-SM4A-TF</b>	15.0	19.5	1,000	1,000
12	<b>B12B-ZR-SM4-TF</b>	<b>S12B-ZR-SM4A-TF</b>	16.5	21.0	1,000	1,000
13	<b>B13B-ZR-SM4-TF</b>	<b>S13B-ZR-SM4A-TF</b>	18.0	22.5	1,000	1,000

#### Material and Finish

Pin: Brass, copper-undercoated, tin-plated (reflow treatment)□  
Wafer: PA 6T, UL94V-0, natural (ivory)□  
Solder tab: Brass, copper-undercoated, tin-plated (reflow treatment)

**RoHS compliance** This product displays (LF)(SN) on a label.

Note: 1. The products listed above are supplied on embossed-tape.

2. Contact JST for the top entry type headers with suction cap.

<For reference> As the color identification, the following alphabet shall be put in the underlined part.

For availability, delivery and minimum order quantity, contact JST.

ex. **S2B-ZR-SM4A-oo-TF**

(blank)...natural (ivory)

K...black R...red E...blue M...green

## Taping specifications

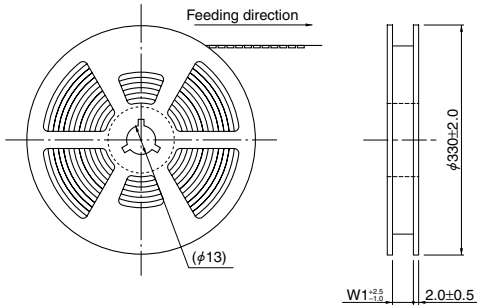

**SM2 type**  
(Side entry type) 2 to 11 circuits  
**SM4 type**  
(Side entry type) 2 to 10 circuits

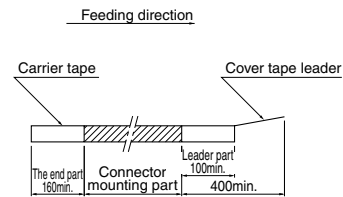

**SM2 type**  
(Side entry type) 12 to 13 circuits  
**SM4 type**  
(Side entry type) 11 to 13 circuits

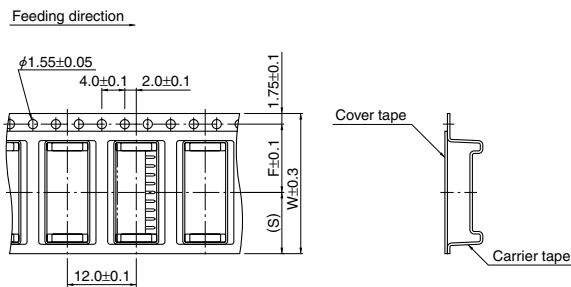

**SM4 type**  
(Top entry type)  
2 to 10 circuits

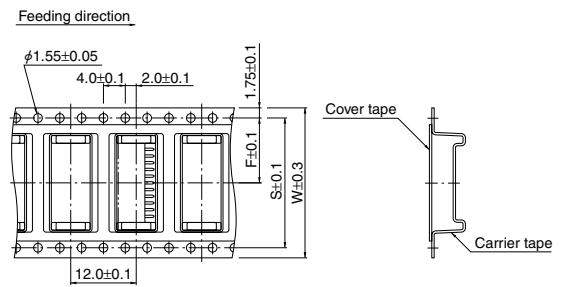

**SM4 type**  
(Top entry type)  
11 to 13 circuits

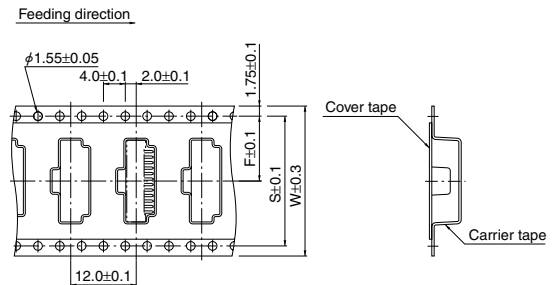
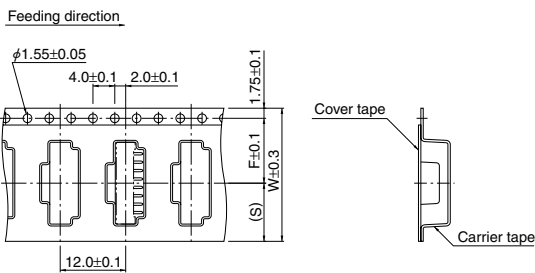

Circuits		Taping dimensions (mm)			Reel dimensions (mm)	Q'ty / reel	
		F	S	W	W1		
SM2 Type	Side entry type	2 to 6	7.5	6.75	16.0	17.5	1,000
		7 to 11	11.5	10.75	24.0	25.5	1,000
		12 to 13	14.2	28.4	32.0	33.5	1,000
SM4 Type	Top entry type	2	5.5	4.75	12.0	13.5	1,000
		3 to 5	7.5	6.75	16.0	17.5	1,000
		6 to 10	11.5	10.75	24.0	25.5	1,000
		11 to 12	14.2	28.4	32.0	33.5	1,000
	Side entry type	13	20.2	40.4	44.0	45.5	1,000
		2 to 5	7.5	6.75	16.0	17.5	1,000
		6 to 10	11.5	10.75	24.0	25.5	1,000
	11 to 12	14.2	28.4	32.0	33.5	1,000	
	13	20.2	40.4	44.0	45.5	1,000	

**Note:**

- Specifications conform to JIS C 0806. The tape width, connector recess dimensions, etc. are determined by the number of circuits and external shape of the connector to be loaded.
- Specifications are subject to change without prior notice.