

NOTES

- 製品詳細寸法については、SD-502494-002を参照下さい。
PLEASE REFER TO SD-502494-002 FOR THE DETAILED DIMENSION OF THE CONNECTOR.
- 梱包数量：950個
NUMBER OF CONNECTIONS：950 PIECES/REEL.
- リードテープ長さ
LEAD TAPE LENGTH

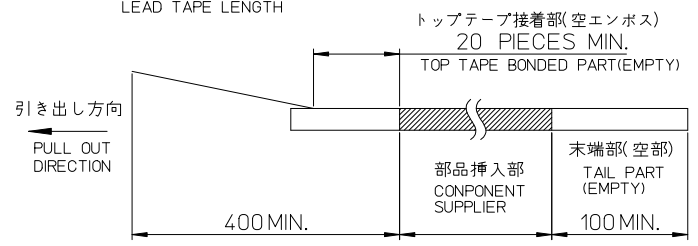

- 材料
MATERIAL
キャリアテープ：ポリスチレン
CARRIER TAPE：POLYSTYRENE
トップテープ：ポリエチレン、ポリエチレンテレフタレート
TOP TAPE：POLYESTER、POLYETHYLENE、POLYETHYLENE TEREPHTHALATE
リール：ポリスチレン <リサイクル材を含む>
REEL：POLYSTYRENE <RECYCLE MATERIAL CONTAINED>
- ELV及びRoHS適合品
ELV AND RoHS COMPLIANT

57.5	26.2	56	502494-1570	15
57.5	26.2	56	502494-1470	14
45.5	20.2	44	502494-1370	13
45.5	20.2	44	502494-1270	12
45.5	20.2	44	502494-1070	10
45.5	20.2	44	502494-0870	8
33.5	14.2	32	502494-0670	6
25.5	11.5	24	502494-0470	4
C	B	エンボステープ幅 WIDTH OF TAPE	製品番号 MATERIAL NO.	極数 CXT. NO.

REVISED EC NO: J2011-0559 DRWN: HOBAYASHI 2010/08/30 CHKD: SAKIYAMA 2010/12/27 APPR: NUKITA 2010/12/27	DESCRIPTION	GENERAL TOLERANCES (UNLESS SPECIFIED)		DIMENSION STYLE MM ONLY		SCALE ---	DESIGN UNITS METRIC		THIRD ANGLE PROJECTION	
		10 UNDER	±0.2	DRAWN BY NITO	DATE 2007/01/11	TITLE EMBOSSSED TAPE PACKAGE FOR 502494				
		10 OVER 30 UNDER	±0.25	CHECKED BY KASAKAWA	DATE 2007/01/11	MOLEX INCORPORATED				
		30 OVER	±0.3	APPROVED BY YOITO	DATE 2007/01/11					
REV	DESCRIPTION	ANGULAR ±3 ° DRAFT WHERE APPLICABLE MUST REMAIN WITHIN DIMENSIONS		MATERIAL NO. SEE TABLE		DOCUMENT NO. SD-502494-001		SHEET NO. 1 OF 1		

NOTES

1. 嵌合相手 : 502439-**00
MATE WITH : 502439-**00
2. 端子テール部 及び ネイルの平坦度 : 0.1MAX.
TAIL AND NAIL COPLANARITY TO BE 0.1 MAX.
3. 極数 / 2 = 偶数に適用。
APPLY FOR CKT. SIZE / 2 = EVEN.
4. 端子テール部 及び ネイルに錫めっきを使用しているため、
外観に摺動痕が付く場合が御座います。
THE WOUND OF FRICTION MIGHT ADHERE TO EXTERNALS
BECAUSE THE TIN PLATING IS USED FOR THE TAIL AND NAIL.
5. 本製品のプラスチック部に黒点等が確認される場合や
色合いが異なる場合がありますが、製品性能に影響はありません。
THERE IS NO INFLUENCE IN THE PRODUCT PERFORMANCE THOUGH
THE BLACK SPOT ETC. MIGHT BE CONFIRMED TO THE PLASTIC PART
OF THIS PRODUCT AND THE SHADE MIGHT BE DIFFERENT.
6. ELV 及び RoHS 適合品
ELV AND RoHS COMPLIANT

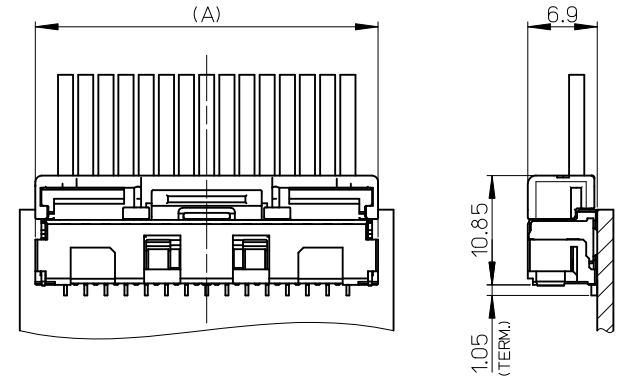
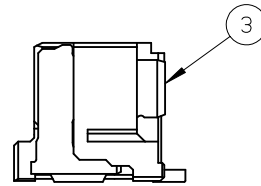
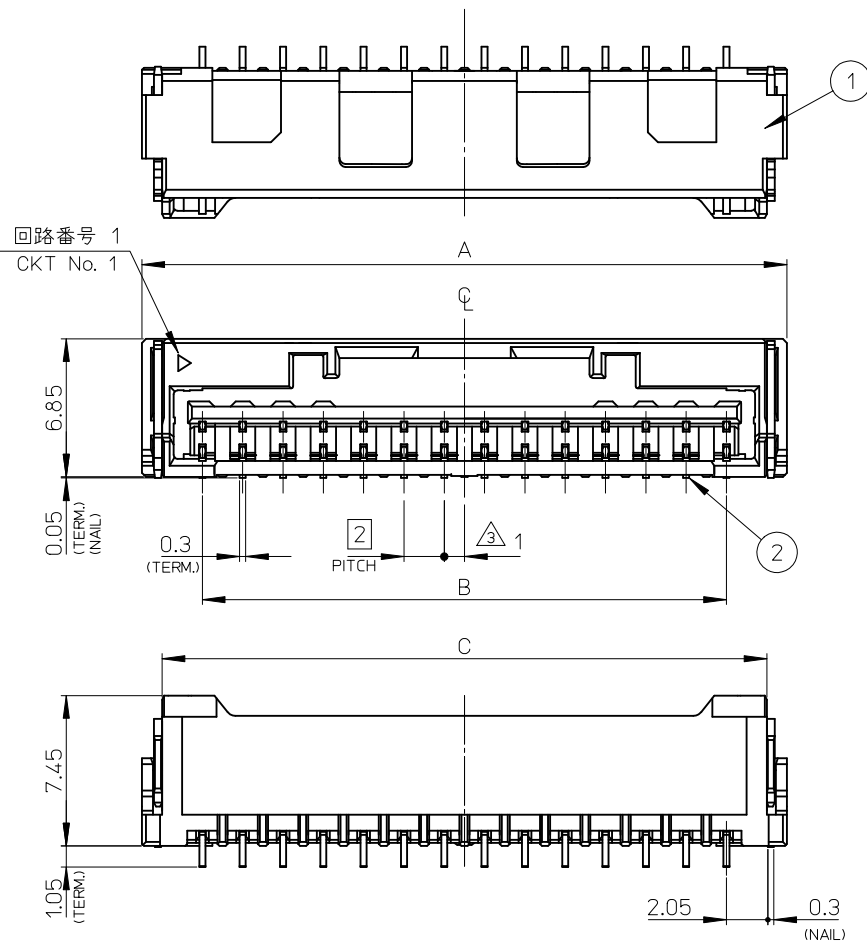

嵌合図 MATED CONNECTORS
(SCALE : 2-1)

9.2	32	28	34	502494-1570	15
5.2	30	26	32	502494-1470	14
5.2	28	24	30	502494-1370	13
5.2	26	22	28	502494-1270	12
5.2	22	18	24	502494-1070	10
5.2	18	14	20	502494-0870	8
4	14	10	16	502494-0670	6
7.6	10	6	12	502494-0470	4
D	C	B	A	EMBOSSED TAPE PACKAGE	極数
				注文番号 ORDER No.	CKT. NO.

番号 NO.	部品 PART	材質 MATERIAL
①	ハウジング HOUSING	耐熱性樹脂 UL94V-0 色 : ナチュラル HEATPROOF RESIN UL94V-0 COLOR:NATURAL
②	ターミナル TERMINAL	銅合金 COPPER ALLOY 錫めっき : 1.0 micro-meter MIN. TIN (TAIL AREA) ニッケルめっき(下地) : 1.0 micro-meter MIN. NICKEL (UNDER PLATING)
③	ネイル NAIL	銅合金 COPPER ALLOY 錫めっき : 1.0 micro-meter MIN. TIN ニッケルめっき(下地) : 1.0 micro-meter MIN. NICKEL (UNDER PLATING)

REVISED EC NO. J2012-0012 DRW:NITO 2011/07/19 CHKD:SAKIYAMA 2011/07/19 APPR:NUKITA 2011/07/20	DESCRIPTION	GENERAL TOLERANCES (UNLESS SPECIFIED)		DIMENSION STYLE MM ONLY		SCALE 4:1	DESIGN UNITS METRIC	THIRD ANGLE PROJECTION	
		10 UNDER	±0.2	DRAWN BY NITO	DATE 2007/01/11	TITLE 2.0 W/B CONN. SINGLE R/A REC. ASSY 2-15CKT -LEAD FREE-			
		10 OVER 30 UNDER	±0.25	CHECKED BY KASAKAWA	DATE 2007/01/11	MOLEX INCORPORATED			
		30 OVER	±0.3	APPROVED BY YOITO	DATE 2007/01/11				
REV		ANGULAR ±1 ° DRAFT WHERE APPLICABLE MUST REMAIN WITHIN DIMENSIONS		SIZE A3	THIS DRAWING CONTAINS INFORMATION THAT IS PROPRIETARY TO MOLEX INCORPORATED AND SHOULD NOT BE USED WITHOUT WRITTEN PERMISSION				

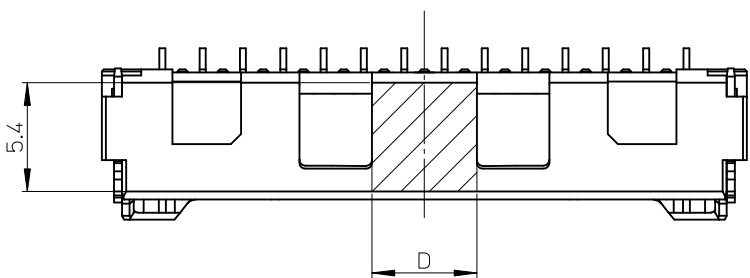

吸着エリア 6~15極
VACUME AREA 6~15CKT

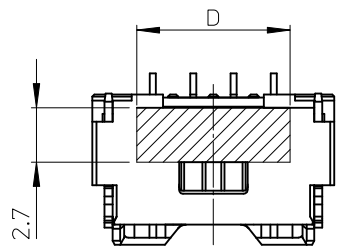

吸着エリア 4極
VACUME AREA 4CKT

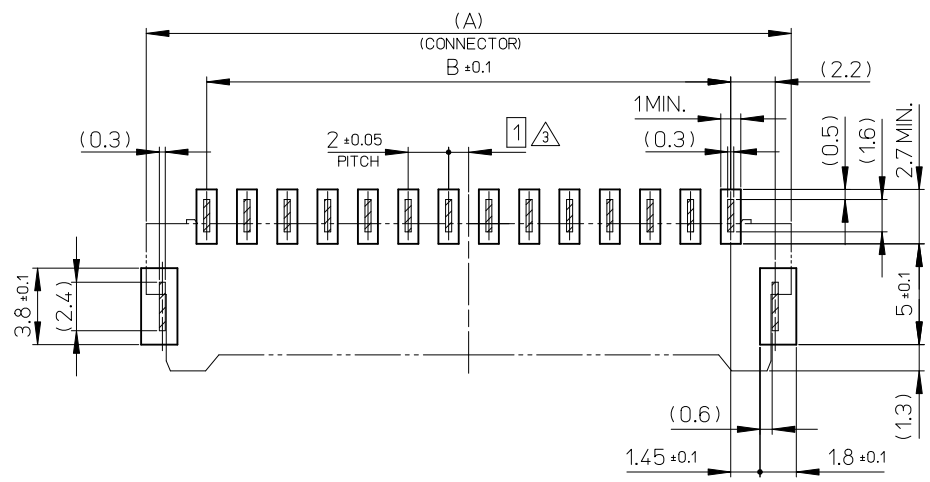

基板パターンレイアウト(参考)
RECCOMENDED P.C.B. PATTERN LAYOUT (REF.)

REVISED EC NO: J2012-0012 DRWN:NITO 2011/07/19 CHKD:SAKIYAMA 2011/07/19 APPR:NUKITA 2011/07/20	GENERAL TOLERANCES (UNLESS SPECIFIED)		DIMENSION STYLE MM ONLY	SCALE 4:1	DESIGN UNITS METRIC	THIRD ANGLE PROJECTION
	10 UNDER	±0.2	DRAWN BY NITO	DATE 2007/01/11	TITLE 2.0 W/B CONN. SINGLE R/A REC. ASSY 2-15CKT	
	10 OVER 30 UNDER	±0.25	CHECKED BY KASAKAWA	DATE 2007/01/11	MOLEX INCORPORATED	
	30 OVER	±0.3	APPROVED BY YOITO	DATE 2007/01/11	MATERIAL NO. SEE TABLE	DOCUMENT NO. SD-502494-002
	ANGULAR ±1 °	DRAFT WHERE APPLICABLE MUST REMAIN WITHIN DIMENSIONS	SIZE A3	THIS DRAWING CONTAINS INFORMATION THAT IS PROPRIETARY TO MOLEX INCORPORATED AND SHOULD NOT BE USED WITHOUT WRITTEN PERMISSION		