

Features

- Ideal for PHS Applications
- Linear Output Power: +24 dBm Typical @ 3.6 V
- Small Signal Gain: 36 dB Typical
- Low Current: 200 mA at +21 dBm Pout
- Passes 1KV ESD rating
- Micro-Amp Shutdown
- Operates from 2.8 V to 4.2 V
- Lead-Free 3 mm, 12-Lead PQFN Package
- 100% Matte Tin Plating over Copper
- Halogen-Free “Green” Mold Compound
- RoHS* Compliant and 260°C Reflow Compatible

Description

The MAAP-000082 is a three stage power amplifier designed for PHS applications. This power amplifier is packaged in a lead-free standard outline 3 mm, 12-lead PQFN plastic package.

Functional Block Diagram

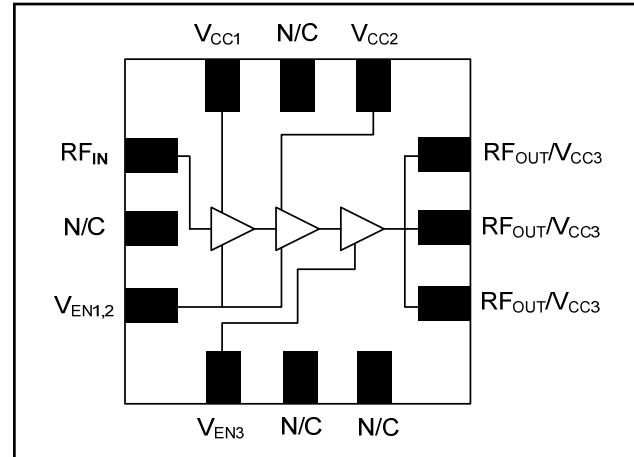

Ordering Information^{1,2}

Part Number	Package
MAAP-000082-TR3000	3000 piece reel
MAAP-000082-001SMB	Sample Test Board 1880 - 1930 MHz Tuning

1. Reference Application Note M513 for reel size information.
2. All sample boards include 5 loose parts.

Absolute Maximum Ratings^{3,4}

Parameter	Absolute Maximum
Input Power	0 dBm
Operating Supply Voltage	+4.2 Volts
Operating Control Voltage	+3.0 Volts
Operating Temperature	-40°C to +85°C
Channel Temperature	+150 °C
Storage Temperature	-50°C to +150°C

3. Exceeding any one or combination of these limits may cause permanent damage to this device.
4. M/A-COM does not recommend sustained operation near these survivability limits.

Pin Configuration

Pin No.	Pin Name	Description
1	RF _{IN}	RF Input
2	N/C	No Connection
3	V _{EN1,2}	Power Enable
4	V _{EN3}	Power Enable
5	N/C	No Connection
6	N/C	No Connection
7	RF _{OUT} / V _{CC3}	RF Output, 3rd Stage Supply
8	RF _{OUT} / V _{CC3}	RF Output, 3rd Stage Supply
9	RF _{OUT} / V _{CC3}	RF Output, 3rd Stage Supply
10	V _{CC2}	2nd Stage Supply
11	N/C	No Connection
12	V _{CC1}	1st Stage Supply
Pad ⁵	GND	RF & DC Ground

5. The exposed pad centered on the package bottom must be connected to RF and DC ground.

* Restrictions on Hazardous Substances, European Union Directive 2002/95/EC.

Electrical Specifications: F = 1905 MHz, T_A = +25 °C, V_{CC} = 3.6 V, V_{EN} = 3.0 V, Z_O = 50 Ω

Parameter	Test Conditions	Units	Min.	Typ.	Max.
Gain	P _{OUT} = +21 dBm	dB	34	36	38
Input Return Loss	—	dB	—	15	—
ACPR	P _{OUT} = +21 dBm, 600 KHz offset	dBc	—	-63	-60
	P _{OUT} = +24 dBm, 600 KHz offset	dBc	—	-60	—
ALT	P _{OUT} = +21 dBm, 900 KHz offset	dBc	—	-72	-69
	P _{OUT} = +24 dBm, 900 KHz offset	dBc	—	-70	—
P1dB	—	dBm	—	26.5	—
PAE	P _{OUT} = +21 dBm	%	—	17	—
	P _{OUT} = +24 dBm	%	—	25	—
Operating Current	P _{OUT} = +21 dBm	mA	—	200	240
	P _{OUT} = +24 dBm	mA	—	280	—
Idle Current	No RF applied	mA	—	90	150
Current, Off	V _{EN} = 0 V	μA	—	3	—
Enable Current	V _{EN} = 3.0 V	mA	—	4	—
Forward Isolation	V _{EN} = 0 V	dB	—	39	—
Stability	P _{OUT} < 27 dBm, VSWR < 4:1 -20°C < T _A < +70°C		All spurs < -60 dBc		

Handling Procedures

Please observe the following precautions to avoid damage:

Static Sensitivity

Silicon germanium Integrated Circuits are sensitive to electrostatic discharge (ESD) and can be damaged by static electricity. Proper ESD control techniques should be used when handling these devices.

Recommended PCB Configuration

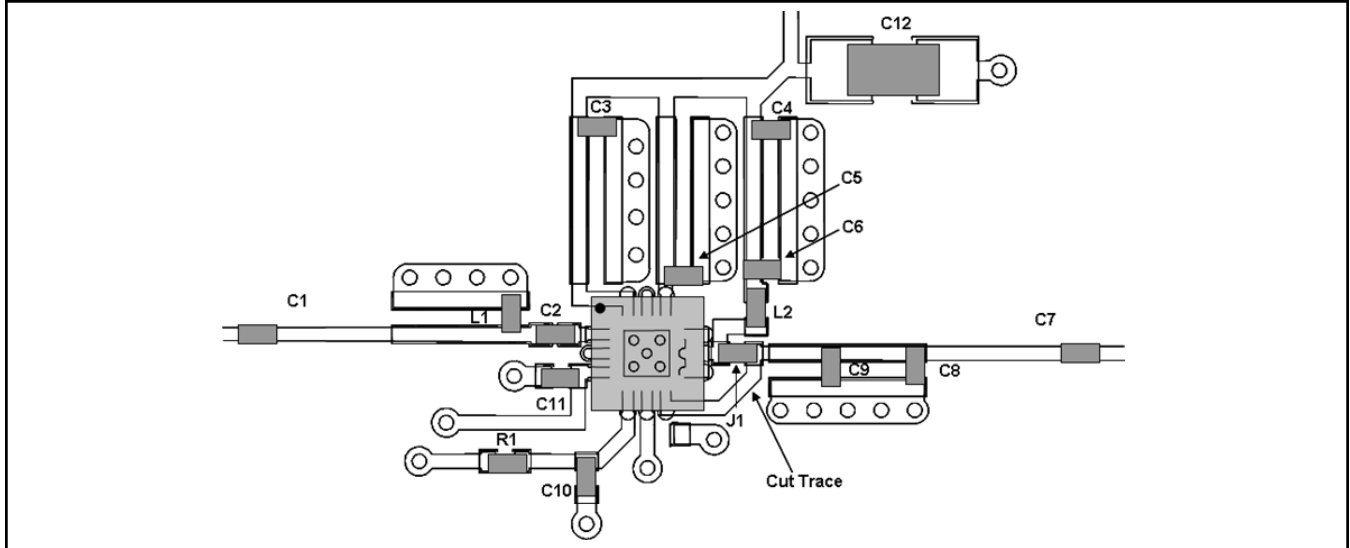

Schematic

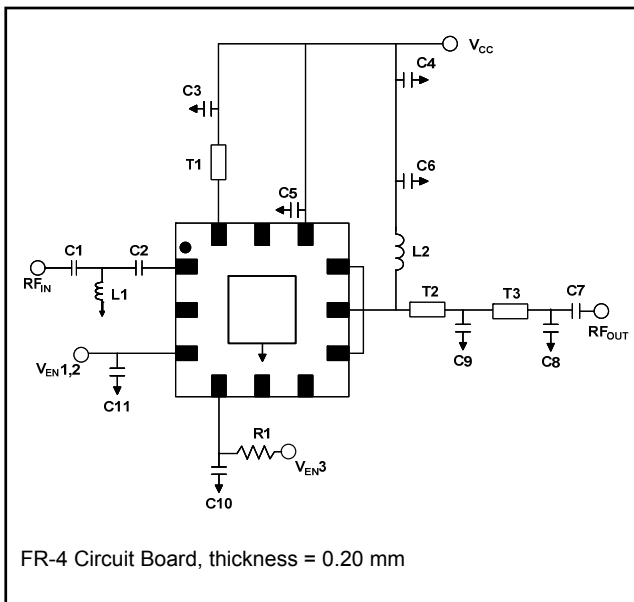

External Parts List

Designator	Value	Foot Print	Manufacturer
C1	1000 pF	0402	Murata
C2	18 pF	0402	Murata
C3, C4, C5, C10, C11	0.1 μ F	0402	Murata
C6	15 pF	0402	Murata
C7	47 pF	0402	Murata
C8	0.5 pF	0402	Murata
C9	2.7 pF	0402	Murata
L1	2.2 nH	0402	Coilcraft
L2	15 nH	0402	Coilcraft
R1	820 Ω	0402	Panasonic

Frequency = 1905 MHz		
	Impedance	Electrical Length (mils)
T1	50 Ω	200
T2	50 Ω	120
T3	50 Ω	70

Typical Characteristics @ +25°C, -40°C, +85°C, +60°C, -10°C, V_{CC} = 3.6 V

Gain vs. P_{OUT} @ 1905 MHz

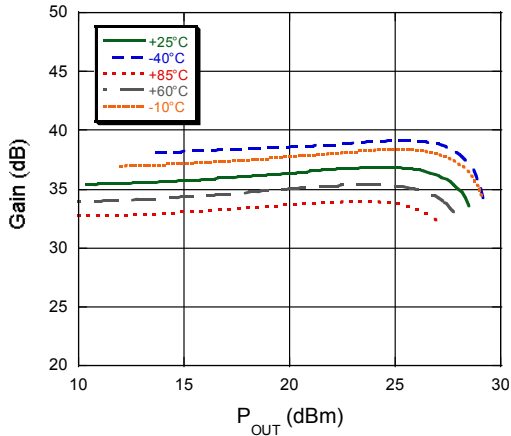

PAE vs. P_{OUT} @ 1905 MHz

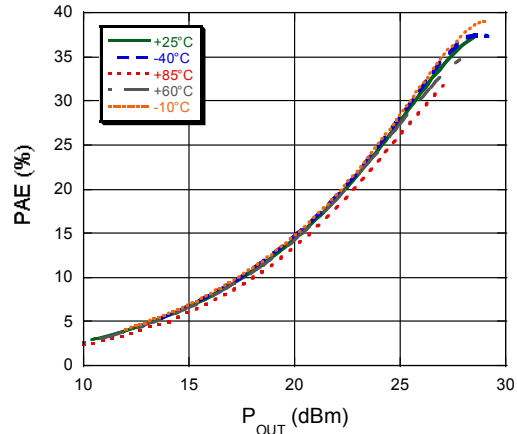

ACPR vs. P_{OUT} @ 1905 MHz

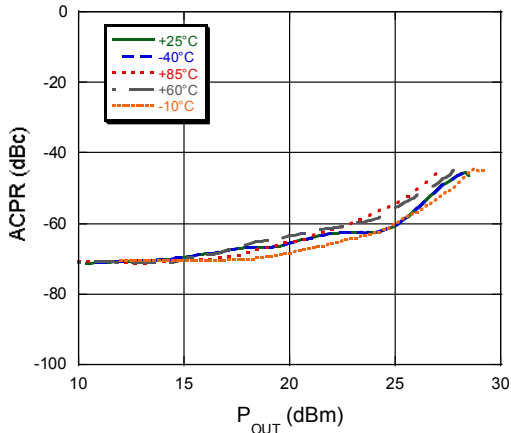

ALT vs. P_{OUT} @ 1905 MHz

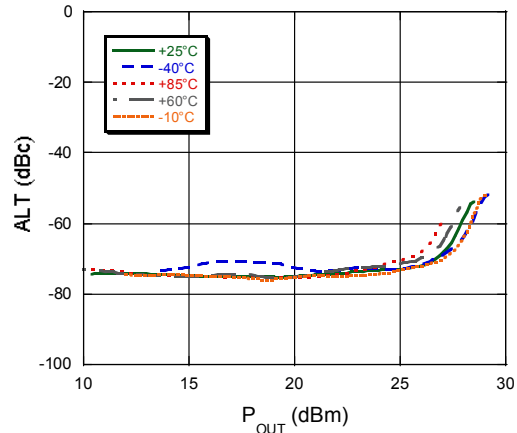

I_{CC} vs. P_{OUT} @ 1905 MHz

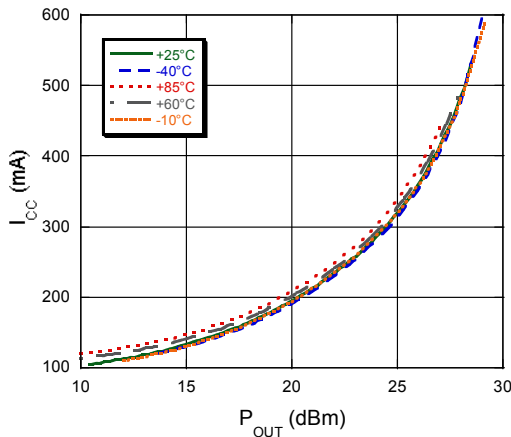

Typical Performance Curves, 1905 MHz, V_{CC} swept from 3.4 V to 4.2 V by 0.2 steps

Gain vs. P_{OUT}

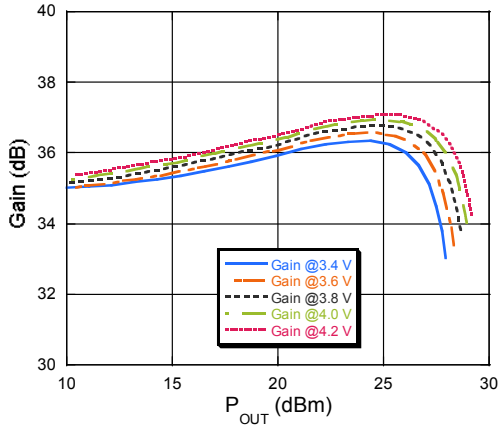

PAE vs. P_{OUT}

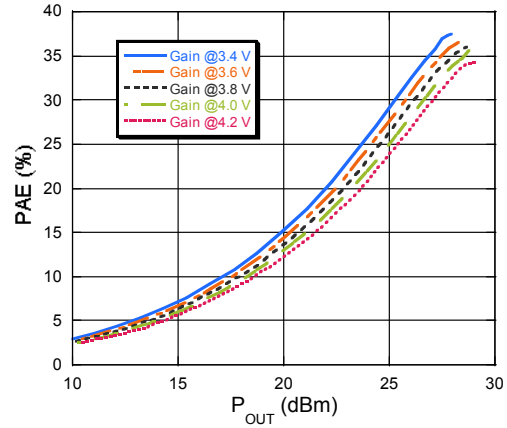

ACPR vs. P_{OUT}

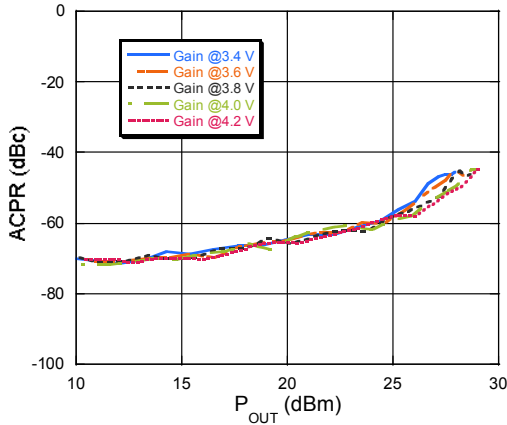

ALT vs. P_{OUT}

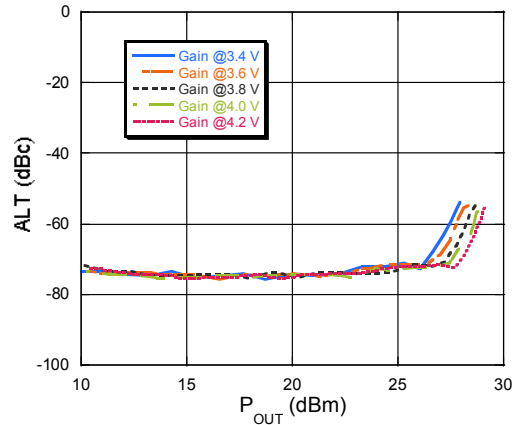

I_{CC} vs. P_{OUT}

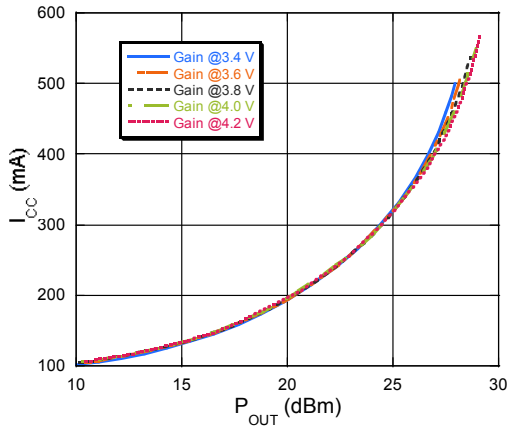

Lead-Free 3 mm 12-Lead PQFN†

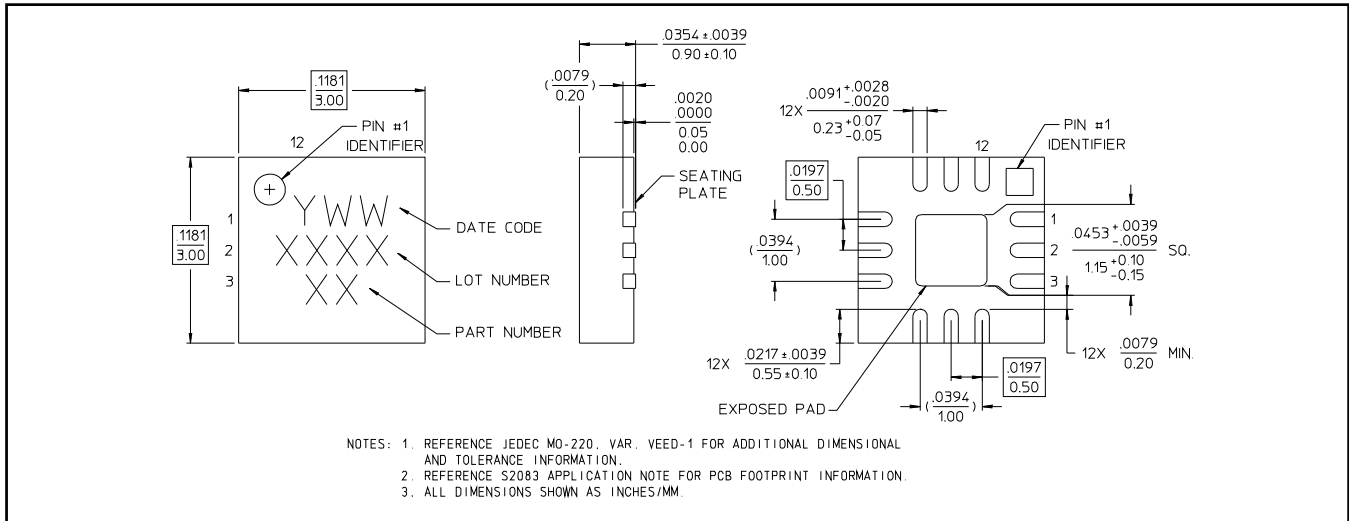

† Reference Application Note M538 for lead-free solder reflow recommendations.
Meets JEDEC moisture sensitivity level 1 requirements.