

#### Features

- Glass Passivated Die Construction
- Low Forward Voltage Drop
- High Current Capability
- High Reliability
- High Surge Current Capability

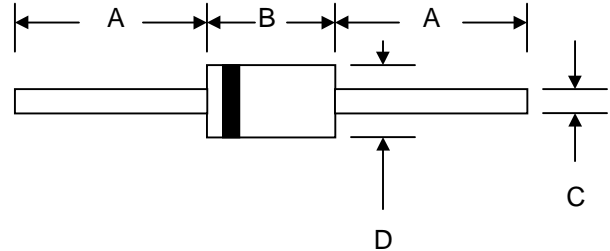

#### Mechanical Data

- Case: DO-201AD, Molded Plastic
- Terminals: Plated Leads Solderable per MIL-STD-202, Method 208
- Polarity: Cathode Band
- Weight: 1.2 grams (approx.)
- Mounting Position: Any
- Marking: Type Number
- **Lead Free: For RoHS / Lead Free Version**

DO-201AD		
Dim	Min	Max
A	24.5	—
B	7.20	9.50
C	1.10	1.30
D	5.00	5.60
All Dimensions in mm		

#### Maximum Ratings and Electrical Characteristics @ $T_A=25^\circ\text{C}$ unless otherwise specified

Single Phase, half wave, 60Hz, resistive or inductive load.  
For capacitive load, derate current by 20%.

Characteristic	Symbol	HER 501G	HER 502G	HER 503G	HER 504G	HER 505G	HER 506G	HER 507G	HER 508G	Unit	
Peak Repetitive Reverse Voltage	$V_{RRM}$	50	100	200	300	400	600	800	1000	V	
Working Peak Reverse Voltage	$V_{RWM}$										
DC Blocking Voltage	$V_R$										
RMS Reverse Voltage	$V_{R(RMS)}$	35	70	140	210	280	420	560	700	V	
Average Rectified Output Current (Note 1)	$I_O$	5.0								A	
Non-Repetitive Peak Forward Surge Current 8.3ms Single half sine-wave superimposed on rated load (JEDEC Method)	$I_{FSM}$	150								A	
Forward Voltage @ $I_F = 5.0A$	$V_{FM}$	1.0			1.3		1.7			V	
Peak Reverse Current @ $T_A = 25^\circ\text{C}$ At Rated DC Blocking Voltage @ $T_A = 100^\circ\text{C}$	$I_{RM}$	10				100				$\mu A$	
Reverse Recovery Time (Note 2)	$t_{rr}$	50					75				nS
Typical Junction Capacitance (Note 3)	$C_j$	80					50				pF
Operating Temperature Range	$T_j$	-65 to +150								$^\circ\text{C}$	
Storage Temperature Range	$T_{STG}$	-65 to +150								$^\circ\text{C}$	

Note: 1. Leads maintained at ambient temperature at a distance of 9.5mm from the case  
2. Measured with  $I_F = 0.5A$ ,  $I_R = 1.0A$ ,  $IRR = 0.25A$ . See figure 5.  
3. Measured at 1.0 MHz and applied reverse voltage of 4.0V D.C.

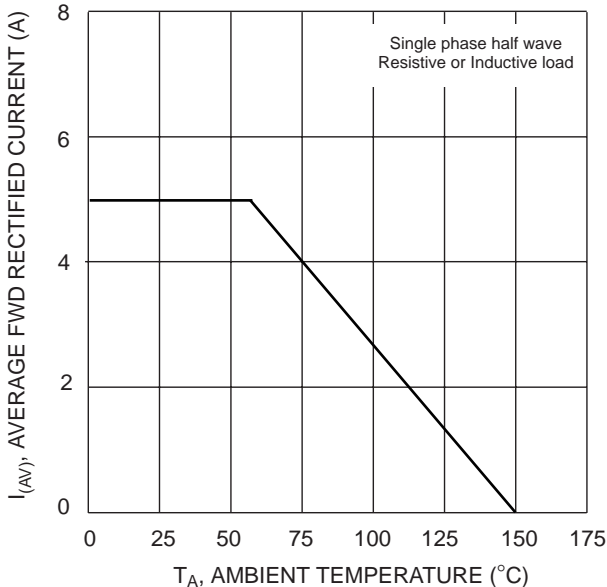

Fig. 1 Forward Current Derating Curve

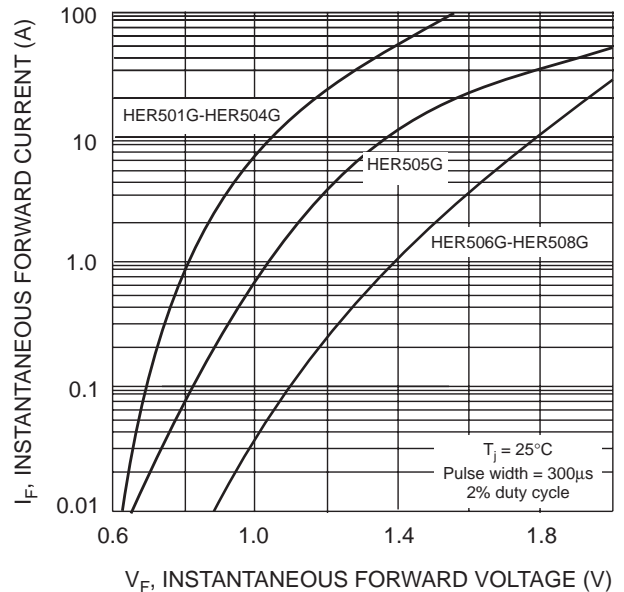

Fig. 2 Typical Forward Characteristics

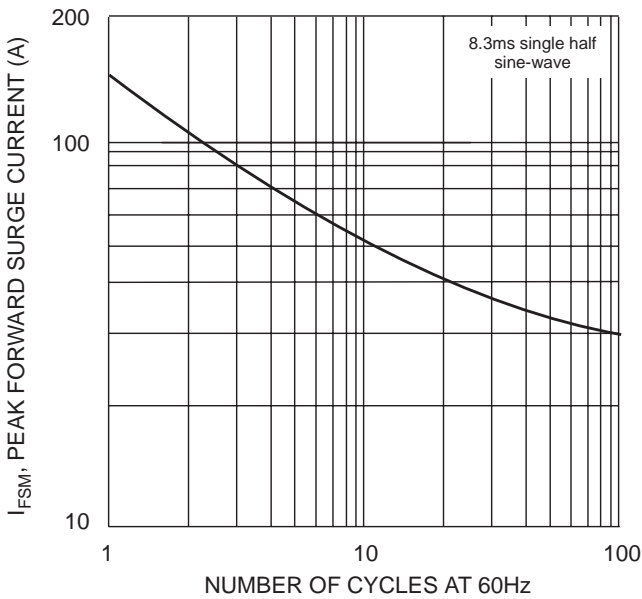

Fig. 3 Peak Forward Surge Current

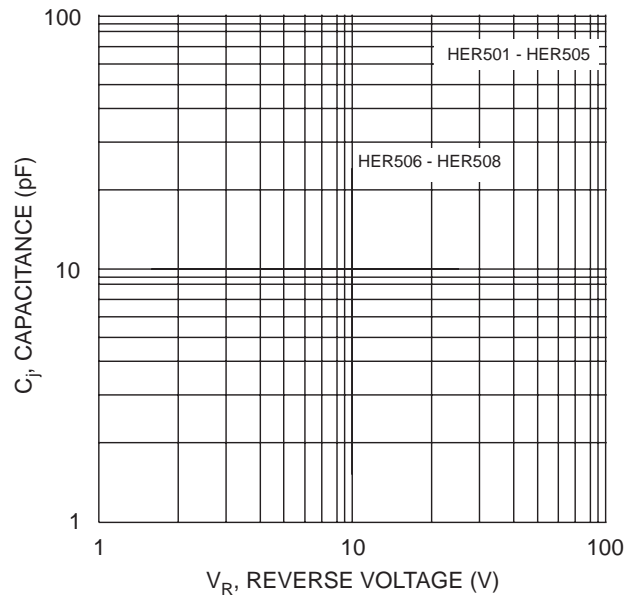
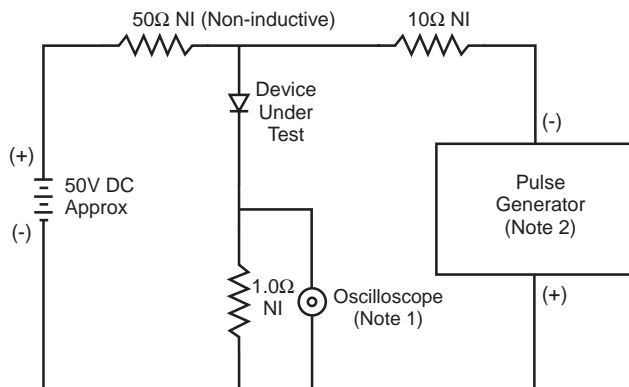
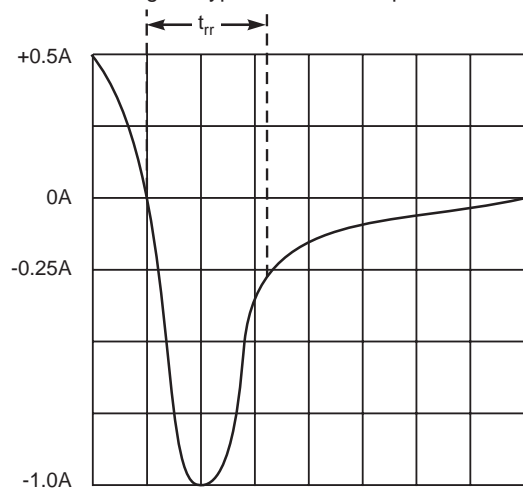

Fig. 4 Typical Junction Capacitance



Notes:

1. Rise Time = 7.0ns max. Input Impedance = 1.0MΩ, 22pF.
2. Rise Time = 10ns max. Input Impedance = 50Ω.



Set time base for 5/10ns/cm

Fig. 5 Reverse Recovery Time Characteristic and Test Circuit