



**C-BAND
POWER GaAs MESFET**

**NEZ
C-BAND
SERIES**

FEATURES

- INTERNALLY MATCHED (IN/OUT)
- HIGH P_{OUT} (4 W, 8 W, & 15 W)
- CLASS A OPERATION
- HIGH η_{ADD} (40% TYP)
- LOW IM₃ (-45 dBc TYP)
- HERMETICALLY SEALED METAL/CERAMIC PACKAGE
- SPACE QUALIFIED

APPLICATIONS

- ANALOG COMMUNICATIONS
- DIGITAL COMMUNICATIONS

DESCRIPTION

The NEZ C-Band series of high performance microwave power GaAs MESFETs provides high gain and low intermodulation distortion over standard and digital communication bands from 3 to 8 GHz.

Internal input and output thin film matching circuits are designed to optimize performance in 50 Ω external circuits. The NEZ series active devices use a 0.8 μm gate length for increased linear gain. NEC's Plated Heat Sink (PHS) technology reduces thermal resistance and enhances electrical performance. The gate structure is fabricated using WSi (tungsten silicide) for increased ruggedness and reliability. The devices feature TiAu plus plated Au bonding pads, and a combination of SiO₂/SiN₃ is used for scratch protection and surface stability.

As always, NEC's stringent quality assurance and test procedures assure the highest reliability and consistent performances. This series of internally matched power FETs is space qualified.

OUTLINE DIMENSIONS (Units in mm)

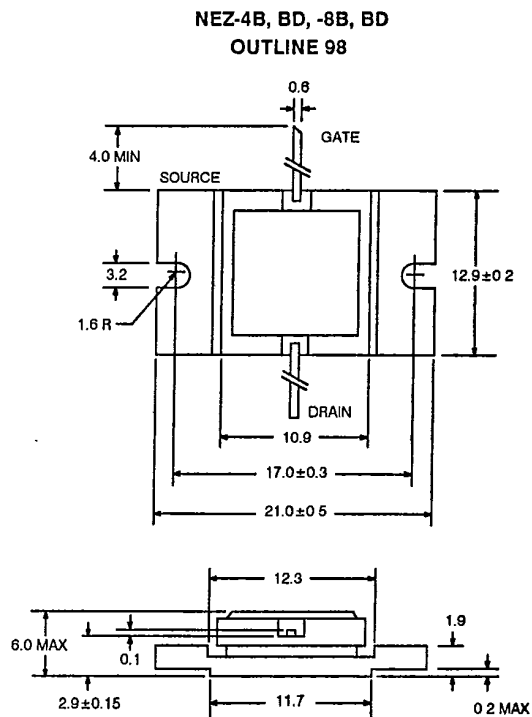
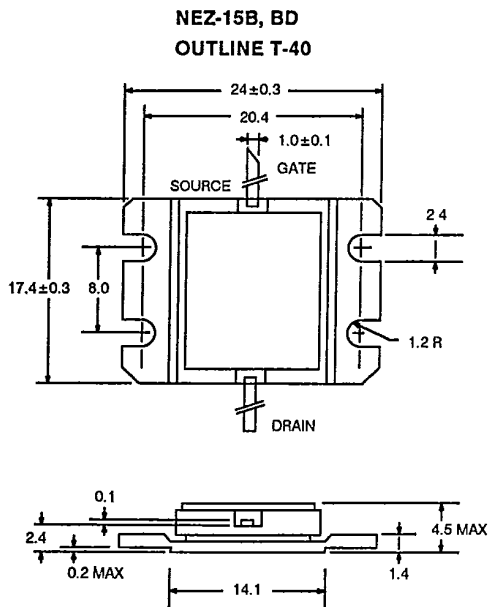

ABSOLUTE MAXIMUM RATINGS (TA = 25°C)

PART NUMBER			NEZ-4B, 4BD	NEZ-8B, 8BD	NEZ-15B, 15BD
SYMBOLS	PARAMETERS	UNITS	RATINGS	RATINGS	RATINGS
Vds	Drain to Source Voltage	V	15	15	15
Vgd	Gate to Drain Voltage	V	-18	-18	-18
Vgs	Gate to Source Voltage	V	-7	-7	-7
Id	Drain Current	A	4.5	7.5	15
Ig	Gate Current	mA	25	50	100
Tch	Channel Temperature	°C	+175	+175	+175
Tsta	Storage Temperature	°C	-65 to +175	-65 to +175	-65 to +175
Pr	Total Power Dissipation, Tcase = +25°C	W	25	50	100

ELECTRICAL CHARACTERISTICS (TA = 25°C)

PART NUMBER PACKAGE OUTLINE			NEZ-4B, 4BD 98			NEZ-8B, 8BD 98			NEZ-15B, 15BD T-40		
SYMBOLS	PARAMETERS AND CONDITIONS	UNITS	MIN	TYP	MAX	MIN	TYP	MAX	MIN	TYP	MAX
I _{DSS}	Saturated Drain Current, V _{ds} = 2.5 V, V _{gs} = 0	A	2.0	3.0	4.5	4.0	5.5	7.5	8	11	15
V _P	Pinch-off Voltage, V _{ds} = 2.5 V, I _d = 14 mA V _{ds} = 2.5 V, I _d = 25 mA V _{ds} = 2.5 V, I _d = 50 mA	V	-4.0	-2.5	-1.5	-5.0	-3.5	-1.5	-5.0	-3.5	-1.5
g _m	Transconductance, V _{ds} = 2.5 V, I _d = 1 A V _{ds} = 2.5 V, I _d = 2 A V _{ds} = 2.5 V, I _d = 4 A	mS mS mS		1000			2000			4000	
R _{th}	Thermal Resistance, Channel to Case (T _{ch} = +125°C)	°C/W		5	6		2.4	3		1.2	1.5



TYPICAL DEVICE CHARACTERISTICS (TA = 25°C)

THIRD ORDER INTERMODULATION vs. OUTPUT POWER

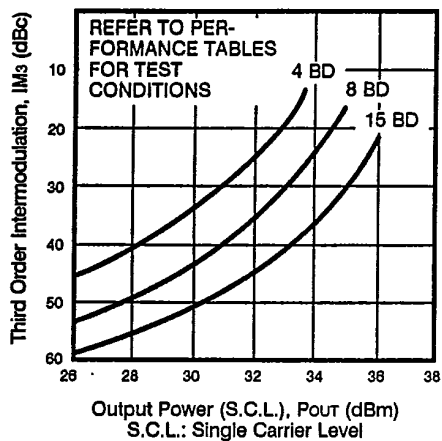

TOTAL POWER DISSIPATION, Prtot (W)

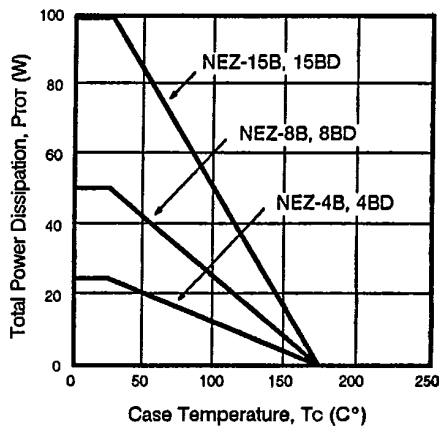

4 W PERFORMANCE SPECIFICATIONS (TA = 25°C)

PART NUMBERS	P _{1dB} ^{2,3,7} (dBm)		G _L ⁷ (dB)		η _{ADD} ² (%)	I _{DS} ³ (A)		FREQ. RANGE (GHz)	IM ₃ ⁴ (dBm)		P _{IN} ⁵ (dBm)	P _{OUT} ⁷ (dBm)	TEST FREQ. ⁶ (GHz)
	MIN	TYP	MIN	TYP	TYP	MIN	TYP		MIN	TYP			
NEZ3742-4B, 4BD	35.5	36.5	10	11	40	1.1	1.5	3.7-4.2	-42	-45	27	37	4.2
NEZ4450-4B	35.5	36.5	9.5	10	39	1.1	1.5	4.4-5.0	-	-	28	37	5.0
NEZ5258-4B	35.5	36.5	9	9.5	38	1.1	1.5	5.2-5.8	-	-	28	37	5.8
NEZ5964-4B, 4BD	35.5	36.5	9	9.5	38	1.1	1.5	5.9-6.4	-42	-45	29	37	6.4
NEZ6472-4B, 4BD	35.5	36.5	8	8.5	36	1.1	1.5	6.4-7.2	-42	-45	29	37	7.2
NEZ7177-4B	35.5	36.5	7.5	8	34	1.1	1.5	7.1-7.7	-	-	29.5	37	7.7
NEZ7784-4B	35.5	36.5	7	7.5	33	1.1	1.5	7.7-8.4	-	-	30	37	8.4

Notes:

- V_{DS} = +10 V for all test conditions.
- I_{DS}, I_{GS}, η_{ADD}, values are specified at P_{1dB} point.
- I_{GS} = 6 mA max with R_G = 100 Ω.
- Specified for NEZ-4BD, Δf = 10 MHz, 2 Tone Test, P_o = 26 dBm S.C.L. (Single Carrier Level).
- Condition for P_{OUT}.
- Condition for P_{OUT}, IM₃.
- I_{DS} = 1 A (RF OFF). Z_S = Z_L = 50 Ω.

8 W PERFORMANCE SPECIFICATIONS (TA = 25°C)

PART NUMBERS	P _{1dB} ^{2,3,7} (dBm)		G _L ⁷ (dB)		η _{ADD} ² (%)	I _{DS} ³ (A)		FREQ. RANGE (GHz)	IM ₃ ⁴ (dBm)		P _{IN} ⁵ (dBm)	P _{OUT} ⁷ (dBm)	TEST FREQ. ⁶ (GHz)
	MIN	TYP	MIN	TYP	TYP	MIN	TYP		MIN	TYP			
NEZ3742-8B, 8BD	38.5	39.5	9	10	34	2.3	3	3.7-4.2	-42	-45	32	39.8	4.2
NEZ4450-8B, 8BD	38.5	39.5	8.5	9.5	33	2.3	3	4.4-5.0	-42	-45	32.5	39.8	5.0
NEZ5258-8B, 8BD	38.5	39.5	8	9	33	2.3	3	5.2-5.8	-42	-45	33	39.8	5.8
NEZ5964-8B, 8BD	38.5	39.5	8	9	33	2.3	3	5.9-6.4	-42	-45	33	39.8	6.4
NEZ6472-8B, 8BD	38.5	39.5	7	7.5	30	2.3	3	6.4-7.2	-42	-45	34	39.8	7.2
NEZ7177-8B, 8BD	38.5	39.5	6.5	7	29	2.3	3	7.1-7.7	-42	-45	34.5	39.8	7.7
NEZ7784-8B, 8BD	38.5	39.5	6	6.5	28	2.3	3	7.7-8.4	-42	-45	35	39.8	8.4

Notes:

- V_{DS} = +10 V for all test conditions.
- I_{DS}, I_{GS}, η_{ADD}, values are specified at P_{1dB} point.
- I_{GS} = 10 mA max with R_G = 100 Ω.
- Specified for NEZ-8BD, Δf = 10 MHz, 2 Tone Test, P_o = 29 dBm S.C.L. (Single Carrier Level).
- Condition for P_{OUT}.
- Condition for P_{OUT}, IM₃.
- I_{DS} = 2 A (RF OFF). Z_S = Z_L = 50 Ω.

15 W PERFORMANCE SPECIFICATIONS (TA = 25°C)

PART NUMBERS	P _{1dB} ^{2,3,7} (dBm)		G _L ⁷ (dB)		η _{ADD} ² (%)	I _{DS} ³ (A)		FREQ. RANGE (GHz)	IM ₃ ⁴ (dBm)		P _{IN} ⁵ (dBm)	P _{OUT} ⁷ (dBm)	TEST FREQ. ⁶ (GHz)
	MIN	TYP	MIN	TYP	TYP	MIN	TYP		MIN	TYP			
NEZ3742-15B, 15BD	41.5	42.5	9	10	34	4.5	6	3.7-4.2	-42	-45	35	42.8	4.2
NEZ4450-15B, 15BD	41.5	42.5	8	9	33	4.5	6	4.4-5.0	-42	-45	35.5	42.8	5.0
NEZ5258-15B, 15BD	41.5	42.5	7.5	8.5	33	4.5	6	5.2-5.8	-42	-45	36	42.8	5.8
NEZ5964-15B, 15BD	41.5	42.5	7	8	32	4.5	6	5.9-6.4	-42	-45	36	42.8	6.4
NEZ6472-15B, 15BD	41.5	42.5	6.5	7	30	4.5	6	6.4-7.2	-42	-45	37	42.8	7.2
NEZ7177-15B, 15BD	41.5	42.5	6	6.5	28	4.5	6	7.1-7.7	-42	-45	37.5	42.8	7.7
NEZ7784-15B, 15BD	41.5	42.5	5.5	6	27	4.5	6	7.7-8.4	-42	-45	38	42.8	8.4

Notes:

- V_{DS} = +10 V for all test conditions.
- I_{DS}, I_{GS}, η_{ADD}, values are specified at P_{1dB} point.
- I_{GS} = 20 mA max with R_G = 100 Ω.
- Specified for NEZ-15BD, Δf = 10 MHz, 2 Tone Test, P_o = 32 dBm S.C.L. (Single Carrier Level).
- Condition for P_{OUT}.
- Condition for P_{OUT}, IM₃.
- I_{DS} = 4 A (RF OFF). Z_s = Z_L = 50 Ω.



4 W TYPICAL PERFORMANCE CHARACTERISTICS (TA = 25°C)

NEZ7177-4B
DRAIN CURRENT, OUTPUT POWER,
GATE CURRENT AND EFFICIENCY vs.
INPUT POWER

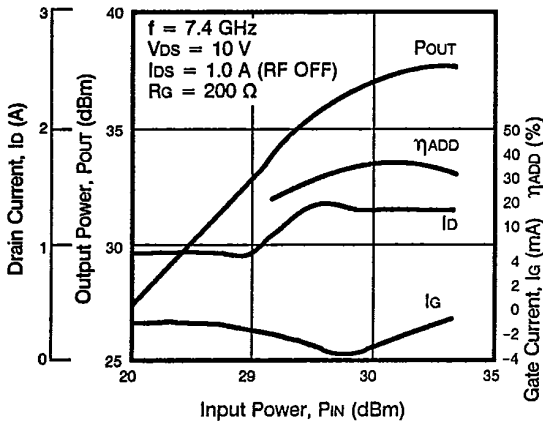

NEZ7784-4B
DRAIN CURRENT, OUTPUT POWER,
GATE CURRENT AND EFFICIENCY vs.
INPUT POWER

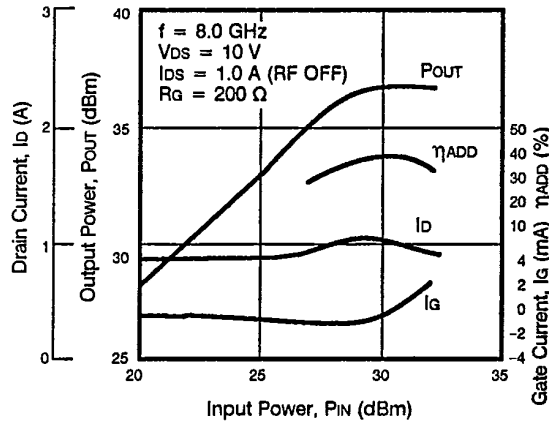

8 W TYPICAL PERFORMANCE CHARACTERISTICS (TA = 25°C)

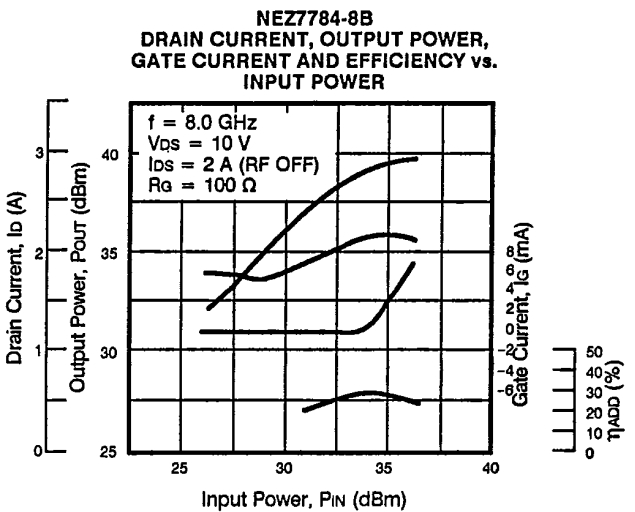
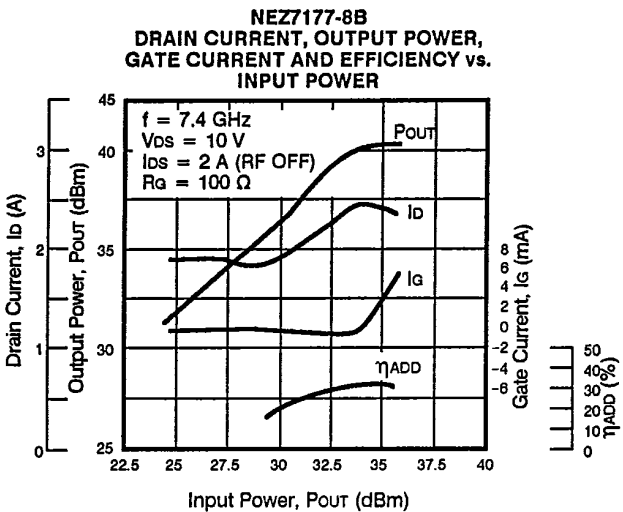
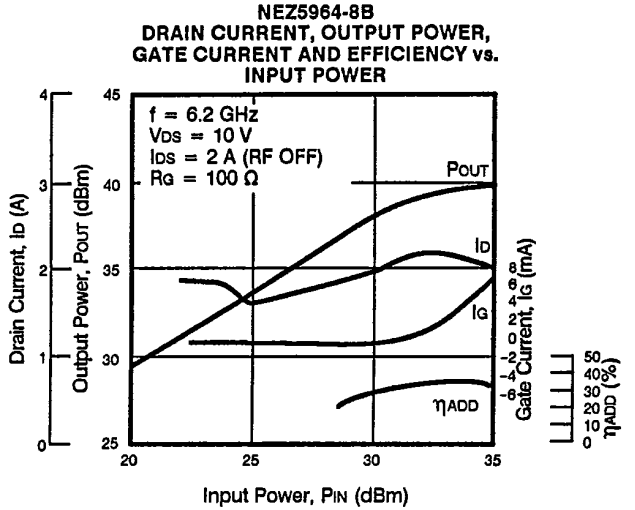
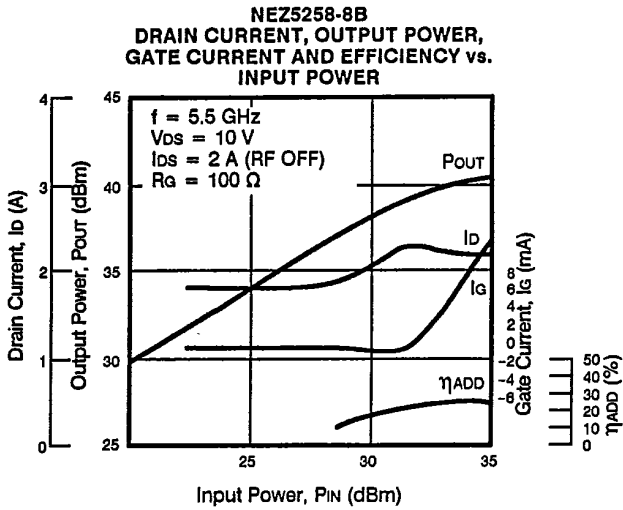
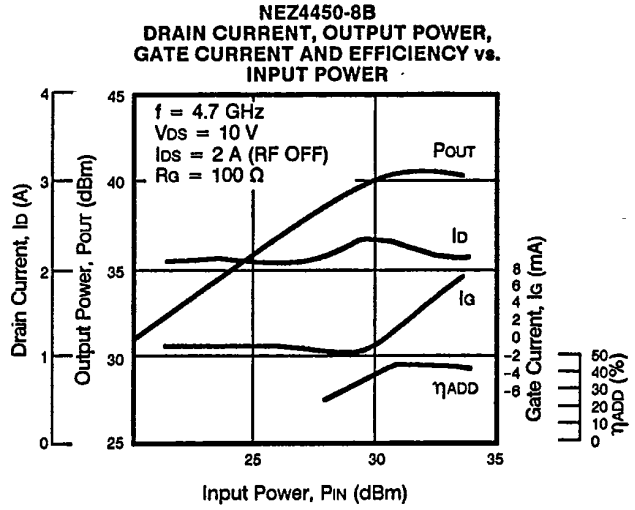
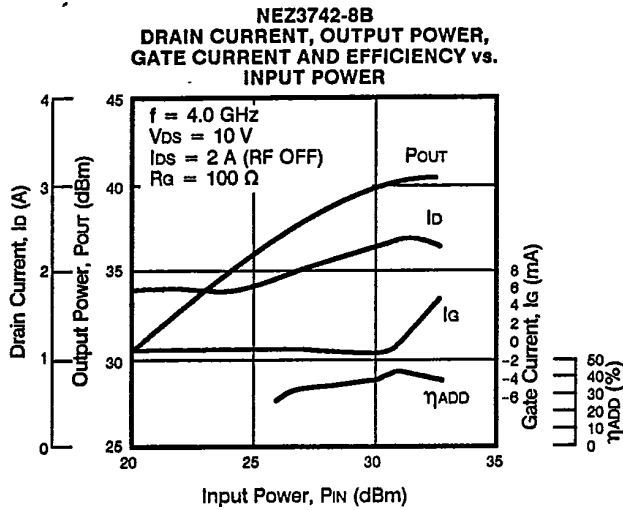

15 W TYPICAL PERFORMANCE CHARACTERISTICS (T_A = 25°C)

NEZ3742-15B
DRAIN CURRENT, OUTPUT POWER,
GATE CURRENT AND EFFICIENCY vs.
INPUT POWER

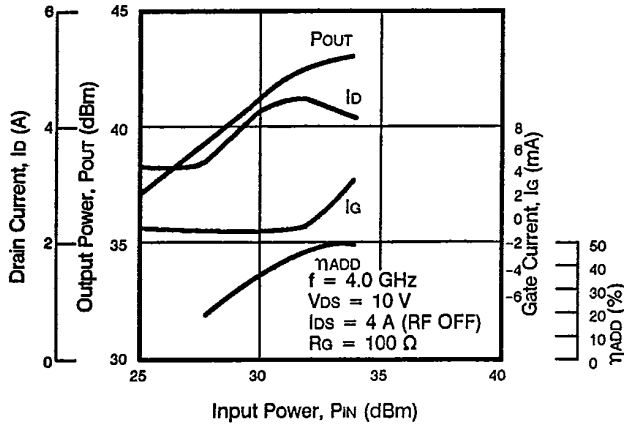

NEZ4450-15B
DRAIN CURRENT, OUTPUT POWER,
GATE CURRENT AND EFFICIENCY vs.
INPUT POWER

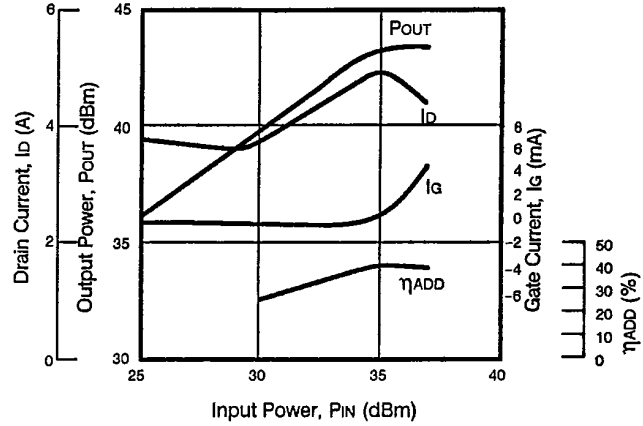

NEZ5258-15B
DRAIN CURRENT, OUTPUT POWER,
GATE CURRENT AND EFFICIENCY vs.
INPUT POWER

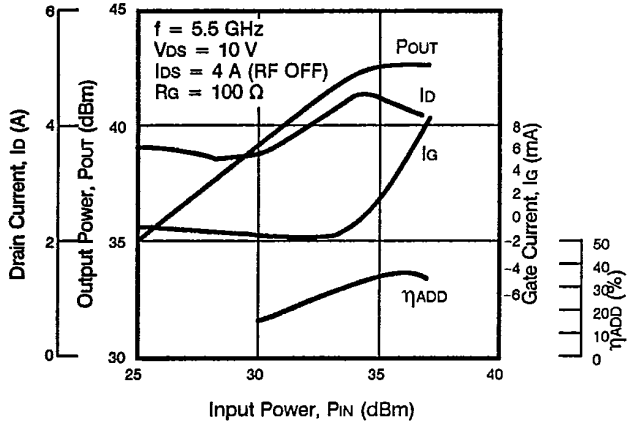

NEZ5964-15B
DRAIN CURRENT, OUTPUT POWER,
GATE CURRENT AND EFFICIENCY vs.
INPUT POWER

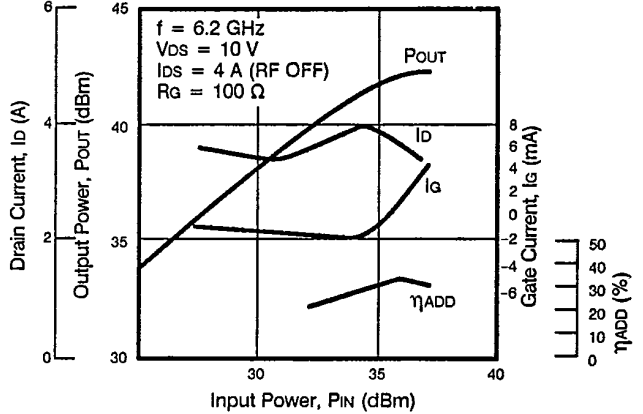

NEZ6472-15B
DRAIN CURRENT, OUTPUT POWER,
GATE CURRENT AND EFFICIENCY vs.
INPUT POWER

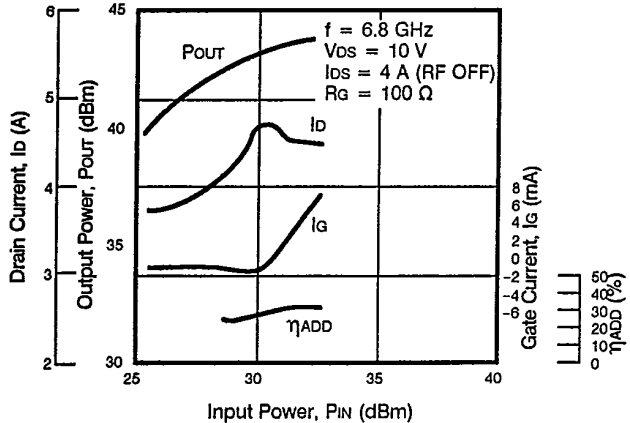

NEZ7784-15B
DRAIN CURRENT, OUTPUT POWER,
AND EFFICIENCY vs. INPUT POWER

