

Thyristor/Diode and Thyristor/Thyristor, 200A (New INT-A-PAK Power Modules)

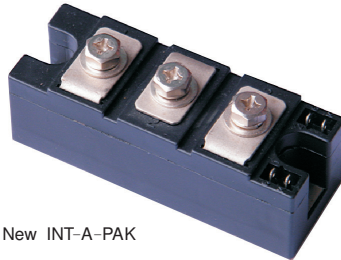

New INT-A-PAK

FEATURES

- High voltage
- Electrically isolated by DBC ceramic (Al_2O_3)
- 3500 V_{RMS} isolating voltage
- Industrial standard package
- High surge capability
- Glass passivated chips
- Modules uses high voltage power thyristor/diodes in two basic configurations
- Simple mounting
- UL approved file E320098
- Compliant to RoHS
- Designed and qualified for multiple level

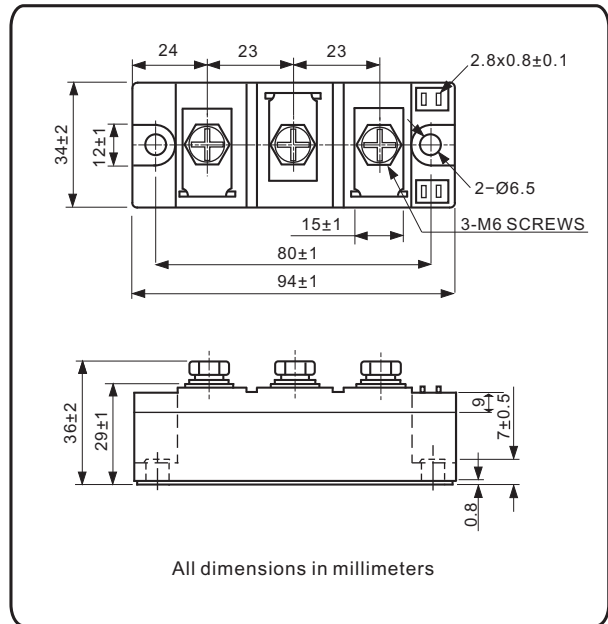

APPLICATIONS

- DC motor control and drives
- Battery charges
- Welders
- Power converters
- Lighting control
- Heat and temperature control

NKT

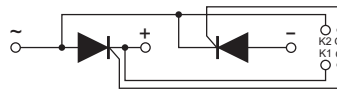
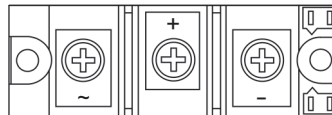

NKH

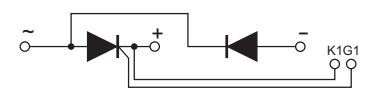
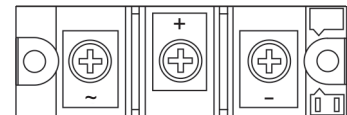

PRODUCT SUMMARY

$I_{T(AV)}$	200 A
-------------	-------

MAJOR RATINGS AND CHARACTERISTICS

SYMBOL	CHARACTERISTICS	VALUES	UNITS
$I_{T(AV)}$	85 C	200	A
$I_{T(RMS)}$	85 C	314	A
I_{TSM}	50 Hz	7200	
	60 Hz	7560	
I^2t	50 Hz	259	kA^2s
	60 Hz	236	
$I^2\sqrt{t}$		2592	$kA^2\sqrt{s}$
V_{DRM} / V_{RRM}	Range	400 to 1600	V
T_J	Range	-40 to 125	C

ELECTRICAL SPECIFICATIONS

VOLTAGE RATINGS				
TYPE NUMBER	VOLTAGE CODE	V_{RRM}/V_{DRM} , MAXIMUM REPETITIVE PEAK REVERSE VOLTAGE V	V_{RSM}/V_{DSM} , MAXIMUM NON-REPETITIVE PEAK REVERSE VOLTAGE V	I_{RRM}/I_{DRM} AT 125 °C mA
NKT200 NKH200	04	400	500	30
	08	800	900	
	12	1200	1300	
	14	1400	1500	
	16	1600	1700	

FORWARD CONDUCTION								
PARAMETER	SYMBOL	TEST CONDITIONS		VALUES	UNITS			
Maximum average on-state current at case temperature	$I_{T(AV)}$	180 conduction, half sine wave ,50Hz		200	A			
				85	°C			
Maximum RMS on-state current	$I_{T(RMS)}$	180 conduction, half sine wave ,50Hz , $T_C = 85^\circ\text{C}$		314				
Maximum peak, one-cycle, on-state non-repetitive surge current	I_{TSM}	t = 10 ms	No voltage reappplied	Sine half wave, initial $T_J = T_J$ maximum	7200	A		
		t = 8.3 ms			7560			
Maximum I^2t for fusing	I^2t	t = 10 ms			100% V_{RRM} reappplied		259	kA ² s
		t = 8.3 ms					236	
		t = 10 ms	181					
		t = 8.3 ms	165					
Maximum $I^2\sqrt{t}$ for fusing	$I^2\sqrt{t}$	t = 0.1 ms to 10 ms, no voltage reappplied		2592	kA ² \sqrt{s}			
Maximum on-state voltage drop	V_{TM}	$I_{TM} = 480\text{A}$, $T_J = 25^\circ\text{C}$, 180 conduction		1.7	V			
Maximum forward voltage drop	V_{FM}	$I_{FM} = 480\text{A}$, $T_J = 25^\circ\text{C}$, 180 conduction		1.4				
Maximum holding current	I_H	Anode supply = 12 V initial $I_T = 30\text{A}$, $T_J = 25^\circ\text{C}$		40~150	mA			
Maximum latching current	I_L	Anode supply = 12 V resistive load = 1 Ω Gate pulse: 10 V, 100 μs , $T_J = 25^\circ\text{C}$		400				

BLOCKING					
PARAMETER	SYMBOL	TEST CONDITIONS		VALUES	UNITS
Maximum peak reverse and off-state leakage current	I_{RRM} , I_{DRM}	$T_J = 125^\circ\text{C}$		30	mA
RMS isolation Voltage	V_{ISO}	50 Hz, circuit to base, all terminals shorted		2500 (1min) 3500 (1s)	V
Critical rate of rise of off-state voltage	dV/dt	$T_J = T_J$ maximum, exponential to 67 % rated V_{DRM}		500	V/ μs

TRIGGERING					
PARAMETER	SYMBOL	TEST CONDITIONS		VALUES	UNITS
Maximum peak gate power	P_{GM}	$t_p \leq 5 \text{ ms}$, $T_J = T_J \text{ maximum}$		10	W
Maximum average gate power	$P_{G(AV)}$	$f = 50 \text{ Hz}$, $T_J = T_J \text{ maximum}$		3	
Maximum peak gate current	I_{GM}	$t_p \leq 5 \text{ ms}$, $T_J = T_J \text{ maximum}$		3	A
Maximum peak negative gate voltage	$-V_{GT}$			10	V
Maximum required DC gate voltage to trigger	V_{GT}	$T_J = 25 \text{ }^\circ\text{C}$	Anode supply = 12 V, resistive load; $R_a = 1 \Omega$	0.7~1.8	
Maximum required DC gate current to trigger	I_{GT}			30~150	
Maximum gate voltage that will not trigger	V_{GD}	$T_J = T_J \text{ maximum}$, 66.7% V_{DRM} applied		0.25	V
Maximum gate current that will not trigger	I_{GD}			10	mA
Maximum rate of rise of turned-on current	di/dt	$T_J = 25^\circ\text{C}$, $I_{GM} = 1.5\text{A}$, $t_r \leq 0.5 \mu\text{s}$		150	A/ μs

THERMAL AND MECHANICAL SPECIFICATIONS					
PARAMETER	SYMBOL	TEST CONDITIONS		VALUES	UNITS
Maximum junction operating temperature range	T_J			- 40 to 125	C
Maximum storage temperature range	T_{Stg}			- 40 to 150	
Maximum thermal resistance, junction to case per junction	R_{thJC}	DC operation		0.14	C/W
Maximum thermal resistance, case to heatsink per module	R_{thCS}	Mounting surface, smooth, flat and greased		0.025	
Mounting torque 10 % IAP to heatsink, M6 busbar to IAP, M6		A mounting compound is recommended and the torque should be rechecked after a period of 3 hours to allow for the spread of the compound. Lubricated threads.		4 to 6	N.m
Approximate weight				220	g
				7.05	oz.
Case style				New INT-A-PAK	

ORDERING INFORMATION TABLE

Device code	NKT	200	/	16	A
	①	②	③	④	
1	- Module type: NKT for (Thyristor + Thyristor) module NKH for (Thyristor + Diode) module				
2	- Current rating: $I_{T(AV)}$				
3	- Voltage code x 100 = V_{RRM}				
4	- Assembly type, "A" for soldering type				

Nell High Power Products

Fig.1 On-state current vs. voltage characteristic

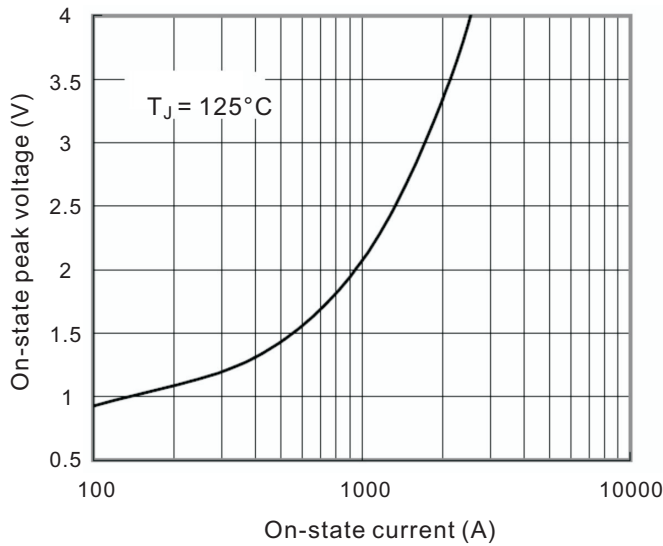

Fig.2 Transient thermal impedance(junction-case)

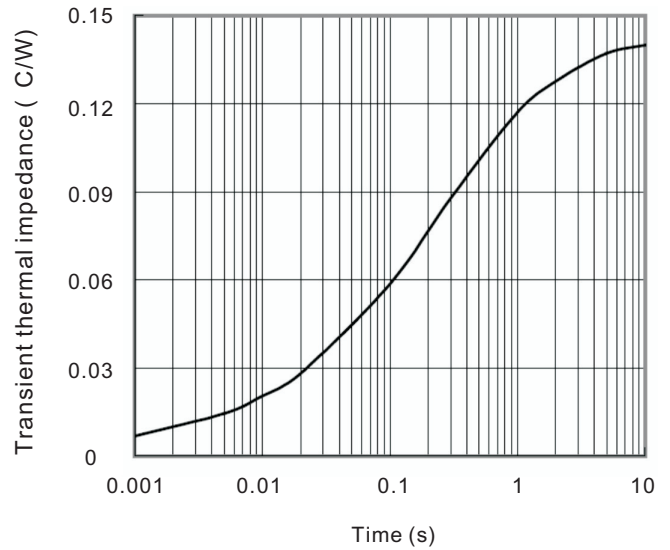

Fig.3 Power consumption vs. average current

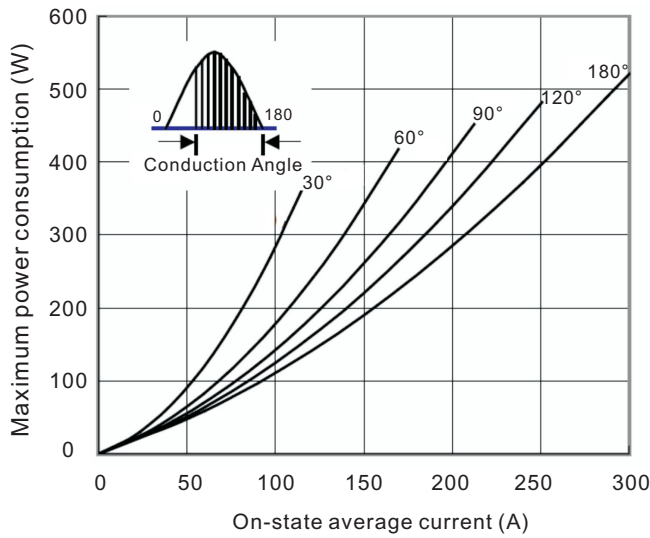

Fig.4 Case temperature vs. on-state average current

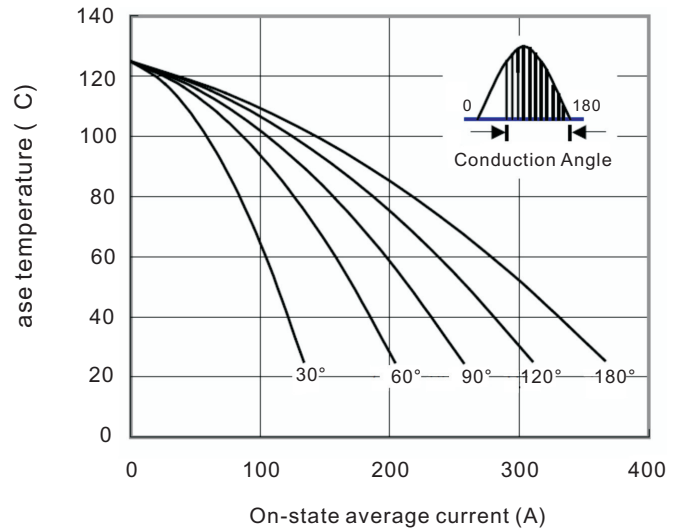

Fig.5 On-state surge current vs cycles

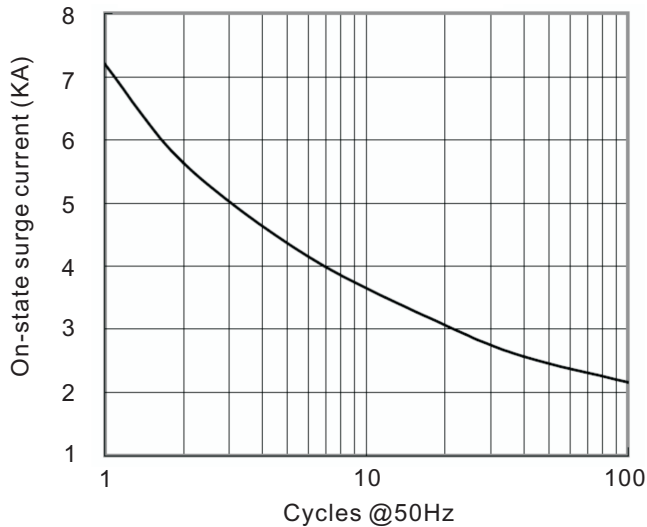

Fig.6 I²t characteristics

