

**Features**

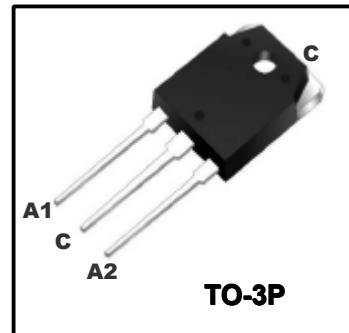
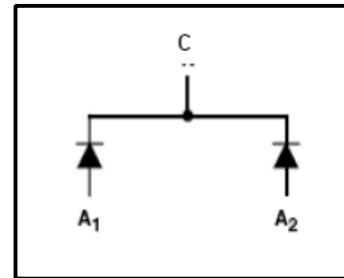
- Ultrafast recovery time
- Low forward voltage drop
- Low leakage current
- High reliability by planer design
- Maximum Junction Temperature Range(175°C)

**General Description**

Winsemi's WSAD92-02 is the state of the art Ultra fast recovery rectifiers specifically designed with optimized performance of forward voltage drop and ultra fast recovery time . The planar structure and the platinum doped life time, control guarantee the best overall performance, ruggedness and reliability characteristics.

**Applications**

- Switching Power Supplies
- Uninterruptable Power Supplies
- Power Switching Circuits
- General Purpose



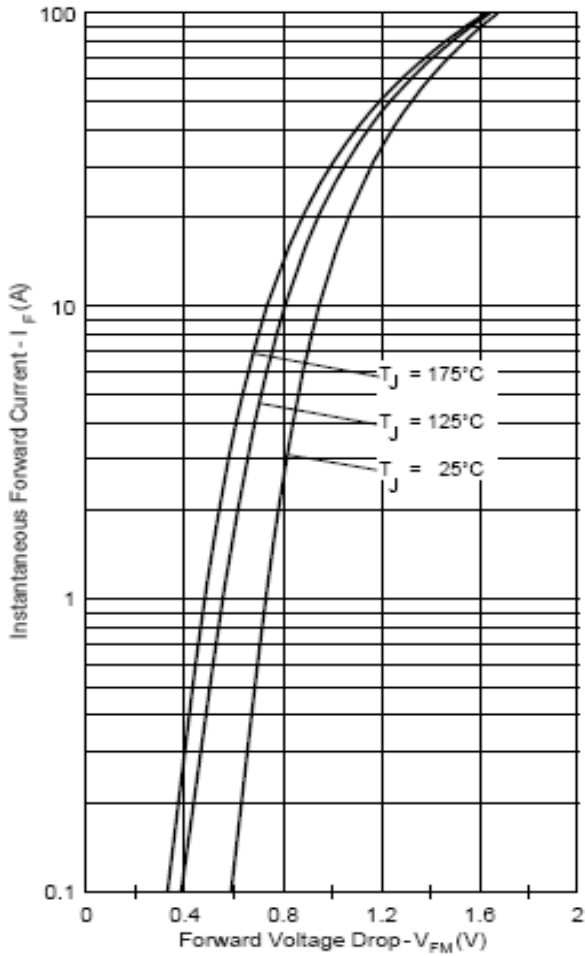
**Absolute Maximum Ratings**

Symbol	Parameter	Value	Units
$V_{RRM}$	Peak Repetitive Reverse Voltage	200	V
$I_{F(AV)}$	Average Out Current Square wave, duty=1/2, Tc=115°C	20	A
$I_{FSM}$	Repetitive Peak Surge Current	100	A
$T_{STG}, T_J$	Operating Junction Temperature & Storage Temperature	-55~175	°C

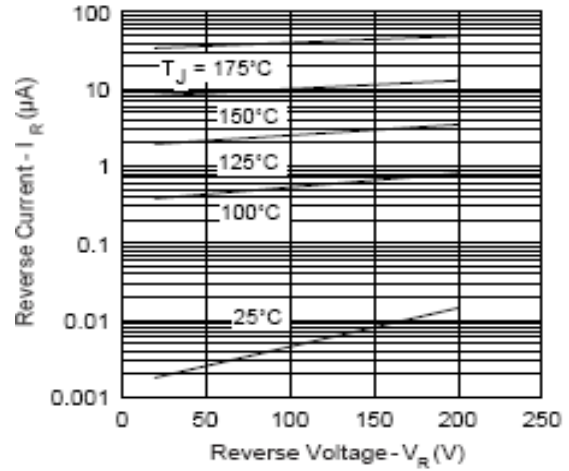
**Electrical Characteristics** (T<sub>c</sub>=25°C unless otherwise noted)

Symbol	Parameter	Test Conditions	Value			Units
			Min	Typ	Max	
$V_F$	Forward Voltage Drop	$I_F=20A$	-	-	1.15	V
		$I_F=10A, T_c=125°C$	-	-	0.8	V
$I_{RRM}$	Reverse Current	$V_R=200V$	-	5	15	μA
		$V_R=200V, T_c=150°C$	-	-	4	mA
$t_{rr}$	Reverse Recovery Time	$I_F=20A, dI_F/dt=100A/μs$	-	-	30	ns
$R_{th(J-C)}$	Thermal Resistance		-	-	1.5	°C/W

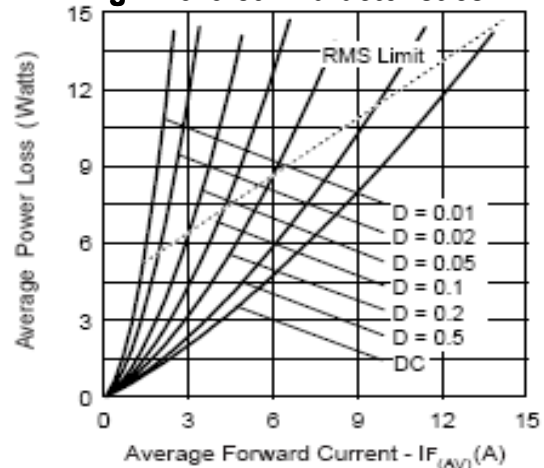
**Typical Performance Curves**



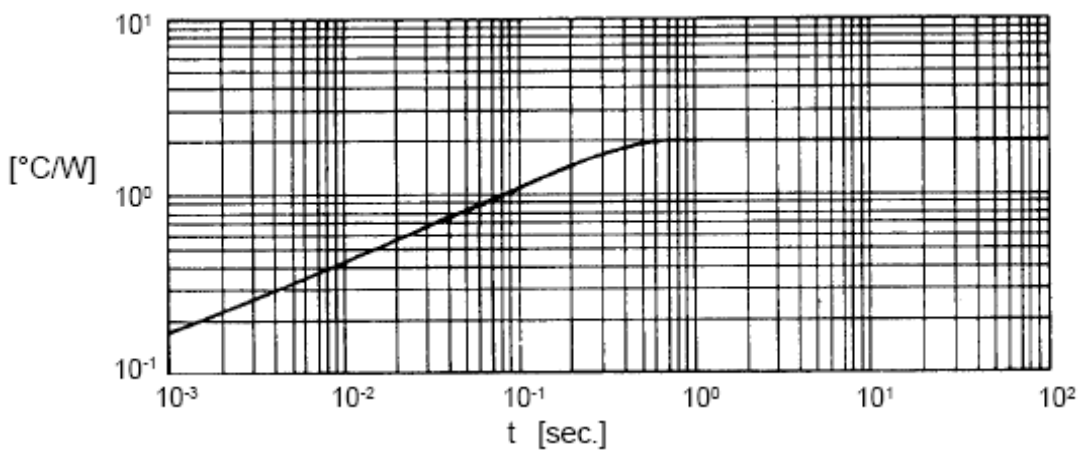
**Fig.1 Forward Characteristics**



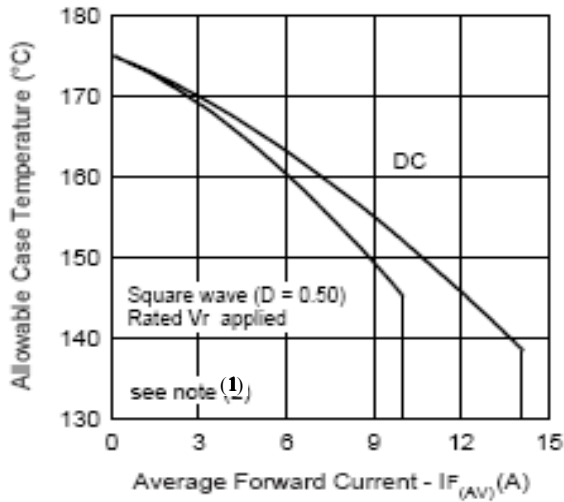
**Fig.2 Reverse Characteristics**



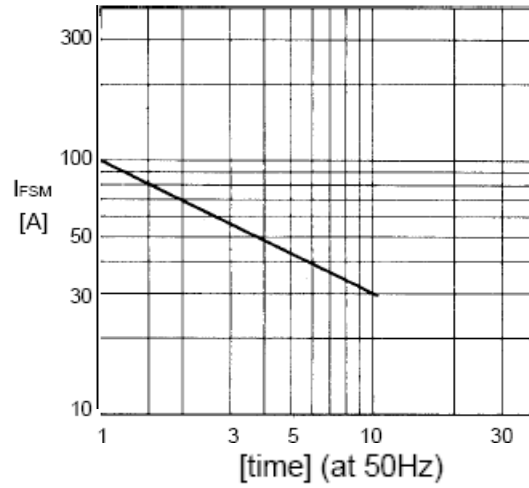
**Fig.3 Forward Power Dissipation**



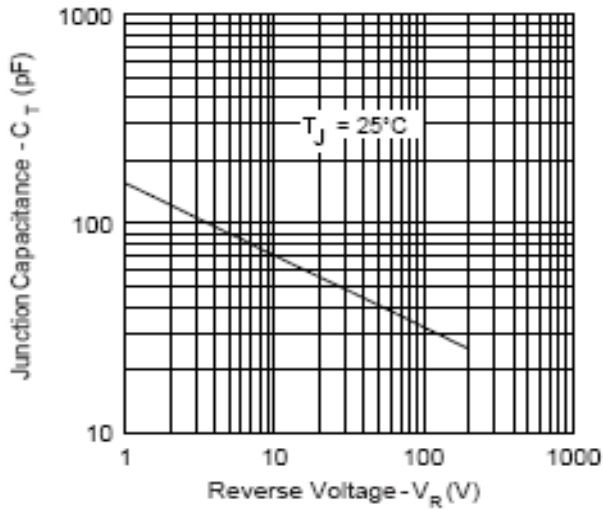
**Fig.4 Transient Thermal Impedance**



**Fig.5 Case Temperature vs Out Current**

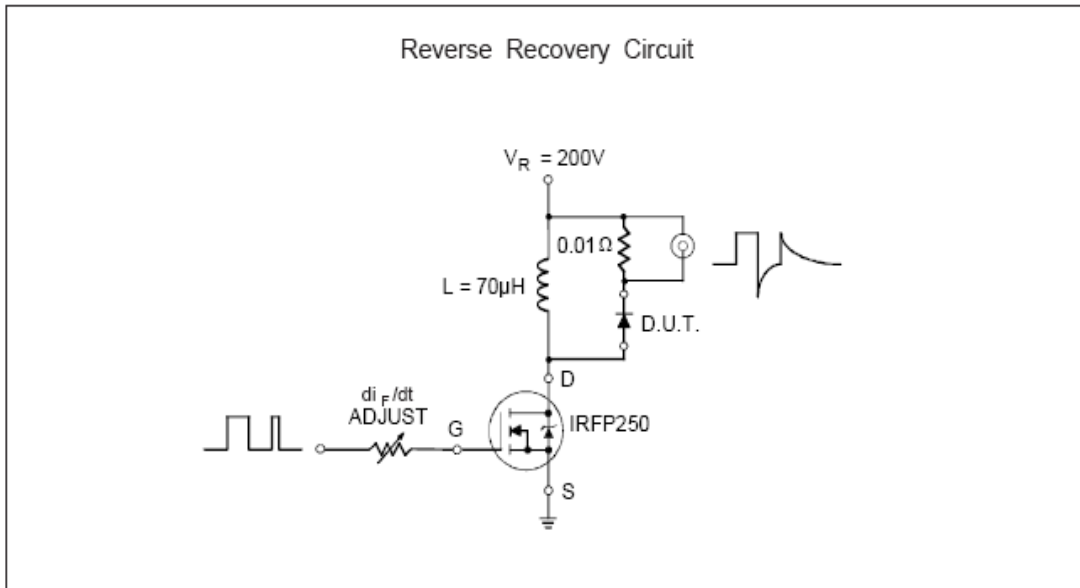


**Fig.6 Surge Capability**

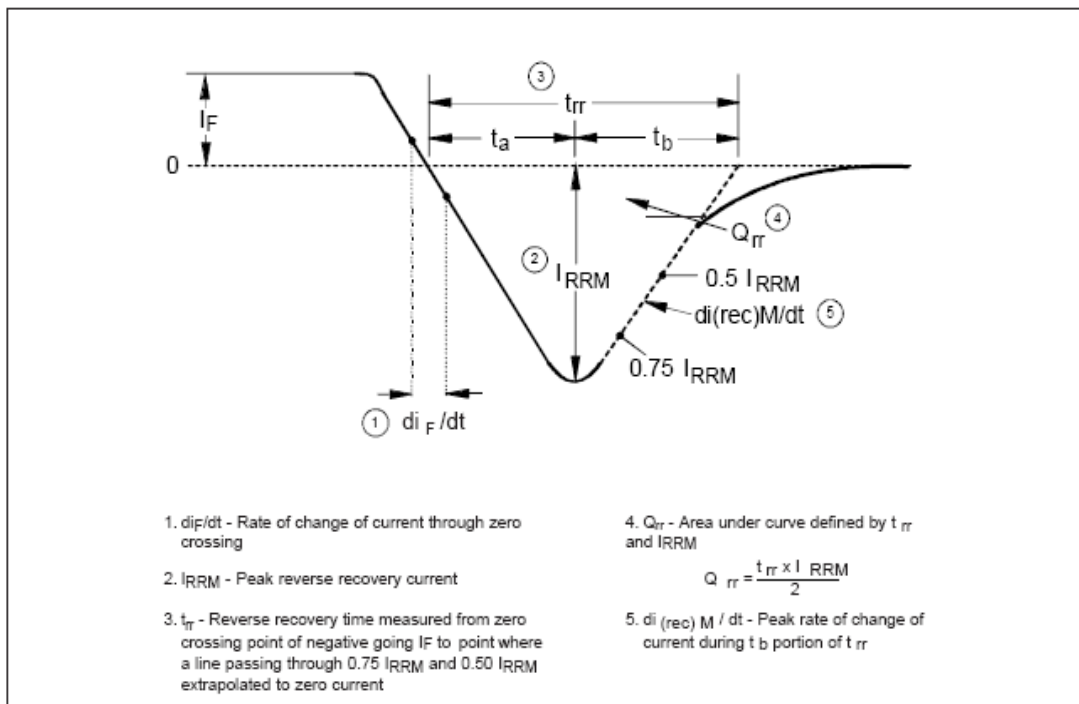


**Fig.7 Junction Capacitance Characteristics**

(1) Formula used:  $T_C = T_J - (Pd + Pd_{REV}) \times R_{thJC}$   
 $Pd = \text{Forward Power Loss} = I_{F(AV)} \times V_{FM} @ (I_{F(AV)} / D)$  (see Fig.3)  
 $Pd_{REV} = \text{Inverse Power Loss} = V_{R1} \times I_R (1 - D); I_R @ V_{R1} = \text{rated } V_R$



**Fig.8 Reverse Recovery Parameter Test Circuit**



**Fig.9 Reverse Recovery Waveform and Definitions**

**TO-3P Package Dimension**

