

请务必在使用敝公司产品之前阅读。

注意

■ 本产品目录中所记载的内容为2018年10月之内容。因改良等原因,可能会不经预告而变更记载内容,所以请务必在使用前先确认最新的产品信息。未按照本产品目录中所记载的内容或交货规格说明书使用敝公司产品的,即便其致使使用设备发生损害、瑕疵等时,敝公司也不承担任何责任,敬请悉知。

■ 就规格相关的详细内容,敝公司备有交货规格说明书,详情请向敝公司咨询。

■ 使用敝公司产品时,请务必事先安装到设备之后,在实际使用的环境下进行评估和确认。

■ 本产品目录中所记载的产品可使用于一般电子设备 [音像设备、办公自动化设备、家电产品、办公设备、信息/通讯设备 (手机、电脑等)] 以及医疗设备 (国际 (IMDRF) 第一类, 第二类)。因此,若考虑将本产品目录中所记载的产品使用于可能会直接危及生命或身体的设备 [运输用设备 (汽车驱动控制设备、火车控制设备、船舶控制设备等)、交通信号设备、防灾设备、医疗设备 (国际 (IMDRF) 第三类)、高公共性信息通信设备 (电话交换机以及电话、无线、广播电视等基站)] 等时,请务必事先向敝公司咨询。

另外,请勿将敝公司产品使用于对安全性和可靠性要求较高的设备 (航天设备、航空设备*、医疗设备 (国际 (IMDRF) 第四类)、原子能控制设备、海底设备、军事设备等)。

※ 注释: 仅限于对航空设备的安全运行不产生直接干扰的设备 [机内娱乐设备、机内照明设备、电动座椅、餐饮设备等], 在满足敝公司另行指定的相关条件时, 亦可将敝公司产品用于以上用途。在贵公司考虑将敝公司的产品用于以上用途时, 请务必事先向敝公司咨询相关的信息。

且即便属于一般电子设备, 使用于对安全性和可靠性要求较高的设备、电路上时, 敝公司建议进行充分的安全评估, 并根据需要, 在设计时追加保护电路等。

未经敝公司的事先书面同意, 把本产品目录中所记载的产品使用于前述需要向敝公司咨询的设备或敝公司禁止使用的设备, 从而给客户或第三方造成损害的, 敝公司不承担任何责任, 敬请悉知。

■ 本产品目录中所记载的信息是用于说明相关产品的典型操作以及相关应用。此类信息的使用不代表对于敝公司以及第三方的知识产权以及其他权利的使用许可或是不侵权保证。

■ 敝公司产品的保证范围仅限于交付的敝公司产品单品, 就敝公司产品的故障或瑕疵所诱发的损害, 敝公司不承担任何责任, 敬请悉知。但是, 以书面形式另行签署了交易基本合同书, 品质保证协定书等时, 敝公司将根据该合同等的条件提供保证。

■ 本产品目录中所记载的内容适用于从敝公司营业所、销售子公司、销售代理店 (即“正规销售渠道”) 购买的敝公司产品, 并不适用于从上述以外的渠道购买的敝公司产品, 敬请悉知。

出口相关注意事项

本产品目录中所记载的部分产品在出口时须事先确认《外汇和对外贸易法》以及美国出口管理的相关法规, 并办理相关手续。如有不明之处, 请向敝公司咨询。

金属绕线型片状功率电感器 (MCOIL™ ME 系列)



回流焊

■ 型号标示法

※使用温度范围: -40~+125℃ (包含产品本身发热)

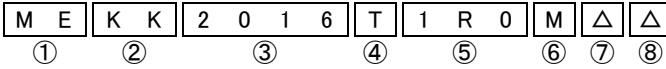

△ = 空格

① 类型

代码	类型
ME	金属绕线型片状功率电感器

② 尺寸 (T)

代码	尺寸 (T) [mm]
KK	1.0

③ 尺寸 (L×W)

代码	尺寸 (L×W) [mm]
2016	2.0 × 1.6
2520	2.5 × 2.0

④ 包装

代码	包装
T	卷盘带装

⑤ 标称电感值

代码 (例)	标称电感值 [μH]
R47	0.47
1R0	1.0
4R7	4.7

※R=小数点

⑥ 电感量公差

代码	电感量公差
M	±20%

⑦ 个别规格

代码	个别规格
△	标准品

⑧ 本公司管理记号

■ 标准外型尺寸 / 标准数量

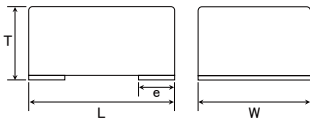

推荐焊盘图案

实装上的注意

- 请确认实装状态后使用。
- 本产品焊法限定为回流焊法。

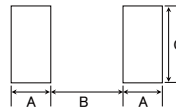

Type	A	B	C
2016	0.7	0.8	1.8
2520	0.9	1.0	2.2

单位: mm

Type	L	W	T	e	标准数量 [pcs] 卷盘带装
MEKK2016	2.0±0.2 (0.079±0.008)	1.6±0.2 (0.063±0.008)	1.0 max (0.039 max)	0.5±0.3 (0.020±0.012)	3000
MEKK2520	2.5±0.2 (0.098±0.008)	2.0±0.2 (0.079±0.008)	1.0 max (0.039 max)	0.65±0.3 (0.026±0.012)	3000

单位: mm (inch)

■ 型号一览

● MEKK2016 型

【厚度:1.0mm max.】

型号	EHS	标称电感值 [μH]	电感量公差	自共振频率 [MHz] (min.)	直流电阻 [Ω] (max.)	额定电流 ※) [mA] (max.)		测试频率 [MHz]
						直流重叠允许电流 Idc1	温度上升允许电流 Idc2	
MEKK2016TR47M	RoHS	0.47	±20%	-	0.030	4,500	4,300	1
MEKK2016TR68M	RoHS	0.68	±20%	-	0.052	3,800	3,300	1
MEKK2016T1R0M	RoHS	1.0	±20%	-	0.060	3,600	3,100	1
MEKK2016T2R2M	RoHS	2.2	±20%	-	0.150	2,400	1,900	1

● MEKK2520 型

【厚度:1.0mm max.】

型号	EHS	标称电感值 [μH]	电感量公差	自共振频率 [MHz] (min.)	直流电阻 [Ω] (max.)	额定电流 ※) [mA] (max.)		测试频率 [MHz]
						直流重叠允许电流 Idc1	温度上升允许电流 Idc2	
MEKK2520TR33M	RoHS	0.33	±20%	-	0.022	6,400	5,100	1
MEKK2520TR47M	RoHS	0.47	±20%	-	0.025	5,900	4,800	1
MEKK2520T1R0M	RoHS	1.0	±20%	-	0.053	4,300	3,300	1
MEKK2520T1R5M	RoHS	1.5	±20%	-	0.069	3,200	2,800	1
MEKK2520T2R2M	RoHS	2.2	±20%	-	0.097	3,100	2,400	1
MEKK2520T4R7M	RoHS	4.7	±20%	-	0.240	1,600	1,500	1

※) 直流重叠允许电流 (Idc1) 为直流重叠带来的电感值下降, 范围在30%以内的直流电感值 (at 20℃)

※) 温度上升允许电流 (Idc2) 为温度上升到40℃时的直流电感值 (at 20℃)

※) 最大额定电流值为能够满足直流重叠允许电流和温度上升允许电流的直流电流值

※) Idc2 测试基板规格

材料: FR4
基板尺寸: 100×50×1.6t mm
焊盘尺寸: 45×45 mm (双面基板)
焊盘厚度: 70 μm

▶ 由于篇幅有限, 本产品目录中只记载了有代表性的产品规格, 若考虑使用弊公司产品时, 请确认交货规格说明书中的详细规格。另外, 有关各产品的详细信息(特性图、可靠性信息、使用时的注意事项等), 请参阅弊网站 (<http://www.ty-top.com/>)。

金属绕线型片状功率电感器 (MCOIL™ ME-H 系列)



回流焊

■ 型号标示法

※使用温度范围: -40~+125°C (包含产品本身发热)

M	E	K	K	2	0	1	6	H	1	R	0	M	△	△
①	②	③	④	⑤	⑥	⑦	⑧							

△ = 空格

① 类型

代码	类型
ME	金属绕线型片状功率电感器

② 尺寸 (T)

代码	尺寸 (T) [mm]
KK	1.0

③ 尺寸 (L×W)

代码	尺寸 (L×W) [mm]
2012	2.0×1.2
2016	2.0×1.6

④ 包装

代码	包装
H	编带 (高特性规格)

⑤ 标称电感值

代码 (例)	标称电感值 [μH]
R47	0.47
1R0	1.0
2R2	2.2

※R=小数点

⑥ 电感量公差

代码	电感量公差
M	±20%

⑦ 个别规格

代码	个别规格
△	标准品

⑧ 本公司管理记号

■ 标准外型尺寸 / 标准数量

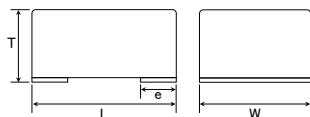

推荐焊盘图案
实装上的注意
· 请确认实装状态后使用。
· 本产品焊法限定为回流焊法。

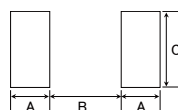

Type	A	B	C
2012	0.7	0.8	1.4
2016	0.7	0.8	1.8

单位: mm

Type	L	W	T	e	标准数量 [pcs] 卷盘带装
MEKK2012H	2.0±0.2 (0.079±0.008)	1.2±0.2 (0.047±0.008)	1.0 max (0.039 max)	0.5±0.3 (0.020±0.012)	3000
MEKK2016H	2.0±0.2 (0.079±0.008)	1.6±0.2 (0.063±0.008)	1.0 max (0.039 max)	0.5±0.3 (0.020±0.012)	3000

单位: mm (inch)

■ 型号一览

● MEKK2012H 型 【厚度:1.0mm max.】

型号	EHS	标称电感值 [μH]	电感量公差	自共振频率 [MHz] (min.)	直流电阻 [Ω] (max.)	额定电流 ※) [mA] (max.)		测试频率 [MHz]
						直流重叠允许电流 Idc1	温度上升允许电流 Idc2	
MEKK2012HR47M	RoHS	0.47	±20%	-	0.030	4,500	4,200	1

● MEKK2016H 型 【厚度:1.0mm max.】

型号	EHS	标称电感值 [μH]	电感量公差	自共振频率 [MHz] (min.)	直流电阻 [Ω] (max.)	额定电流 ※) [mA] (max.)		测试频率 [MHz]
						直流重叠允许电流 Idc1	温度上升允许电流 Idc2	
MEKK2016HR47M	RoHS	0.47	±20%	-	0.026	5,300	4,700	1
MEKK2016HR1R0M	RoHS	1.0	±20%	-	0.048	4,000	3,500	1
MEKK2016HR2R2M	RoHS	2.2	±20%	-	0.100	2,300	2,300	1

※) 直流重叠允许电流 (Idc1) 为直流重叠带来的电感值下降, 范围在30%以内的直流电感值 (at 20°C)

※) 温度上升允许电流 (Idc2) 为温度上升到40°C时的直流电感值 (at 20°C)

※) 最大额定电流值为能够满足直流重叠允许电流和温度上升允许电流的直流电流值

※) Idc2 测试基板规格

材料: FR4
基板尺寸: 100×50×1.6t mm
焊盘尺寸: 45×45 mm (双面基板)
焊盘厚度: 70 μm

▶ 由于篇幅有限, 本产品目录中只记载了有代表性的产品规格, 若考虑使用弊公司产品时, 请确认交货规格说明书中的详细规格。另外, 有关各产品的详细信息(特性图、可靠性信息、使用时的注意事项等), 请参阅弊司网站(<http://www.ty-top.com/>)。

METAL WIRE-WOUND CHIP POWER INDUCTORS (MCOIL™ ME SERIES/MCOIL™ ME-H SERIES)

PACKAGING

① Minimum Quantity

Type	Standard Quantity [pcs]
	Tape & Reel
MEKK2012	3000
MEKK2016	3000
MEKK2520	3000

② Tape Material

● Embossed Tape

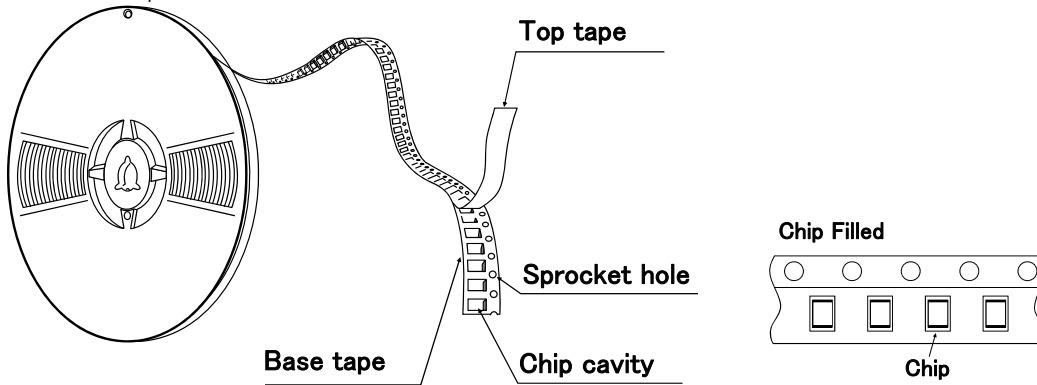

③ Taping dimensions

● Embossed tape 8mm wide (0.315 inches wide)

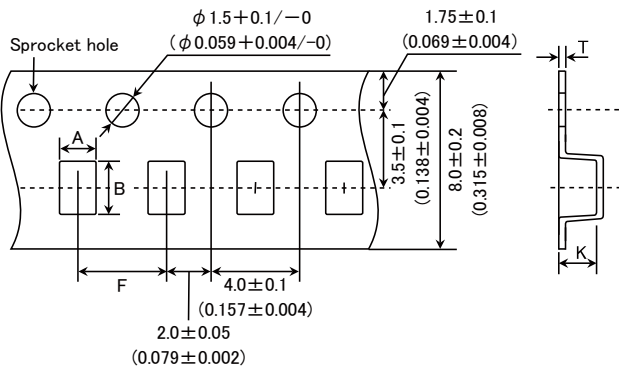

Type	Chip cavity		Insertion pitch	Tape thickness	
	A	B	F	T	K
MEKK2012	1.45 ± 0.1 (0.057 ± 0.004)	2.25 ± 0.1 (0.089 ± 0.004)	4.0 ± 0.1 (0.157 ± 0.004)	0.25 ± 0.05 (0.009 ± 0.002)	1.1 ± 0.1 (0.043 ± 0.004)
MEKK2016	1.9 ± 0.1 (0.075 ± 0.004)	2.45 ± 0.1 (0.097 ± 0.004)	4.0 ± 0.1 (0.157 ± 0.004)	0.25 ± 0.05 (0.009 ± 0.002)	1.2 ± 0.1 (0.047 ± 0.004)
MEKK2520	2.4 ± 0.1 (0.094 ± 0.004)	2.9 ± 0.1 (0.114 ± 0.004)	4.0 ± 0.1 (0.157 ± 0.004)	0.25 ± 0.05 (0.009 ± 0.002)	1.1 ± 0.1 (0.043 ± 0.004)

Unit: mm (inch)

④ Leader and Blank portion

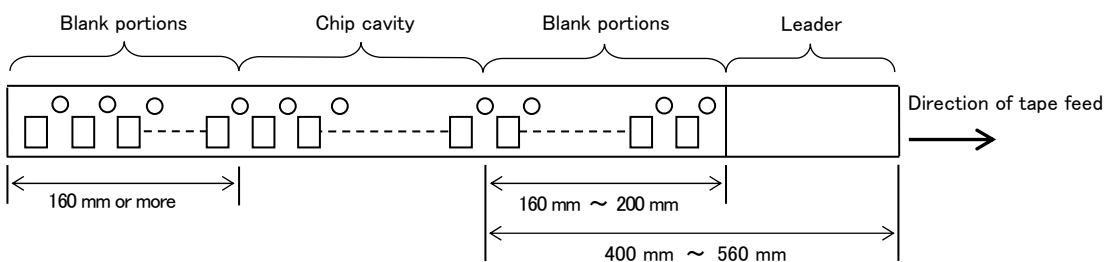

▶ This catalog contains the typical specification only due to the limitation of space. When you consider the purchase of our products, please check our specification. For details of each product (characteristics graph, reliability information, precautions for use, and so on), see our Web site (<http://www.ty-top.com/>).

⑤ Reel size



Type	Reel size (Reference values)		
	ϕD	ϕd	W
MEKK2012	180+0/-3 (7.087+0/-0.118)	60+1/-0 (2.36+0.039/0)	10.0±1.5 (0.394±0.059)
MEKK2016			
MEKK2520			

Unit : mm (inch)

⑥ Top Tape Strength

The top tape requires a peel-off force of 0.1 to 1.0N in the direction of the arrow as illustrated below.

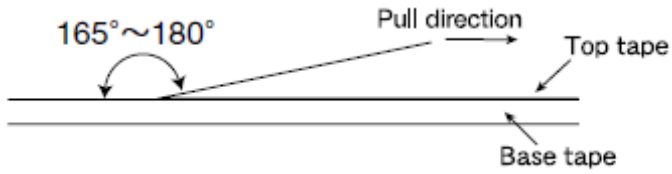

METAL WIRE-WOUND CHIP POWER INDUCTORS (MCOIL™ ME SERIES/MCOIL™ ME-H SERIES)

RELIABILITY DATA

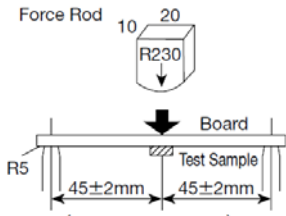
1. Operating Temperature Range		
Specified Value	ME series	-40 ~ +125°C
	ME-H series	
Test Methods and Remarks	Including self-generated heat	
2. Storage Temperature Range		
Specified Value	ME series	-40 ~ +85°C
	ME-H series	
Test Methods and Remarks	0 to 40°C for the product with taping.	
3. Rated current		
Specified Value	ME series	Within the specified tolerance
	ME-H series	
4. Inductance		
Specified Value	ME series	Within the specified tolerance
	ME-H series	
Test Methods and Remarks	Measuring equipment : LCR Meter (HP 4294A or equivalent) Measuring frequency : 1MHz, 0.5V	
5. DC Resistance		
Specified Value	ME series	Within the specified tolerance
	ME-H series	
Test Methods and Remarks	Measuring equipment : DC ohmmeter (HIOKI 3227 or equivalent)	
6. Self resonance frequency		
Specified Value	ME series	-
	ME-H series	
7. Temperature characteristic		
Specified Value	ME series	Inductance change : Within $\pm 15\%$
	ME-H series	
Test Methods and Remarks	Measurement of inductance shall be taken at temperature range within -40°C ~ +125°C. With reference to inductance value at +20°C., change rate shall be calculated.	
8. Resistance to flexure of substrate		
Specified Value	ME series	No damage
	ME-H series	
Test Methods and Remarks	<p>The test samples shall be soldered to the test board by the reflow. As illustrated below, apply force in the direction of the arrow indicating until deflection of the test board reaches to 2 mm.</p> <p>Test board size : 100 × 40 × 1.0 mm Test board material : Glass epoxy-resin Solder cream thickness : 0.12 mm</p> 	

▶ This catalog contains the typical specification only due to the limitation of space. When you consider the purchase of our products, please check our specification.
 For details of each product (characteristics graph, reliability information, precautions for use, and so on), see our Web site (<http://www.ty-top.com/>).

9. Insulation resistance : between wires		
Specified Value	ME series	—
	ME-H series	

10. Insulation resistance : between wire and over-coating		
Specified Value	ME series	DC25V 100k Ωmin
	ME-H series	

11. Withstanding voltage : between wire and over-coating		
Specified Value	ME series	—
	ME-H series	

12. Adhesion of terminal electrode		
Specified Value	ME series	No abnormality.
	ME-H series	
Test Methods and Remarks	The test samples shall be soldered to the test board by the reflow. Applied force : 10N to X and Y directions. Duration : 5s. Solder cream thickness : 0.12mm.	

13. Resistance to vibration															
Specified Value	ME series	Inductance change : Within ±10% No significant abnormality in appearance.													
	ME-H series														
Test Methods and Remarks	The test samples shall be soldered to the test board by the reflow. Then it shall be submitted to below test conditions.														
	<table border="1"> <tr> <td>Frequency Range</td> <td colspan="2">10~55Hz</td> </tr> <tr> <td>Total Amplitude</td> <td colspan="2">1.5mm (May not exceed acceleration 196m/s²)</td> </tr> <tr> <td>Sweeping Method</td> <td colspan="2">10Hz to 55Hz to 10Hz for 1min.</td> </tr> <tr> <td rowspan="3">Time</td> <td>X</td> <td rowspan="3">For 2 hours on ach X, Y, and Z axis.</td> </tr> <tr> <td>Y</td> </tr> <tr> <td>Z</td> </tr> </table>		Frequency Range	10~55Hz		Total Amplitude	1.5mm (May not exceed acceleration 196m/s ²)		Sweeping Method	10Hz to 55Hz to 10Hz for 1min.		Time	X	For 2 hours on ach X, Y, and Z axis.	Y
Frequency Range	10~55Hz														
Total Amplitude	1.5mm (May not exceed acceleration 196m/s ²)														
Sweeping Method	10Hz to 55Hz to 10Hz for 1min.														
Time	X	For 2 hours on ach X, Y, and Z axis.													
	Y														
	Z														
Recovery : At least 2hrs of recovery under the standard condition after the test, followed by the measurement within 48hrs.															

14. Solderability					
Specified Value	ME series	At least 90% of surface of terminal electrode is covered by new solder.			
	ME-H series				
Test Methods and Remarks	The test samples shall be dipped in flux, and then immersed in molten solder as shown in below table. Flux : Methanol solution containing rosin 25%.				
	<table border="1"> <tr> <td>Solder Temperature</td> <td>245±5°C</td> </tr> <tr> <td>Time</td> <td>5±0.5 sec.</td> </tr> </table>		Solder Temperature	245±5°C	Time
Solder Temperature	245±5°C				
Time	5±0.5 sec.				
※Immersion depth : All sides of mounting terminal shall be immersed.					

15. Resistance to soldering heat		
Specified Value	ME series	Inductance change : Within ±10% No significant abnormality in appearance.
	ME-H series	
Test Methods and Remarks	The test sample shall be exposed to reflow oven at 230°C for 40 seconds, with peak temperature at 260+0/−5°C for 5 seconds, 2 times.	
	Test board material : Glass epoxy-resin Test board thickness : 1.0mm Recovery : At least 2hrs of recovery under the standard condition after the test, followed by the measurement within 48hrs.	

▶ This catalog contains the typical specification only due to the limitation of space. When you consider the purchase of our products, please check our specification.
 For details of each product (characteristics graph, reliability information, precautions for use, and so on), see our Web site (<http://www.ty-top.com/>).

16. Thermal shock			
Specified Value	ME series	Inductance change : Within $\pm 10\%$ No significant abnormality in appearance.	
	ME-H series		
Test Methods and Remarks	The test samples shall be soldered to the test board by the reflow. The test samples shall be placed at specified temperature for specified time by step 1 to step 4 as shown in below table in sequence. The temperature cycle shall be repeated 100 cycles.		
	Conditions of 1 cycle		
	Step	Temperature ($^{\circ}\text{C}$)	Duration (min)
	1	-40 ± 3	30 ± 3
	2	Room temperature	Within 3
	3	$+85 \pm 2$	30 ± 3
4	Room temperature	Within 3	
Recovery : At least 2hrs of recovery under the standard condition after the test, followed by the measurement within 48hrs.			

17. Damp heat		
Specified Value	ME series	Inductance change : Within $\pm 10\%$ No significant abnormality in appearance.
	ME-H series	
Test Methods and Remarks	The test samples shall be soldered to the test board by the reflow.	
	The test samples shall be placed in thermostatic oven set at specified temperature and humidity as shown in below table.	
	Temperature	$60 \pm 2^{\circ}\text{C}$
	Humidity	$90 \sim 95\% \text{RH}$
	Time	$500 + 24 / - 0$ hour
Recovery : At least 2hrs of recovery under the standard condition after the test, followed by the measurement within 48hrs.		

18. Loading under damp heat		
Specified Value	ME series	Inductance change : Within $\pm 10\%$ No significant abnormality in appearance.
	ME-H series	
Test Methods and Remarks	The test samples shall be soldered to the test board by the reflow.	
	The test samples shall be placed in thermostatic oven set at specified temperature and humidity and applied the rated current continuously as shown in below table.	
	Temperature	$60 \pm 2^{\circ}\text{C}$
	Humidity	$90 \sim 95\% \text{RH}$
	Applied current	Rated current
	Time	$500 + 24 / - 0$ hour
Recovery : At least 2hrs of recovery under the standard condition after the test, followed by the measurement within 48hrs.		

19. Low temperature life test		
Specified Value	ME series	Inductance change : Within $\pm 10\%$ No significant abnormality in appearance.
	ME-H series	
Test Methods and Remarks	The test samples shall be soldered to the test board by the reflow. After that, the test samples shall be placed at test conditions as shown in below table.	
	Temperature	$-40 \pm 2^{\circ}\text{C}$
	Time	$500 + 24 / - 0$ hour
	Recovery : At least 2hrs of recovery under the standard condition after the test, followed by the measurement within 48hrs.	

20. High temperature life test		
Specified Value	ME series	Inductance change : Within $\pm 10\%$ No significant abnormality in appearance.
	ME-H series	
Test Methods and Remarks	The test samples shall be soldered to the test board by the reflow. After that, the test samples shall be placed at test conditions as shown in below table.	
	Temperature	$125 \pm 2^{\circ}\text{C}$
	Time	$500 + 24 / - 0$ hour
	Recovery : At least 2hrs of recovery under the standard condition after the test, followed by the measurement within 48hrs.	

21. Loading at high temperature life test		
Specified Value	ME series	—
	ME-H series	

▶ This catalog contains the typical specification only due to the limitation of space. When you consider the purchase of our products, please check our specification. For details of each product (characteristics graph, reliability information, precautions for use, and so on), see our Web site (<http://www.ty-top.com/>).

22. Standard condition

Specified Value	ME series	Standard test condition : Unless otherwise specified, temperature is $20 \pm 15^{\circ}\text{C}$ and $65 \pm 20\%$ of relative humidity. When there is any question concerning measurement result: In order to provide correlation data, the test shall be condition of $20 \pm 2^{\circ}\text{C}$ of temperature, $65 \pm 5\%$ relative humidity. Inductance is in accordance with our measured value.
	ME-H series	

METAL WIRE-WOUND CHIP POWER INDUCTORS (MCOIL™ ME SERIES/MCOIL™ ME-H SERIES)

PRECAUTIONS

1. Circuit Design

Precautions	<ul style="list-style-type: none"> ◆Operating environment 1. The products described in this specification are intended for use in general electronic equipment,(office supply equipment, telecommunications systems, measuring equipment, and household equipment). They are not intended for use in mission-critical equipment or systems requiring special quality and high reliability (traffic systems, safety equipment, aerospace systems, nuclear control systems and medical equipment including life-support systems,) where product failure might result in loss of life, injury or damage. For such uses, contact TAIYO YUDEN Sales Department in advance.
-------------	---

2. PCB Design

Precautions	<ul style="list-style-type: none"> ◆Land pattern design 1. Please refer to a recommended land pattern.
Technical considerations	<ul style="list-style-type: none"> ◆Land pattern design Surface Mounting ▪ Mounting and soldering conditions should be checked beforehand. ▪ Applicable soldering process to this products is reflow soldering only.

3. Considerations for automatic placement

Precautions	<ul style="list-style-type: none"> ◆Adjustment of mounting machine 1. Excessive impact load should not be imposed on the products when mounting onto the PC boards. 2. Mounting and soldering conditions should be checked beforehand.
Technical considerations	<ul style="list-style-type: none"> ◆Adjustment of mounting machine 1. When installing products, care should be taken not to apply distortion stress as it may deform the products.

4. Soldering

Precautions	<ul style="list-style-type: none"> ◆Reflow soldering 1. Please contact any of our offices for a reflow soldering, and refer to the recommended condition specified. 2. The product shall be used reflow soldering only. 3. Please do not add any stress to a product until it returns in normal temperature after reflow soldering. ◆Lead free soldering 1. When using products with lead free soldering, we request to use them after confirming adhesion, temperature of resistance to soldering heat, soldering etc sufficiently.
Technical considerations	<ul style="list-style-type: none"> ◆Reflow soldering 1. If products are used beyond the range of the recommended conditions, heat stresses may deform the products, and consequently degrade the reliability of the products. <p>Recommended reflow condition (Pb free solder)</p>

5. Cleaning

Precautions	<ul style="list-style-type: none"> ◆Cleaning conditions 1. Washing by supersonic waves shall be avoided.
Technical considerations	<ul style="list-style-type: none"> ◆Cleaning conditions 1. If washed by supersonic waves, the products might be broken.

▶ This catalog contains the typical specification only due to the limitation of space. When you consider the purchase of our products, please check our specification. For details of each product (characteristics graph, reliability information, precautions for use, and so on), see our Web site (<http://www.ty-top.com/>).

6. Handling	
Precautions	<ul style="list-style-type: none"> ◆ Handling <ol style="list-style-type: none"> 1. Keep the product away from all magnets and magnetic objects. ◆ Breakaway PC boards (splitting along perforations) <ol style="list-style-type: none"> 1. When splitting the PC board after mounting product, care should be taken not to give any stresses of deflection or twisting to the board. 2. Board separation should not be done manually, but by using the appropriate devices. ◆ Mechanical considerations <ol style="list-style-type: none"> 1. Please do not give the product any excessive mechanical shocks. 2. Please do not add any shock and power to a product in transportation. ◆ Pick-up pressure <ol style="list-style-type: none"> 1. Please do not push to add any pressure to a winding part. Please do not give any shock and push into a ferrite core exposure part. ◆ Packing <ol style="list-style-type: none"> 1. Please avoid accumulation of a packing box as much as possible.
Technical considerations	<ul style="list-style-type: none"> ◆ Handling <ol style="list-style-type: none"> 1. There is a case that a characteristic varies with magnetic influence. ◆ Breakaway PC boards (splitting along perforations) <ol style="list-style-type: none"> 1. The position of the product on PCBs shall be carefully considered to minimize the stress caused from splitting of the PCBs. ◆ Mechanical considerations <ol style="list-style-type: none"> 1. There is a case to be damaged by a mechanical shock. 2. There is a case to be broken by the handling in transportation. ◆ Pick-up pressure <ol style="list-style-type: none"> 1. Damage and a characteristic can vary with an excessive shock or stress. ◆ Packing <ol style="list-style-type: none"> 1. If packing boxes are accumulated, that could cause a deformation on packing tapes or a damage on the products.
7. Storage conditions	
Precautions	<ul style="list-style-type: none"> ◆ Storage <ol style="list-style-type: none"> 1. To maintain the solderability of terminal electrodes and to keep the packing material in good condition, temperature and humidity in the storage area should be controlled. <ul style="list-style-type: none"> ▪ Recommended conditions <ul style="list-style-type: none"> Ambient temperature : 0~40°C Humidity : Below 70% RH ▪ The ambient temperature must be kept below 30°C. Even under ideal storage conditions, solderability of products electrodes may decrease as time passes. <ul style="list-style-type: none"> For this reason, product should be used within 6 months from the time of delivery. In case of storage over 6 months, solderability shall be checked before actual usage.
Technical considerations	<ul style="list-style-type: none"> ◆ Storage <ol style="list-style-type: none"> 1. Under a high temperature and humidity environment, problems such as reduced solderability caused by oxidation of terminal electrodes and deterioration of taping/packaging materials may take place.

金属多层片状功率电感器 (MCOIL™ MC 系列)

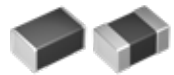

回流焊

■ 型号标示法

※使用温度范围: -40~+125°C (包含产品本身发热)

M	C	K	K	2	0	1	2	T	1	R	0	M	△	△
①	②	③	④	⑤	⑥	⑦	⑧							

△=空格

①类型

代码	类型
MC	金属多层片状功率电感器

②产品厚度 (T)

代码	产品厚度 (T) [mm]
EE	0.55 max
FK	0.60 max
FE	0.65 max
HK	0.80 max
KK	1.0 max

③尺寸 (L×W)

代码	外型 (inch)	尺寸 (L×W) [mm]
1005	1005(0402)	1.0×0.5
1608	1608(0603)	1.6×0.8
2012	2012(0805)	2.0×1.25

④包装

代码	包装
T	卷盘带装

⑤标称电感值

代码 (例)	标称电感值 [μH]
R24	0.24
R47	0.47
1R0	1.0

※R=小数点

⑥电感量公差

代码	电感量公差
M	±20%

⑦本公司管理记号 1

代码	本公司管理记号 1
△	标准品
G	电极5面品
H	标准品 (内部代码)

⑧本公司管理记号 2

代码	本公司管理记号 2
△	无表示
N	有极性表示

■ 标准外型尺寸 / 标准数量

标准品

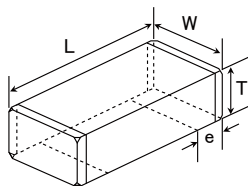

极性表示产品

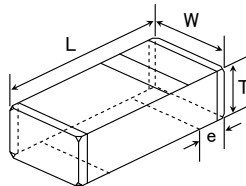

电极5面品

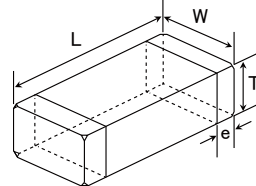

型号	L	W	T	e	标准数量 [pcs]	
					纸带	压纹带
MCEE1005 (0402)	1.0±0.2 (0.039±0.008)	0.5±0.2 (0.020±0.008)	0.55 max (0.022 max)	0.25±0.15 (0.010±0.006)	10000	
MCFK1608 (0603)	1.6±0.2 (0.063±0.008)	0.8±0.2 (0.031±0.008)	0.60 max (0.024 max)	0.3±0.2 (0.012±0.008)	4000	—
MCFE1608 (0603)	1.6±0.2 (0.063±0.008)	0.8±0.2 (0.031±0.008)	0.65 max (0.026 max)	0.3±0.2 (0.012±0.008)	4000	—
MCKK1608 (0603)	1.6±0.2 (0.063±0.008)	0.8±0.2 (0.031±0.008)	1.0 max (0.039 max)	0.3±0.2 (0.012±0.008)	—	3000
MCHK2012 (0805)	2.0±0.2 (0.079±0.008)	1.25±0.2 (0.049±0.008)	0.80 max (0.031 max)	0.5±0.3 (0.02±0.012)	4000	—
MCKK2012 (0805)	2.0±0.2 (0.079±0.008)	1.25±0.2 (0.049±0.008)	1.0 max (0.039 max)	0.5±0.3 (0.02±0.012)	—	3000

单位: mm (inch)

▶ 由于篇幅有限, 本产品目录中只记载了有代表性的产品规格, 若考虑使用弊公司产品时, 请确认交货规格说明书中的详细规格。另外, 有关各产品的详细信息(特性图、可靠性信息、使用时的注意事项等), 请参阅弊司网站(<http://www.ty-top.com/>)。

●MC1005

型号	EHS	标称电感值 [μH]	电感量公差	直流电阻 [mΩ]		额定电流 (Idc1) [A] (max.)	额定电流 (Idc2) [A] (max.)	测试频率 [MHz]	厚度 [mm] (max.)
				(max.)	(typ.)				
MCEE1005TR10MHN	RoHS	0.10	±20%	50	41	2.00	2.00	1	0.55
MCEE1005TR22MHN	RoHS	0.22	±20%	80	65	1.60	1.60	1	0.55
MCEE1005TR47MHN	RoHS	0.47	±20%	140	114	1.20	1.20	1	0.55
MCEE1005TR10MHN	RoHS	1.0	±20%	300	244	1.00	0.80	1	0.55

●MC1608

型号	EHS	标称电感值 [μH]	电感量公差	直流电阻 [mΩ]		额定电流 (Idc1) [A] (max.)	额定电流 (Idc2) [A] (max.)	测试频率 [MHz]	厚度 [mm] (max.)
				(max.)	(typ.)				
MCFK1608TR24M	RoHS	0.24	±20%	50	40	2.30	2.10	1	0.60
MCFK1608TR47M	RoHS	0.47	±20%	85	69	1.90	1.60	1	0.60
MCFK1608TR10M	RoHS	1.0	±20%	224	182	1.50	0.90	1	0.60
MCFE1608TR24MG	RoHS	0.24	±20%	100	75	2.60	1.50	1	0.65
MCFE1608TR47MG	RoHS	0.47	±20%	150	114	2.00	1.20	1	0.65
MCFE1608TR10MG	RoHS	1.0	±20%	340	270	1.40	0.80	1	0.65
MCKK1608TR24M N	RoHS	0.24	±20%	38	35	2.80	2.60	1	1.00
MCKK1608TR47M N	RoHS	0.47	±20%	55	44	2.40	2.00	1	1.00
MCKK1608TR10M N	RoHS	1.0	±20%	123	100	2.00	1.30	1	1.00

●MC2012

型号	EHS	标称电感值 [μH]	电感量公差	直流电阻 [mΩ]		额定电流 (Idc1) [A] (max.)	额定电流 (Idc2) [A] (max.)	测试频率 [MHz]	厚度 [mm] (max.)
				(max.)	(typ.)				
MCHK2012TR24M	RoHS	0.24	±20%	24	19	4.32	3.60	1	0.80
MCHK2012TR47M	RoHS	0.47	±20%	36	30	3.21	3.15	1	0.80
MCHK2012TR10M	RoHS	1.0	±20%	111	90	2.26	1.47	1	0.80
MCKK2012TR24M	RoHS	0.24	±20%	25	20	6.20	4.00	1	1.00
MCKK2012TR47M	RoHS	0.47	±20%	39	32	4.50	3.10	1	1.00
MCKK2012TR10M	RoHS	1.0	±20%	90	73	3.60	2.10	1	1.00

※) 直流重叠允许电流 (Idc1) 为直流重叠带来的电感值下降, 范围在30%以内的直流电感值 (at 20°C)

※) 额定电流(Idc2): 直流电流负载时, 由自发热引起的温度上升达40°C以下的电流值 (20°C)

Multilayer chip inductors

Multilayer chip inductors for high frequency, Multilayer chip bead inductors

Multilayer common mode choke coils (MC series F type)

Metal Multilayer Chip Power Inductors (MCOIL™ MC series)

PACKAGING

① Minimum Quantity

● Tape & Reel Packaging

Type	Thickness mm (inch)	Standard Quantity [pcs]	
		Paper Tape	Embossed Tape
CK1608(0603)	0.8 (0.031)	4000	—
CK2125(0805)	0.85(0.033)	4000	—
	1.25(0.049)	—	2000
CKS2125(0805)	0.85(0.033)	4000	—
	1.25(0.049)	—	2000
CKP1608(0603)	0.8 (0.031)	4000	—
CKP2012(0805)	0.9 (0.035)	—	3000
CKP2016(0806)	0.9 (0.035)	—	3000
CKP2520(1008)	0.7 (0.028)	—	3000
	0.9 (0.035)	—	3000
	1.1 (0.043)	—	2000
LK1005(0402)	0.5 (0.020)	10000	—
LK1608(0603)	0.8 (0.031)	4000	—
LK2125(0805)	0.85(0.033)	4000	—
	1.25(0.049)	—	2000
HK0603(0201)	0.3 (0.012)	15000	—
HK1005(0402)	0.5 (0.020)	10000	—
HK1608(0603)	0.8 (0.031)	4000	—
HK2125(0805)	0.85(0.033)	—	4000
	1.0 (0.039)	—	3000
HKQ0603W(0201)	0.3 (0.012)	15000	—
HKQ0603S(0201)	0.3 (0.012)	15000	—
HKQ0603U(0201)	0.3 (0.012)	15000	—
AQ105(0402)	0.5 (0.020)	10000	—
BK0603(0201)	0.3 (0.012)	15000	—
BK1005(0402)	0.5 (0.020)	10000	—
BKH0603(0201)	0.3 (0.012)	15000	—
BKH1005(0402)	0.5 (0.020)	10000	—
BK1608(0603)	0.8 (0.031)	4000	—
BK2125(0805)	0.85(0.033)	4000	—
	1.25(0.049)	—	2000
BK2010(0804)	0.45(0.018)	4000	—
BK3216(1206)	0.8 (0.031)	—	4000
BKP0603(0201)	0.3 (0.012)	15000	—
BKP1005(0402)	0.5 (0.020)	10000	—
BKP1608(0603)	0.8 (0.031)	4000	—
BKP2125(0805)	0.85(0.033)	4000	—
MCF0605(0202)	0.3 (0.012)	15000	—
MCF0806(0302)	0.4 (0.016)	—	10000
MCF1210(0504)	0.55(0.022)	—	5000
MCF2010(0804)	0.45(0.018)	—	4000
MCEE1005(0402)	0.55(0.022)	10000	—
MCFK1608(0603)	0.6 (0.024)	4000	—
MCFE1608(0603)	0.65(0.026)	4000	—
MCKK1608(0603)	1.0 (0.039)	—	3000
MCHK2012(0806)	0.8 (0.031)	4000	—
MCKK2012(0805)	1.0 (0.039)	—	3000

▶ This catalog contains the typical specification only due to the limitation of space. When you consider the purchase of our products, please check our specification. For details of each product (characteristics graph, reliability information, precautions for use, and so on), see our Web site (<http://www.ty-top.com/>).

② Taping material

● Card board carrier tape

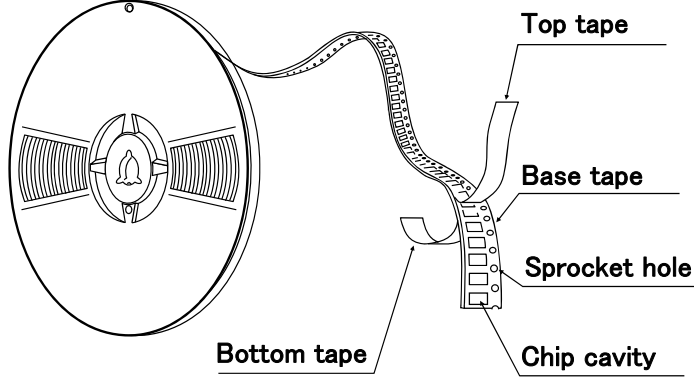

CK	1608
CKP	1608
CK	2125
CKS	2125
LK	1005
LK	1608
LK	2125
HK	0603
HK	1005
HK	1608
HKQ	0603
AQ	105

BK	0603
BK	1005
BK	1608
BK	2125
BK	2010
BKP	0603
BKP	1005
BKP	1608
BKP	2125
BKH	0603
BKH	1005
MCF	0605
MC	1005
MC	1608
MC	2012

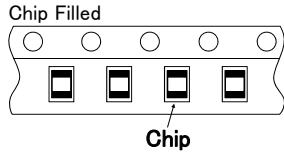

● Embossed Tape

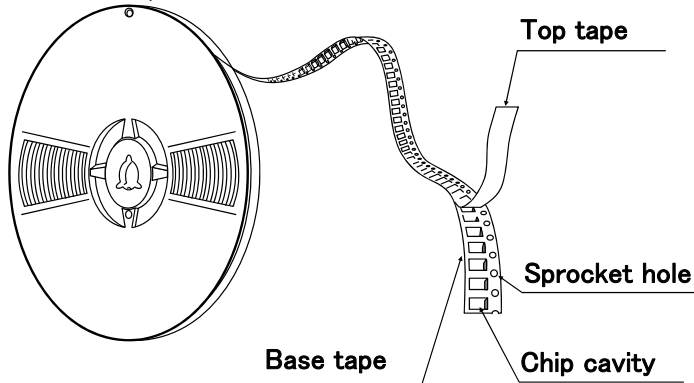

CK	2125
CKS	2125
CKP	2012
CKP	2016
CKP	2520
LK	2125
HK	2125

BK	2125
BK	3216
MCF	0806
MCF	1210
MCF	2010
MC	1608
MC	2012

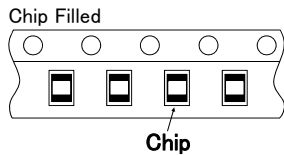

③ Taping Dimensions

● Paper tape (8mm wide)

Unit: mm (inch)

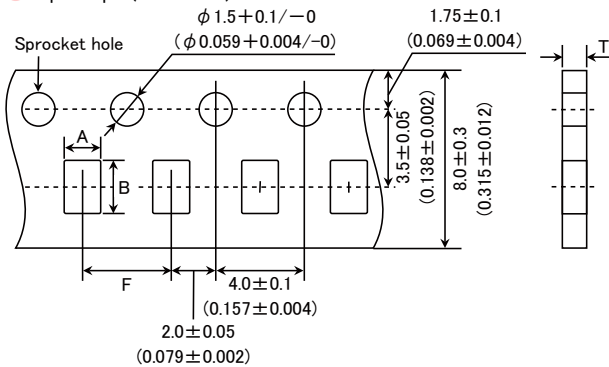

▶ This catalog contains the typical specification only due to the limitation of space. When you consider the purchase of our products, please check our specification. For details of each product (characteristics graph, reliability information, precautions for use, and so on), see our Web site (<http://www.ty-top.com/>).

Type	Thickness mm (inch)	Chip cavity		Insertion Pitch	Tape Thickness
		A	B	F	T
CK1608(0603)	0.8 (0.031)	1.0±0.2 (0.039±0.008)	1.8±0.2 (0.071±0.008)	4.0±0.1 (0.157±0.004)	1.1max (0.043max)
CK2125(0805)	0.85(0.033)	1.5±0.2 (0.059±0.008)	2.3±0.2 (0.091±0.008)	4.0±0.1 (0.157±0.004)	1.1max (0.043max)
CKS2125(0805)	0.85(0.033)	1.5±0.2 (0.059±0.008)	2.3±0.2 (0.091±0.008)	4.0±0.1 (0.157±0.004)	1.1max (0.043max)
CKP1608(0603)	0.8 (0.031)	1.0±0.2 (0.039±0.008)	1.8±0.2 (0.071±0.008)	4.0±0.1 (0.157±0.004)	1.1max (0.043max)
LK1005(0402)	0.5 (0.020)	0.65±0.1 (0.026±0.004)	1.15±0.1 (0.045±0.004)	2.0±0.05 (0.079±0.002)	0.8max (0.031max)
LK1608(0603)	0.8 (0.031)	1.0±0.2 (0.039±0.008)	1.8±0.2 (0.071±0.008)	4.0±0.1 (0.157±0.004)	1.1max (0.043max)
LK2125(0805)	0.85(0.033)	1.5±0.2 (0.059±0.008)	2.3±0.2 (0.091±0.008)	4.0±0.1 (0.157±0.004)	1.1max (0.043max)
HK0603(0201)	0.3 (0.012)	0.40±0.06 (0.016±0.002)	0.70±0.06 (0.028±0.002)	2.0±0.05 (0.079±0.002)	0.45max (0.018max)
HK1005(0402)	0.5 (0.020)	0.65±0.1 (0.026±0.004)	1.15±0.1 (0.045±0.004)	2.0±0.05 (0.079±0.002)	0.8max (0.031max)
HK1608(0603)	0.8 (0.031)	1.0±0.2 (0.039±0.008)	1.8±0.2 (0.071±0.008)	4.0±0.1 (0.157±0.004)	1.1max (0.043max)
HKQ0603W(0201)	0.3 (0.012)	0.40±0.06 (0.016±0.002)	0.70±0.06 (0.028±0.002)	2.0±0.05 (0.079±0.002)	0.45max (0.018max)
HKQ0603S(0201)	0.3 (0.012)	0.40±0.06 (0.016±0.002)	0.70±0.06 (0.028±0.002)	2.0±0.05 (0.079±0.002)	0.45max (0.018max)
HKQ0603U(0201)	0.3 (0.012)	0.40±0.06 (0.016±0.002)	0.70±0.06 (0.028±0.002)	2.0±0.05 (0.079±0.002)	0.45max (0.018max)
AQ105(0402)	0.5 (0.020)	0.75±0.1 (0.030±0.004)	1.15±0.1 (0.045±0.004)	2.0±0.05 (0.079±0.002)	0.8max (0.031max)
BK0603(0201)	0.3 (0.012)	0.40±0.06 (0.016±0.002)	0.70±0.06 (0.028±0.002)	2.0±0.05 (0.079±0.002)	0.45max (0.018max)
BK1005(0402)	0.5 (0.020)	0.65±0.1 (0.026±0.004)	1.15±0.1 (0.045±0.004)	2.0±0.05 (0.079±0.002)	0.8max (0.031max)
BK1608(0603)	0.8 (0.031)	1.0±0.2 (0.039±0.008)	1.8±0.2 (0.071±0.008)	4.0±0.1 (0.157±0.004)	1.1max (0.043max)
BK2125(0805)	0.85(0.033)	1.5±0.2 (0.059±0.008)	2.3±0.2 (0.091±0.008)	4.0±0.1 (0.157±0.004)	1.1max (0.043max)
BK2010(0804)	0.45(0.018)	1.2±0.1 (0.047±0.004)	2.17±0.1 (0.085±0.004)	4.0±0.1 (0.157±0.004)	0.8max (0.031max)
BKP0603(0201)	0.3 (0.012)	0.40±0.06 (0.016±0.002)	0.70±0.06 (0.028±0.002)	2.0±0.05 (0.079±0.002)	0.45max (0.018max)
BKP1005(0402)	0.5 (0.020)	0.65±0.1 (0.026±0.004)	1.15±0.1 (0.045±0.004)	2.0±0.05 (0.079±0.002)	0.8max (0.031max)
BKP1608(0603)	0.8 (0.031)	1.0±0.2 (0.039±0.008)	1.8±0.2 (0.071±0.008)	4.0±0.1 (0.157±0.004)	1.1max (0.043max)
BKP2125(0805)	0.85(0.033)	1.5±0.2 (0.059±0.008)	2.3±0.2 (0.091±0.008)	4.0±0.1 (0.157±0.004)	1.1max (0.043max)
BKH0603(0201)	0.3 (0.012)	0.40±0.06 (0.016±0.002)	0.70±0.06 (0.028±0.002)	2.0±0.05 (0.079±0.002)	0.45max (0.018max)
BKH1005(0402)	0.5 (0.020)	0.65±0.1 (0.026±0.004)	1.15±0.1 (0.045±0.004)	2.0±0.05 (0.079±0.002)	0.8max (0.031max)
MCF0605(0202)	0.3 (0.012)	0.62±0.03 (0.024±0.001)	0.77±0.03 (0.030±0.001)	2.0±0.05 (0.079±0.002)	0.45max (0.018max)
MCFK1608(0603)	0.6 (0.024)	1.1±0.05 (0.043±0.002)	1.9±0.05 (0.075±0.002)	4.0±0.1 (0.157±0.004)	0.72max (0.028max)
MCEE1005(0402)	0.55(0.021)	0.8±0.05 (0.031±0.002)	1.3±0.05 (0.051±0.002)	2.0±0.05 (0.079±0.002)	0.6max (0.016max)
MCFE1608(0603)	0.65(0.026)	1.1±0.05 (0.043±0.002)	1.9±0.05 (0.075±0.002)	4.0±0.1 (0.157±0.004)	0.9max (0.035max)
MCHK2012(0805)	0.8 (0.031)	1.55±0.2 (0.061±0.008)	2.3±0.2 (0.091±0.008)	4.0±0.1 (0.157±0.004)	0.9max (0.035max)

Unit : mm (inch)

● Embossed Tape (8mm wide)

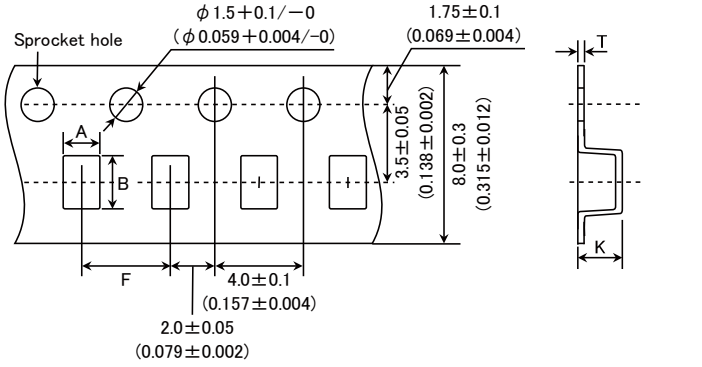

Type	Thickness mm (inch)	Chip cavity		Insertion Pitch	Tape Thickness	
		A	B	F	K	T
CK2125(0805)	1.25 (0.049)	1.5 ± 0.2 (0.059 ± 0.008)	2.3 ± 0.2 (0.091 ± 0.008)	4.0 ± 0.1 (0.157 ± 0.004)	2.0 (0.079)	0.3 (0.012)
CKS2125(0805)	1.25 (0.049)	1.5 ± 0.2 (0.059 ± 0.008)	2.3 ± 0.2 (0.091 ± 0.008)	4.0 ± 0.1 (0.157 ± 0.004)	2.0 (0.079)	0.3 (0.012)
CKP2012(0805)	0.9 (0.035)	1.55 ± 0.2 (0.061 ± 0.008)	2.3 ± 0.2 (0.091 ± 0.008)	4.0 ± 0.1 (0.157 ± 0.004)	1.3 (0.051)	0.3 (0.012)
CKP2016(0806)	0.9 (0.035)	1.8 ± 0.1 (0.071 ± 0.004)	2.2 ± 0.1 (0.087 ± 0.004)	4.0 ± 0.1 (0.157 ± 0.004)	1.3 (0.051)	0.25 (0.01)
CKP2520(1008)	0.7 (0.028)	2.3 ± 0.1 (0.091 ± 0.004)	2.8 ± 0.1 (0.110 ± 0.004)	4.0 ± 0.1 (0.157 ± 0.004)	1.4 (0.055)	0.3 (0.012)
	0.9 (0.035)				1.4 (0.055)	
	1.1 (0.043)				1.7 (0.067)	
	1.1 (0.043)				1.7 (0.067)	
LK2125(0805)	1.25 (0.049)	1.5 ± 0.2 (0.059 ± 0.008)	2.3 ± 0.2 (0.091 ± 0.008)	4.0 ± 0.1 (0.157 ± 0.004)	2.0 (0.079)	0.3 (0.012)
HK2125(0805)	0.85 (0.033)	1.5 ± 0.2 (0.059 ± 0.008)	2.3 ± 0.2 (0.091 ± 0.008)	4.0 ± 0.1 (0.157 ± 0.004)	1.5 (0.059)	0.3 (0.012)
	1.0 (0.039)				2.0 (0.079)	
BK2125(0805)	1.25 (0.049)	1.5 ± 0.2 (0.059 ± 0.008)	2.3 ± 0.2 (0.091 ± 0.008)	4.0 ± 0.1 (0.157 ± 0.004)	2.0 (0.079)	0.3 (0.012)
BK3216(1206)	0.8 (0.031)	1.9 ± 0.1 (0.075 ± 0.004)	3.5 ± 0.1 (0.138 ± 0.004)	4.0 ± 0.1 (0.157 ± 0.004)	1.4 (0.055)	0.3 (0.012)
MCF0806(0302)	0.4 (0.016)	0.75 ± 0.05 (0.030 ± 0.002)	0.95 ± 0.05 (0.037 ± 0.002)	2.0 ± 0.05 (0.079 ± 0.002)	0.55 (0.022)	0.3 (0.012)
MCF1210(0504)	0.55 (0.022)	1.15 ± 0.05 (0.045 ± 0.002)	1.40 ± 0.05 (0.055 ± 0.002)	4.0 ± 0.1 (0.157 ± 0.004)	0.65 (0.026)	0.3 (0.012)
MCF2010(0804)	0.45 (0.018)	1.1 ± 0.1 (0.043 ± 0.004)	2.3 ± 0.1 (0.091 ± 0.004)	4.0 ± 0.1 (0.157 ± 0.004)	0.85 (0.033)	0.3 (0.012)
MCKK1608(0603)	1.0 (0.039)	1.1 ± 0.1 (0.043 ± 0.004)	1.95 ± 0.1 (± 0.004)	4.0 ± 0.1 (0.157 ± 0.004)	1.4 (0.055)	0.25 (0.01)
MCKK2012(0805)	1.0 (0.039)	1.55 ± 0.2 (0.061 ± 0.008)	2.3 ± 0.2 (0.091 ± 0.008)	4.0 ± 0.1 (0.157 ± 0.004)	1.35 (0.053)	0.25 (0.010)

Unit : mm (inch)

④ LEADER AND BLANK PORTION

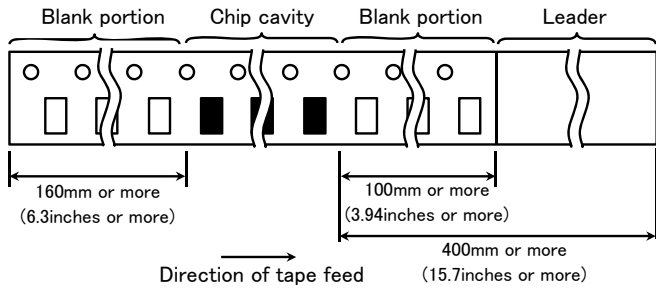

⑤ Reel Size

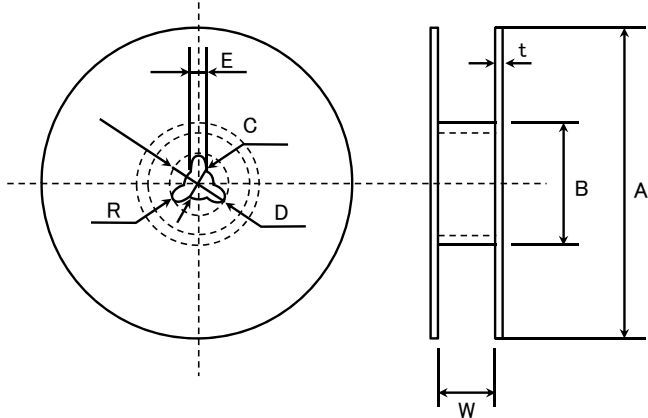

A	B	C	D	E	R
$\phi 178 \pm 2.0$	$\phi 60$ or more	$\phi 13.0 \pm 0.2$	$\phi 21.0 \pm 0.8$	2.0 ± 0.5	1.0

	t	W
4mm width tape	1.5max.	5 ± 1.0
8mm width tape	2.5max.	10 ± 1.5

(Unit : mm)

⑥ Top tape strength

The top tape requires a peel-off force of 0.1~0.7N in the direction of the arrow as illustrated below.

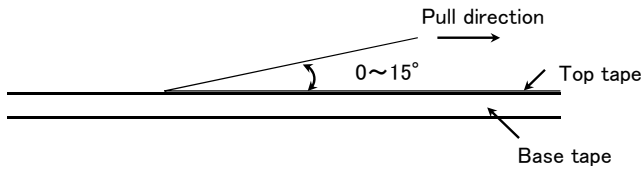

Multilayer chip inductors

Multilayer chip inductors for high frequency, Multilayer chip bead inductors

Multilayer common mode choke coils (MC series F type)

Metal Multilayer Chip Power Inductors (MCOIL™ MC series)

RELIABILITY DATA

1. Operating Temperature Range		
Specified Value	BK series	-55~+125°C
	BKH series	
	BKP series	-55~+85°C
	MCF series	-40~+85°C
	CK series	-40~+85°C
	CKS series	
	CKP series	
	LK series	
	HK0603, HK1005	-55~+125°C
	HK1608, HK2125	-40~+85°C
	HKQ0603	-55~+125°C
	AQ105	
MCOIL™ MC series	-40~+125°C (Including self-generated heat)	

2. Storage Temperature Range		
Specified Value	BK series	-55~+125°C
	BKH series	
	BKP series	-55~+85°C
	MCF series	-40~+85°C
	CK series	-40~+85°C
	CKS series	
	CKP series	
	LK series	
	HK0603, HK1005	-55~+125°C
	HK1608, HK2125	-40~+85°C
	HKQ0603	-55~+125°C
	AQ105	
MCOIL™ MC series	-40~+85°C	

3. Rated Current		
Specified Value	BK series	The temperature of the element is increased within 20°C.
	BKH series	
	BKP series	The temperature of the element is increased within 40°C
	MCF series	Refer to each specification.
	CK series	The temperature of the element is increased within 20°C.
	CKS series	
	CKP series	
	LK series	
	HK0603, HK1005	The decreasing-rate of inductance value is within 5 %
	HK1608, HK2125	
	HKQ0603	
	AQ105	
MCOIL™ MC series	Idc1: The decreasing-rate of inductance value is within 30 % Idc2: The temperature of the element is increased within 40°C	

► This catalog contains the typical specification only due to the limitation of space. When you consider the purchase of our products, please check our specification.
For details of each product (characteristics graph, reliability information, precautions for use, and so on), see our Web site (<http://www.ty-top.com/>).

4. Impedance		
Specified Value	BK series	Refer to each specification.
	BKH series	
	BKP series	
	MCF series	
Test Methods and Remarks	BK0603Series, BKP0603Series, BKH Series	Measuring frequency : 100±1MHz Measuring equipment : 4991A (or its equivalent) Measuring jig : 16193A (or its equivalent)
	BK1005Series, BKP1005Series, BKH1005Series	Measuring frequency : 100±1MHz Measuring equipment : 4291A (or its equivalent) Measuring jig : 16192A (or its equivalent), HW:16193A (or its equivalent)
	BK1608・2125Series, BKP1608・2125Series	Measuring frequency : 100±1MHz Measuring equipment : 4291A (or its equivalent), 4195A (or its equivalent) Measuring jig : 16092A (or its equivalent), HW:16192A (or its equivalent)
	BK2010・3216Series	Measuring frequency : 100±1MHz Measuring equipment : 4291A (or its equivalent), 4195A (or its equivalent) Measuring jig : 16192A (or its equivalent)
	MCF Series	Measuring frequency : 100±1MHz Measuring equipment : 4291A (or its equivalent)

5. Inductance		
Specified Value	CK series	Refer to each specification.
	CKS series	
	CKP series	
	LK series	
	HK0603, HK1005	
	HK1608, HK2125	
	HKQ0603	
	AQ105	
Test Methods and Remarks	MCOIL™ MC series	
	CK, CKS, LK Series	Measuring frequency : Refer to each specification. Measuring equipment /jig : 1608,2125⇒4194A+16085B+16092A (or its equivalent), 4195A+41951+16092A (or its equivalent) 1005⇒4291A+16193A (or its equivalent) Measuring current : 047~4.7 μH ⇒1mArms, 5.6~33 μH ⇒0.1mArms
	CKP, MCOIL™ MC Series	Measuring frequency : 1MHz Measuring equipment : 4285A (or its equivalent)
	HK0603, HK1005, AQ Series	Measuring frequency : 100MHz Measuring equipment /jig : HK0603・AQ105⇒4291A+16197A (or its equivalent) HK1005⇒4291A+16193A (or its equivalent)
	HK1608, HK2125 Series	Measuring frequency : ~100nH⇒100MHz, 120nH⇒50MHz Measuring equipment /jig : 4195A+16092A (or its equivalent)
	HKQ Series	Measuring frequency : HKQ0603S・HKQ0603U⇒500MHz Measuring frequency : HKQ0603W⇒300/500MHz Measuring equipment /jig : E4991A+16197A (or its equivalent)

▶ This catalog contains the typical specification only due to the limitation of space. When you consider the purchase of our products, please check our specification. For details of each product (characteristics graph, reliability information, precautions for use, and so on), see our Web site (<http://www.ty-top.com/>).

6. Q

Specified Value	CK series	—
	CKS series	
	CKP series	
	LK series	
	HK0603, HK1005	
	HK1608, HK2125	
	HKQ0603	
	AQ105	
MCOIL™ MC series	—	
Test Methods and Remarks	LK Series	
	Measuring frequency	: Refer to each specification.
	Measuring equipment /jig	: 1608,2125⇒4194A+16085B+16092A (or its equivalent) 、 4195A+41951+16092A (or its equivalent) 1005⇒4291A+16193A (or its equivalent)
	Measuring current	: 047~4.7 μH ⇒1mArms 、 5.6~33 μH ⇒0.1mArms
	HK0603, HK1005, AQ Series	
	Measuring frequency	: 100MHz
	Measuring equipment /jig	: HK0603・AQ105⇒4291A+16197A (or its equivalent) HK1005⇒4291A+16193A (or its equivalent)
	HK1608, HK2125 Series	
	Measuring frequency	: ~100nH⇒100MHz 、 120nH~⇒50MHz
	Measuring equipment /jig	: 4195A+16092A (or its equivalent)
HKQ Series		
Measuring frequency	: HKQ0603S・HKQ0603U⇒ 500MHz	
Measuring frequency	: HKQ0603W⇒ 300/500MHz	
Measuring equipment /jig	: E4991A+16197A (or its equivalent)	

7. DC Resistance

Specified Value	BK series	Refer to each specification.
	BKH series	
	BKP series	
	MCF series	
	CK series	
	CKS series	
	CKP series	
	LK series	
	HK0603, HK1005	
	HK1608, HK2125	
	HKQ0603	
	AQ105	
MCOIL™ MC series	—	
Test Methods and Remarks	Measuring equipment: VOAC-7412, VOAC-7512, VOAC-7521 (made by Iwasaki Tsushinki), HIOKI3227 (or its equivalent)	

8. Self Resonance Frequency (SRF)

Specified Value	BK series	—
	BKH series	
	BKP series	
	MCF series	
	CK series	
	CKS series	
	CKP series	
	LK series	
	HK0603, HK1005	
	HK1608, HK2125	
	HKQ0603	
	AQ105	
MCOIL™ MC series	—	
Test Methods and Remarks	LK, CK Series :	
	Measuring equipment	: 4195A (or its equivalent)
	Measuring jig	: 41951 + 16092A (or its equivalent)
	HK, HKQ, AQ Series :	
Measuring equipment	: 8719C (or its equivalent) ・8753D (or its equivalent) /HK2125	

▶ This catalog contains the typical specification only due to the limitation of space. When you consider the purchase of our products, please check our specification. For details of each product (characteristics graph, reliability information, precautions for use, and so on), see our Web site (<http://www.ty-top.com/>).

9. Temperature Characteristic		
Specified Value	BK series	—
	BKH series	
	BKP series	
	MCF series	
	CK series	
	CKS series	
	CKP series	
	LK series	
	HK0603, HK1005	
	HK1608, HK2125	
	HKQ0603	
	AQ105	
	MCOIL™ MC series	
	HK0603, HK1005	
HK1608, HK2125		
HKQ0603		
AQ105	Inductance change: Within ±15%	
MCOIL™ MC series		
Test Methods and Remarks	HK, HKQ, AQ Series: Temperature range : -30~+85°C Reference temperature : +20°C MCOIL™ MC series: Temperature range : -40~+85°C Reference temperature : +20°C	

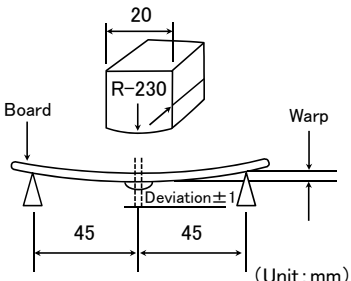
10. Resistance to Flexure of Substrate		
Specified Value	BK series	No mechanical damage.
	BKH series	
	BKP series	
	MCF series	
	CK series	
	CKS series	
	CKP series	
	LK series	
	HK0603, HK1005	
	HK1608, HK2125	
	HKQ0603	
	AQ105	
	MCOIL™ MC series	
	Test Methods and Remarks	
Test Methods and Remarks	 <p>(Unit: mm)</p>	

11. Solderability		
Specified Value	BK series	At least 90% of terminal electrode is covered by new solder.
	BKH series	
	BKP series	
	MCF series	
	CK series	
	CKS series	
	CKP series	
	LK series	
	HK0603, HK1005	
	HK1608, HK2125	
	HKQ0603	
	AQ105	
	MCOIL™ MC series	
	Test Methods and Remarks	

▶ This catalog contains the typical specification only due to the limitation of space. When you consider the purchase of our products, please check our specification. For details of each product (characteristics graph, reliability information, precautions for use, and so on), see our Web site (<http://www.ty-top.com/>).

12. Resistance to Soldering		
Specified Value	BK series	Appearance: No significant abnormality Impedance change: Within $\pm 30\%$
	BKH series	
	BKP series	
	MCF series	Appearance: No significant abnormality Impedance change: Within $\pm 20\%$
	CK series	Appearance: No significant abnormality Inductance change: R10~4R7 \Rightarrow Within $\pm 10\%$, 6R8~100 \Rightarrow Within $\pm 15\%$
	CKS series	Appearance: No significant abnormality Inductance change: Within $\pm 20\%$
	CKP series	Appearance: No significant abnormality Inductance change: Within $\pm 30\%$
	LK series	Appearance: No significant abnormality Inductance change: 1005 \Rightarrow Within $\pm 15\%$ 1608,2125 \Rightarrow 47N~4R7: Within $\pm 10\%$ 5R6~330: Within $\pm 15\%$
	HK0603, HK1005	Appearance: No significant abnormality Inductance change: Within $\pm 5\%$
	HK1608, HK2125	
	HKQ0603	
AQ105		
MCOIL™ MC series	Appearance: No significant abnormality Inductance change: Within $\pm 10\%$	
Test Methods and Remarks	Solder temperature	: $260 \pm 5^\circ\text{C}$
	Duration	: 10 ± 0.5 sec.
	Preheating temperature	: 150 to 180°C
	Preheating time	: 3 min.
	Flux	: Immersion into methanol solution with colophony for 3 to 5 sec.
	Recovery	: 2 to 3 hrs of recovery under the standard condition after the test. (See Note 1)

(Note 1) When there are questions concerning measurement result; measurement shall be made after 48 ± 2 hrs of recovery under the standard condition.

13. Thermal Shock			
Specified Value	BK series	Appearance: No significant abnormality Impedance change: Within $\pm 30\%$	
	BKH series		
	BKP series		
	MCF series	Appearance: No significant abnormality Impedance change: Within $\pm 20\%$	
	CK series	Appearance: No significant abnormality Inductance change: Within $\pm 20\%$	
	CKS series	Appearance: No significant abnormality Inductance change: Within $\pm 20\%$	
	CKP series	Appearance: No significant abnormality Inductance change: Within $\pm 30\%$	
	LK series	Appearance: No significant abnormality Inductance change: Within $\pm 10\%$ Q change: Within $\pm 30\%$	
	HK0603, HK1005	Appearance: No significant abnormality Inductance change: Within $\pm 10\%$ Q change: Within $\pm 20\%$	
	HK1608, HK2125		
	HKQ0603		
AQ105			
MCOIL™ MC series	Appearance: No significant abnormality Inductance change: Within $\pm 10\%$		
Test Methods and Remarks	Conditions for 1 cycle		
	Step	temperature ($^\circ\text{C}$)	time (min.)
	1	Minimum operating temperature $+0/-3$	30 ± 3
	2	Room temperature	2~3
	3	Maximum operating temperature $+3/-0$	30 ± 3
	4	Room temperature	2~3
Number of cycles: 5			
Recovery: 2 to 3 hrs of recovery under the standard condition after the test. (See Note 1)			

(Note 1) When there are questions concerning measurement result; measurement shall be made after 48 ± 2 hrs of recovery under the standard condition.

14. Damp Heat (Steady state)		
Specified Value	BK series	Appearance: No significant abnormality Impedance change: Within $\pm 30\%$
	BKH series	
	BKP series	
	MCF series	Appearance: No significant abnormality Impedance change: Within $\pm 20\%$
	CK series	Appearance: No significant abnormality Inductance change: Within $\pm 20\%$
	CKS series	
	CKP series	Appearance: No significant abnormality Inductance change: Within $\pm 30\%$
	LK series	Appearance: No significant abnormality Inductance change: 1005,1608 \Rightarrow Within $\pm 10\%$ 2125 \Rightarrow Within $\pm 20\%$ Q change: Within $\pm 30\%$
	HK0603, HK1005	Appearance: No significant abnormality Inductance change: Within $\pm 10\%$ Q change: Within $\pm 20\%$
	HK1608, HK2125	
	HKQ0603	
	AQ105	
MCOIL™ MC series	Appearance: No significant abnormality Inductance change: Within $\pm 10\%$	
Test Methods and Remarks	BK, BKP, BKH, LK, CK, CKS, CKP, MCF Series: Temperature : $40 \pm 2^\circ\text{C}$ Humidity : 90 to 95%RH Duration : 500 +24/-0 hrs Recovery : 2 to 3 hrs of recovery under the standard condition after the removal from test chamber. (See Note 1) HK, HKQ, AQ, MCOIL™ MC series: Temperature : $60 \pm 2^\circ\text{C}$ Humidity : 90 to 95%RH Duration : 500 +24/-0 hrs Recovery : 2 to 3 hrs of recovery under the standard condition after the removal from test chamber. (See Note 1)	

(Note 1) When there are questions concerning measurement result; measurement shall be made after 48 ± 2 hrs of recovery under the standard condition.

15. Loading under Damp Heat		
Specified Value	BK series	Appearance: No significant abnormality Impedance change: Within $\pm 30\%$
	BKH series	
	BKP series	
	MCF series	—
	CK series	Appearance: No significant abnormality Inductance change: Within $\pm 20\%$
	CKS series	
	CKP series	Appearance: No significant abnormality Inductance change: Within $\pm 30\%$
	LK series	Appearance: No significant abnormality Inductance change: 1005 \Rightarrow Within $\pm 10\%$ 1608 \Rightarrow 0.047~12.0 μH : Within $\pm 10\%$ 15.0~33.0 μH : Within $\pm 15\%$ 2125 \Rightarrow Within $\pm 20\%$ Q change: Within $\pm 30\%$
	HK0603, HK1005	Appearance: No significant abnormality Inductance change: Within $\pm 10\%$ Q change: Within $\pm 20\%$
	HK1608, HK2125	
	HKQ0603	
	AQ105	
MCOIL™ MC series※	Appearance: No significant abnormality Inductance change: Within $\pm 10\%$	
Test Methods and Remarks	BK, BKP, BKH, LK, CK, CKS, CKP Series: Temperature : $40 \pm 2^\circ\text{C}$ Humidity : 90 to 95%RH Applied current : Rated current Duration : 500 +24/-0 hrs Recovery : 2 to 3 hrs of recovery under the standard condition after the removal from test chamber. (See Note 1) HK, HKQ, AQ, MCOIL™ MC Series: Temperature : $60 \pm 2^\circ\text{C}$ Humidity : 90 to 95%RH Applied current : Rated current ※MC series ; Idc2max Duration : 500 +24/-0 hrs Recovery : 2 to 3 hrs of recovery under the standard condition after the removal from test chamber. (See Note 1)	

Note on standard condition: "standard condition" referred to herein is defined as follows:

5 to 35°C of temperature, 45 to 85% relative humidity, and 86 to 106kPa of air pressure.

When there are questions concerning measurement results:

In order to provide correlation data, the test shall be conducted under condition of $20 \pm 2^\circ\text{C}$ of temperature, 60 to 70% relative humidity, and 86 to 106kPa of air pressure.

Unless otherwise specified, all the tests are conducted under the "standard condition."

(Note 1) Measurement shall be made after 48 ± 2 hrs of recovery under the standard condition.

16. Loading at High Temperature		
Specified Value	BK series	Appearance: No significant abnormality Impedance change: Within $\pm 30\%$
	BKH series	
	BKP series	
	MCF series	Appearance: No significant abnormality Impedance change: Within $\pm 20\%$
	CK series	Appearance: No significant abnormality
	CKS series	Inductance change: Within $\pm 20\%$
	CKP series	Appearance: No significant abnormality Inductance change: Within $\pm 30\%$
	LK series	Appearance: No significant abnormality Inductance change: 1005 \Rightarrow Within $\pm 10\%$ 1608 \Rightarrow 0.047~12.0 μH : Within $\pm 10\%$ 15.0~33.0 μH : Within $\pm 15\%$ 2125 \Rightarrow Within $\pm 20\%$ Q change: Within $\pm 30\%$
	HK0603, HK1005	Appearance: No significant abnormality Inductance change: Within $\pm 10\%$ Q change: Within $\pm 20\%$
	HK1608, HK2125	
	HKQ0603	
	AQ105	
MCOIL™ MC series※	Appearance: No significant abnormality Inductance change: Within $\pm 10\%$	
Test Methods and Remarks	Temperature : Maximum operating temperature Applied current : Rated current ※MC series ; Idc2max Duration : 500 +24/-0 hrs Recovery : 2 to 3 hrs of recovery under the standard condition after the removal from test chamber. (See Note 1)	

Note on standard condition: "standard condition" referred to herein is defined as follows:
5 to 35°C of temperature, 45 to 85% relative humidity, and 86 to 106kPa of air pressure.

When there are questions concerning measurement results:

In order to provide correlation data, the test shall be conducted under condition of 20 \pm 2°C of temperature, 60 to 70% relative humidity, and 86 to 106kPa of air pressure. Unless otherwise specified, all the tests are conducted under the "standard condition."

(Note 1) Measurement shall be made after 48 \pm 2 hrs of recovery under the standard condition.

Metal Multilayer Chip Power Inductors (MCOIL™ MC series)

■ PRECAUTIONS

1. Circuit Design	
Precautions	<ul style="list-style-type: none"> ◆ Operating environment <p>The products described in this specification are intended for use in general electronic equipment.(office supply equipment, telecommunications systems, measuring equipment, and household equipment). They are not intended for use in mission-critical equipment or systems requiring special quality and high reliability (traffic systems, safety equipment, aerospace systems, nuclear control systems and medical equipment including life-support systems,) where product failure might result in loss of life, injury or damage. For such uses, contact TAIYO YUDEN Sales Department in advance.</p>
2. PCB Design	
Precautions	<ul style="list-style-type: none"> ◆ Land pattern design <ul style="list-style-type: none"> • Please refer to a recommended land pattern specified.
Technical considerations	<ul style="list-style-type: none"> ◆ Land pattern design ◆ Surface Mounting <ul style="list-style-type: none"> • Mounting and soldering conditions should be checked beforehand. • Applicable soldering process to this products is reflow soldering only.
3. Considerations for automatic placement	
Precautions	<ul style="list-style-type: none"> ◆ Adjustment of mounting machine <ul style="list-style-type: none"> • Excessive impact load should not be imposed on the products when mounting onto the PC boards. • Mounting and soldering conditions should be checked beforehand.
Technical considerations	<ul style="list-style-type: none"> ◆ Adjustment of mounting machine <ul style="list-style-type: none"> • When installing products, care should be taken not to apply distortion stress as it may deform the products.
4. Soldering	
Precautions	<ul style="list-style-type: none"> ◆ Reflow soldering <ul style="list-style-type: none"> • Please contact any of our offices for a reflow soldering, and refer to the recommended condition specified. • The product shall be used reflow soldering only. • Please do not add any stress to a product until it returns in normal temperature after reflow soldering. ◆ Lead free soldering <ul style="list-style-type: none"> • When using products with lead free soldering, we request to use them after confirming adhesion, temperature of resistance to soldering heat, soldering etc sufficiently.
Technical considerations	<ul style="list-style-type: none"> ◆ Reflow soldering <ul style="list-style-type: none"> • If products are used beyond the range of the recommended conditions, heat stresses may deform the products, and consequently degrade the reliability of the products. <p style="text-align: center;">Recommended reflow condition (Pb free solder)</p> <p style="text-align: center;">Temperature [°C]</p> <p style="text-align: center;">Heating Time [sec]</p>
5. Cleaning	
Precautions	<ul style="list-style-type: none"> ◆ Cleaning conditions <ul style="list-style-type: none"> • Washing by supersonic waves shall be avoided.
Technical considerations	<ul style="list-style-type: none"> ◆ Cleaning conditions <ul style="list-style-type: none"> • If washed by supersonic waves, the products might be broken.

▶ This catalog contains the typical specification only due to the limitation of space. When you consider the purchase of our products, please check our specification. For details of each product (characteristics graph, reliability information, precautions for use, and so on), see our Web site (<http://www.ty-top.com/>).

6. Handling	
Precautions	<ul style="list-style-type: none"> ◆ Handling <ul style="list-style-type: none"> • Keep the product away from all magnets and magnetic objects. ◆ Breakaway PC boards (splitting along perforations) <ul style="list-style-type: none"> • When splitting the PC board after mounting product, care should be taken not to give any stresses of deflection or twisting to the board. • Board separation should not be done manually, but by using the appropriate devices. ◆ Mechanical considerations <ul style="list-style-type: none"> • Please do not give the product any excessive mechanical shocks. • Please do not add any shock and power to a product in transportation. ◆ Application of resin coatings, moldings, etc. to the PCB and components. <ul style="list-style-type: none"> • Please avoid operation, which apply excessive stress and/or temperature to the products such as resin molding.
Technical considerations	<ul style="list-style-type: none"> ◆ Handling <ul style="list-style-type: none"> • There is a case that a characteristic varies with magnetic influence. ◆ Breakaway PC boards (splitting along perforations) <ul style="list-style-type: none"> • The position of the product on PCBs shall be carefully considered to minimize the stress caused from splitting of the PCBs. ◆ Mechanical considerations <ul style="list-style-type: none"> • There is a case to be damaged by a mechanical shock. • There is a case to be broken by the handling in transportation. ◆ Application of resin coatings, moldings, etc. to the PCB and components. <ul style="list-style-type: none"> • Damage and a characteristic can vary with an excessive stress and/or temperature
7. Storage conditions	
Precautions	<ul style="list-style-type: none"> ◆ Storage <ul style="list-style-type: none"> • To maintain the solderability of terminal electrodes and to keep the packing material in good condition, temperature and humidity in the storage area should be controlled. Recommended conditions Ambient temperature : 0~40°C Humidity : Below 70% RH The ambient temperature must be kept below 30°C. Even under ideal storage conditions, solderability of products electrodes may decrease as time passes. For this reason, product should be used within 6 months from the time of delivery. In case of storage over 6 months, solderability shall be checked before actual usage.
Technical considerations	<ul style="list-style-type: none"> ◆ Storage <ul style="list-style-type: none"> • Under a high temperature and humidity environment, problems such as reduced solderability caused by oxidation of terminal electrodes and deterioration of taping/packaging materials may take place.

金属磁芯 SMD 功率电感器 (MCOIL™ MD 系列)



回流焊

■ 型号标示法

※使用温度范围: -40~+125°C (包含产品本身发热)

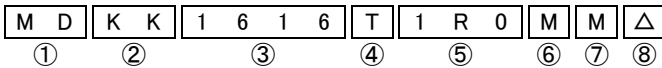

△ = 空格

① 类型

代码	类型
MD	基本金属线圈规格

② 尺寸 (H)

代码	尺寸 (H) [mm]
JE	0.95
KK	1.0
MK	1.2
PK	1.4
WK	2.0

③ 尺寸 (L×W)

代码	尺寸 (L×W) [mm]
1616	1.6 × 1.6
2020	2.0 × 2.0
3030	3.0 × 3.0
4040	4.0 × 4.0
5050	4.9 × 4.9

④ 包装

代码	包装
T	卷盘带装

⑤ 标称电感值

代码 (例)	标称电感值 [μH]
R47	0.47
1R0	1.0
4R7	4.7

※R=小数点

⑥ 电感量公差

代码	电感量公差
M	±20%
N	±30%

⑦ 个别规格

代码	个别规格
F	铁氧体外涂品
M	金属外涂品

⑧ 本公司管理记号

■ 标准外型尺寸 / 标准数量

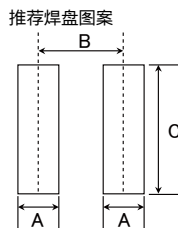
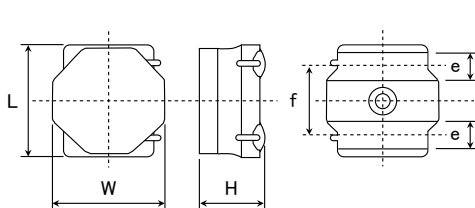

Type	A	B	C
1616	0.5	1.10	1.65
2020	0.65	1.35	2.0
3030	0.8	2.2	2.7
4040	1.2	2.8	3.7
5050	1.5	3.6	4.2

单位: mm

Type	L	W	H	e	f	标准数量 [pcs] 卷盘带装
MDKK1616	1.64±0.1 (0.065±0.004)	1.64±0.1 (0.065±0.004)	1.0 max (0.039 max)	0.40 +0.2/-0.1 (0.016 +0.008/-0.004)	1.0±0.2 (0.039±0.008)	2500
MDJE2020	2.0±0.15 (0.079±0.006)	2.0±0.15 (0.079±0.006)	0.95 max (0.037 max)	0.50±0.2 (0.02±0.008)	1.25±0.2 (0.049±0.008)	2500
MDKK2020	2.0±0.15 (0.079±0.006)	2.0±0.15 (0.079±0.006)	1.0 max (0.039 max)	0.50±0.2 (0.02±0.008)	1.25±0.2 (0.049±0.008)	2500
MDMK2020	2.0±0.15 (0.079±0.006)	2.0±0.15 (0.079±0.006)	1.2 max (0.047 max)	0.50±0.2 (0.02±0.008)	1.25±0.2 (0.049±0.008)	2500
MDKK3030	3.0±0.1 (0.118±0.004)	3.0±0.1 (0.118±0.004)	1.0 max (0.039 max)	0.90±0.2 (0.035±0.008)	1.9±0.2 (0.075±0.008)	2000
MDMK3030	3.0±0.1 (0.118±0.004)	3.0±0.1 (0.118±0.004)	1.2 max (0.047 max)	0.90±0.2 (0.035±0.008)	1.9±0.2 (0.075±0.008)	2000
MDJE4040	4.0±0.2 (0.157±0.008)	4.0±0.2 (0.157±0.008)	0.95 max (0.037 max)	1.1±0.2 (0.043±0.008)	2.5±0.2 (0.098±0.008)	1000
MDMK4040	4.0±0.2 (0.157±0.008)	4.0±0.2 (0.157±0.008)	1.2 max (0.047 max)	1.1±0.2 (0.043±0.008)	2.5±0.2 (0.098±0.008)	1000
MDWK4040	4.0±0.2 (0.157±0.008)	4.0±0.2 (0.157±0.008)	2.0 max (0.079 max)	1.1±0.2 (0.043±0.008)	2.5±0.2 (0.098±0.008)	700
MDPK5050	4.9±0.2 (0.193±0.008)	4.9±0.2 (0.193±0.008)	1.4 max (0.055 max)	1.20±0.2 (0.047±0.008)	3.3±0.2 (0.130±0.008)	1000

单位: mm (inch)

▶ 由于篇幅有限, 本产品目录中只记载了有代表性的产品规格, 若考虑使用弊公司产品时, 请确认交货规格说明书中的详细规格。另外, 有关各产品的详细信息(特性图、可靠性信息、使用时的注意事项等), 请参阅弊网站(<http://www.ty-top.com/>)。

●MDKK1616型 【厚度:1.0mm max.】

型号	EHS	标称电感值 [μH]	电感量公差	直流电阻 [Ω]		额定电流 ※) [mA]				测试频率 [MHz]
						直流重叠允许电流:I _{dc1}		温度上升允许电流:I _{dc2}		
						Max.	Typ.	Max.	Typ.	
MDKK1616TR47MM	RoHS	0.47	±20%	0.095	0.080	3,300	4,100	1,500	1,780	1
MDKK1616T1R0MM	RoHS	1.0	±20%	0.140	0.120	2,200	2,750	1,200	1,490	1
MDKK1616T1R5MM	RoHS	1.5	±20%	0.185	0.160	1,750	2,200	1,100	1,330	1
MDKK1616T2R2MM	RoHS	2.2	±20%	0.250	0.215	1,500	1,800	950	1,110	1
MDKK1616T3R3MM	RoHS	3.3	±20%	0.515	0.450	1,150	1,450	650	730	1
MDKK1616T4R7MM	RoHS	4.7	±20%	0.640	0.550	950	1,200	550	630	1
MDKK1616T6R8MM	RoHS	6.8	±20%	0.820	0.710	630	880	520	600	1
MDKK1616T100MM	RoHS	10	±20%	1.120	0.970	550	800	450	500	1
MDKK1616T150MM	RoHS	15	±20%	1.800	1.600	460	640	400	440	1

●MDJE2020型 【厚度:0.95mm max.】

型号	EHS	标称电感值 [μH]	电感量公差	直流电阻 [Ω]		额定电流 ※) [mA]				测试频率 [MHz]
						直流重叠允许电流:I _{dc1}		温度上升允许电流:I _{dc2}		
						Max.	Typ.	Max.	Typ.	
MDJE2020T1R0MM	RoHS	1.0	±20%	0.121	0.106	3,100	3,800	1,550	1,800	1
MDJE2020T2R2MM	RoHS	2.2	±20%	0.266	0.230	1,550	1,900	1,050	1,200	1
MDJE2020T3R3MM	RoHS	3.3	±20%	0.340	0.290	1,350	1,600	950	1,100	1
MDJE2020T4R7MM	RoHS	4.7	±20%	0.475	0.410	1,200	1,550	850	950	1
MDJE2020T6R8MM	RoHS	6.8	±20%	0.630	0.550	800	1,100	750	850	1
MDJE2020T100MM	RoHS	10	±20%	1.040	0.910	700	900	550	600	1

●MDKK2020型 【厚度:1.0mm max.】

型号	EHS	标称电感值 [μH]	电感量公差	直流电阻 [Ω]		额定电流 ※) [mA]				测试频率 [MHz]
						直流重叠允许电流:I _{dc1}		温度上升允许电流:I _{dc2}		
						Max.	Typ.	Max.	Typ.	
MDKK2020TR47MM	RoHS	0.47	±20%	0.046	0.040	3,500	4,150	2,200	2,500	1
MDKK2020TR68MM	RoHS	0.68	±20%	0.060	0.052	3,200	3,650	2,000	2,100	1
MDKK2020T1R0MM	RoHS	1.0	±20%	0.085	0.074	2,900	3,400	1,700	1,900	1
MDKK2020T1R5MM	RoHS	1.5	±20%	0.133	0.115	1,900	2,250	1,350	1,500	1
MDKK2020T2R2MM	RoHS	2.2	±20%	0.165	0.139	1,650	1,950	1,200	1,350	1
MDKK2020T3R3MM	RoHS	3.3	±20%	0.275	0.240	1,300	1,550	940	1,050	1
MDKK2020T4R7MM	RoHS	4.7	±20%	0.435	0.375	1,050	1,250	750	850	1
MDKK2020T100MM	RoHS	10	±20%	0.690	0.600	750	900	630	680	1
MDKK2020T150MM	RoHS	15	±20%	1.180	1.020	550	750	480	550	1

●MDMK2020型 【厚度:1.2mm max.】

型号	EHS	标称电感值 [μH]	电感量公差	直流电阻 [Ω]		额定电流 ※) [mA]				测试频率 [MHz]
						直流重叠允许电流:I _{dc1}		温度上升允许电流:I _{dc2}		
						Max.	Typ.	Max.	Typ.	
MMDK2020TR47MM	RoHS	0.47	±20%	0.046	0.040	4,200	4,800	2,300	2,450	1
MMDK2020TR68MM	RoHS	0.68	±20%	0.058	0.050	3,500	4,100	2,000	2,200	1
MMDK2020T1R0MM	RoHS	1.0	±20%	0.064	0.056	2,550	2,900	1,900	2,050	1
MMDK2020T1R5MM	RoHS	1.5	±20%	0.086	0.075	2,000	2,300	1,650	1,750	1
MMDK2020T2R2MM	RoHS	2.2	±20%	0.109	0.095	1,750	2,000	1,450	1,550	1
MMDK2020T3R3MM	RoHS	3.3	±20%	0.178	0.155	1,350	1,550	1,150	1,200	1
MMDK2020T4R7MM	RoHS	4.7	±20%	0.242	0.210	1,150	1,300	950	1,050	1

●MDKK3030型 【厚度:1.0mm max.】

型号	EHS	标称电感值 [μH]	电感量公差	直流电阻 [Ω]		额定电流 ※) [mA]				测试频率 [MHz]
						直流重叠允许电流:I _{dc1}		温度上升允许电流:I _{dc2}		
						Max.	Typ.	Max.	Typ.	
MDKK3030TR47MM	RoHS	0.47	±20%	0.039	0.033	5,400	6,500	3,900	4,500	1
MDKK3030T1R0MM	RoHS	1.0	±20%	0.086	0.074	4,400	5,200	2,400	2,800	1
MDKK3030T1R5MM	RoHS	1.5	±20%	0.100	0.087	3,000	3,500	2,100	2,400	1
MDKK3030T2R2MM	RoHS	2.2	±20%	0.144	0.125	2,500	3,000	1,900	2,200	1
MDKK3030T3R3MM	RoHS	3.3	±20%	0.248	0.215	2,000	2,400	1,350	1,500	1
MDKK3030T4R7MM	RoHS	4.7	±20%	0.345	0.300	1,700	2,000	1,150	1,300	1
MDKK3030T6R8MM	RoHS	6.8	±20%	0.437	0.380	1,400	1,700	1,000	1,150	1
MDKK3030T100MM	RoHS	10	±20%	0.575	0.500	1,100	1,300	850	1,000	1

●MDMK3030型 【厚度:1.2mm max.】

型号	EHS	标称电感值 [μH]	电感量公差	直流电阻 [Ω]		额定电流 ※) [mA]				测试频率 [MHz]
						直流重叠允许电流:I _{dc1}		温度上升允许电流:I _{dc2}		
						Max.	Typ.	Max.	Typ.	
MMDK3030TR30MM	RoHS	0.30	±20%	0.020	0.017	7,600	9,200	5,500	6,400	1
MMDK3030TR33MM	RoHS	0.33	±20%	0.020	0.017	6,400	8,700	5,500	6,400	1
MMDK3030TR47MM	RoHS	0.47	±20%	0.027	0.023	6,300	7,500	4,700	5,500	1
MMDK3030T1R0MM	RoHS	1.0	±20%	0.050	0.043	4,300	5,100	3,300	3,900	1
MMDK3030T1R5MM	RoHS	1.5	±20%	0.074	0.064	3,400	4,100	2,500	3,000	1
MMDK3030T2R2MM	RoHS	2.2	±20%	0.112	0.097	2,800	3,600	2,100	2,400	1
MMDK3030T3R3MM	RoHS	3.3	±20%	0.167	0.145	2,100	2,700	1,650	1,900	1
MMDK3030T4R7MM	RoHS	4.7	±20%	0.263	0.228	1,800	2,300	1,350	1,550	1

▶由于篇幅有限,本产品目录中只记载了有代表性的产品规格,若考虑使用弊公司产品时,请确认交货规格说明书中的详细规格。另外,有关各产品的详细信息(特性图、可靠性信息、使用时的注意事项等),请参阅弊公司网站(<http://www.ty-top.com/>)。

● MDJE4040 型 【厚度:0.95mm max.】

型号	EHS	标称电感值 [μH]	电感量公差	直流电阻 [Ω]		额定电流 ※) [mA]				测试频率 [MHz]
						直流重叠允许电流:Idc1		温度上升允许电流:Idc2		
						Max.	Typ.	Max.	Typ.	
MDJE4040TR47MM	RoHS	0.47	±20%	0.040	0.035	6,000	7,900	4,000	4,500	1
MDJE4040T1R0MM	RoHS	1.0	±20%	0.069	0.060	4,700	5,700	3,000	3,500	1
MDJE4040T1R5MM	RoHS	1.5	±20%	0.084	0.073	3,000	4,000	2,700	3,100	1
MDJE4040T2R2MM	RoHS	2.2	±20%	0.115	0.100	2,400	3,100	2,400	2,700	1
MDJE4040T3R3MM	RoHS	3.3	±20%	0.200	0.175	2,000	2,600	1,800	2,000	1
MDJE4040T4R7MM	RoHS	4.7	±20%	0.250	0.220	1,900	2,300	1,600	1,900	1
MDJE4040T6R8MM	RoHS	6.8	±20%	0.370	0.320	1,500	1,800	1,300	1,500	1
MDJE4040T100MM	RoHS	10	±20%	0.510	0.440	1,400	1,700	1,100	1,300	1

● MDMK4040F 型 【厚度:1.2mm max.】

型号	EHS	标称电感值 [μH]	电感量公差	直流电阻 [Ω]		额定电流 ※) [mA]				测试频率 [kHz]
						直流重叠允许电流:Idc1		温度上升允许电流:Idc2		
						Max.	Typ.	Max.	Typ.	
MDMK4040TR47MF	RoHS	0.47	±20%	0.029	0.025	7,500	10,000	4,600	5,400	100
MDMK4040T1R0MF	RoHS	1.0	±20%	0.047	0.041	5,200	7,500	3,500	4,200	100
MDMK4040T1R2MF	RoHS	1.2	±20%	0.047	0.041	4,200	6,200	3,500	4,200	100
MDMK4040T1R5MF	RoHS	1.5	±20%	0.065	0.056	3,700	5,400	3,300	3,600	100
MDMK4040T2R2MF	RoHS	2.2	±20%	0.092	0.080	3,200	4,500	2,500	2,900	100

● MDMK4040 型 【厚度:1.2mm max.】

型号	EHS	标称电感值 [μH]	电感量公差	直流电阻 [Ω]		额定电流 ※) [mA]				测试频率 [MHz]
						直流重叠允许电流:Idc1		温度上升允许电流:Idc2		
						Max.	Typ.	Max.	Typ.	
MDMK4040TR68MM	RoHS	0.68	±20%	0.029	0.025	6,700	7,800	5,000	5,700	1
MDMK4040T1R0MM	RoHS	1.0	±20%	0.036	0.031	5,000	6,200	4,500	5,100	1
MDMK4040T1R5MM	RoHS	1.5	±20%	0.065	0.056	4,500	5,600	3,200	3,600	1
MDMK4040T2R2MM	RoHS	2.2	±20%	0.079	0.069	3,800	4,500	2,800	3,200	1
MDMK4040T3R3MM	RoHS	3.3	±20%	0.130	0.113	3,200	4,000	2,200	2,500	1
MDMK4040T4R7MM	RoHS	4.7	±20%	0.160	0.140	2,500	3,000	1,900	2,200	1
MDMK4040T6R8MM	RoHS	6.8	±20%	0.230	0.200	1,900	2,200	1,600	1,800	1
MDMK4040T100MM	RoHS	10	±20%	0.330	0.280	1,700	2,000	1,400	1,600	1

● MDWK4040 型 【厚度:2.0mm max.】

型号	EHS	标称电感值 [μH]	电感量公差	直流电阻 [Ω]		额定电流 ※) [mA]				测试频率 [MHz]
						直流重叠允许电流:Idc1		温度上升允许电流:Idc2		
						Max.	Typ.	Max.	Typ.	
MDWK4040TR33NM	RoHS	0.33	±30%	0.013	0.011	16,000	21,000	7,800	8,800	1
MDWK4040TR47NM	RoHS	0.47	±30%	0.013	0.011	10,000	15,000	7,800	8,800	1
MDWK4040TR56NM	RoHS	0.56	±30%	0.016	0.014	9,000	13,000	6,500	7,500	1
MDWK4040TR68MM	RoHS	0.68	±20%	0.016	0.014	8,000	12,000	7,300	8,300	1
MDWK4040T1R0MM	RoHS	1.0	±20%	0.027	0.023	7,000	9,400	5,100	5,800	1
MDWK4040T1R5MM	RoHS	1.5	±20%	0.041	0.035	7,000	9,400	4,100	4,700	1
MDWK4040T2R2MM	RoHS	2.2	±20%	0.054	0.047	5,400	7,500	3,500	4,000	1
MDWK4040T3R3MM	RoHS	3.3	±20%	0.075	0.066	3,700	5,200	3,000	3,300	1
MDWK4040T4R7MM	RoHS	4.7	±20%	0.107	0.093	3,500	5,000	2,500	2,800	1
MDWK4040T6R8MM	RoHS	6.8	±20%	0.158	0.138	2,900	4,000	2,000	2,300	1
MDWK4040T100MM	RoHS	10	±20%	0.194	0.169	2,200	3,100	1,600	1,900	1
MDWK4040T220MM	RoHS	22	±20%	0.460	0.400	1,500	2,100	1,200	1,400	1
MDWK4040T330MM	RoHS	33	±20%	0.720	0.625	1,200	1,700	800	1,000	1

● MDPK5050 型 【厚度:1.4mm max.】

型号	EHS	标称电感值 [μH]	电感量公差	直流电阻 [Ω]		额定电流 ※) [mA]				测试频率 [MHz]
						直流重叠允许电流:Idc1		温度上升允许电流:Idc2		
						Max.	Typ.	Max.	Typ.	
MDPK5050T1R0MM	RoHS	1.0	±20%	0.040	0.034	8,500	10,000	4,300	4,700	1
MDPK5050T2R2MM	RoHS	2.2	±20%	0.055	0.047	4,100	5,000	3,600	4,200	1
MDPK5050T3R3MM	RoHS	3.3	±20%	0.086	0.073	3,800	4,500	2,900	3,400	1
MDPK5050T4R7MM	RoHS	4.7	±20%	0.102	0.088	3,500	4,200	2,500	3,000	1
MDPK5050T6R8MM	RoHS	6.8	±20%	0.138	0.12	2,700	3,200	2,200	2,500	1
MDPK5050T100MM	RoHS	10	±20%	0.225	0.19	2,200	2,600	1,700	2,000	1

※)直流重叠允许电流 (Idc1)为直流重叠带来的电感值下降, 范围在30%以内的直流电感值 (at 20°C)

※)温度上升允许电流 (Idc2)为温度上升到40°C时的直流电感值 (at 20°C)

※)最大额定电流值为能够满足直流重叠允许电流和温度上升允许电流的直流电流值

METAL CORE SMD POWER INDUCTORS (MCOIL™ MD SERIES)

PACKAGING

① Minimum Quantity

Type	Standard Quantity [pcs]
	Tape & Reel
MDKK1616	2500
MDJE2020	2500
MDKK2020	
MDMK2020	
MDKK3030	2000
MDMK3030	
MDJE4040	1000
MDMK4040	
MDWK4040	700
MDPK5050	1000

② Tape Material

● Embossed Tape

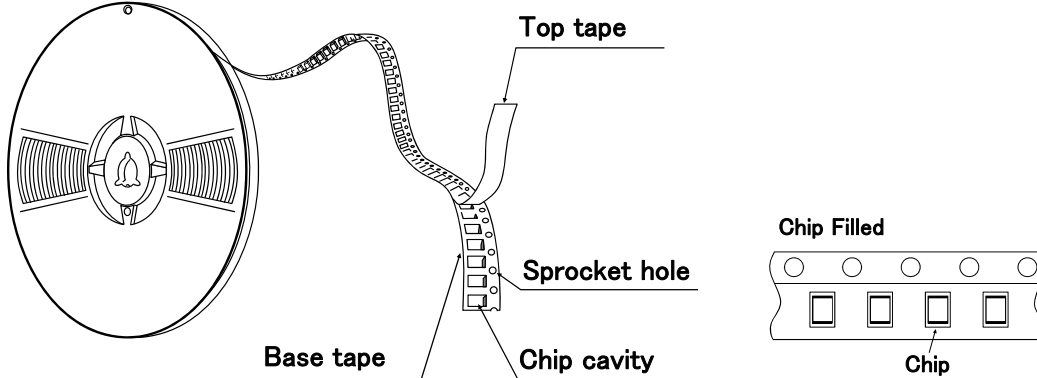

③ Taping dimensions

● Embossed tape 8mm wide (0.315 inches wide)

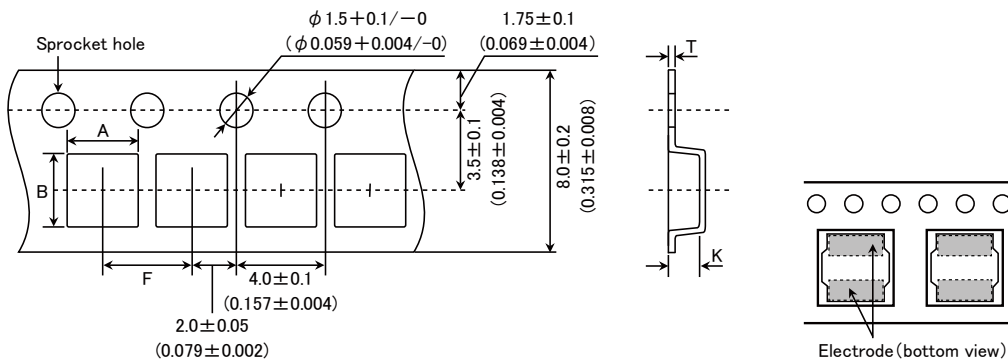

Type	Chip cavity		Insertion pitch	Tape thickness	
	A	B		T	K
MDKK1616	1.79 ± 0.1 (0.071 ± 0.004)	1.79 ± 0.1 (0.071 ± 0.004)	4.0 ± 0.1 (0.157 ± 0.004)	0.25 ± 0.05 (0.010 ± 0.002)	1.1 ± 0.1 (0.043 ± 0.004)
MDJE2020	2.2 ± 0.1 (0.102 ± 0.004)	2.2 ± 0.1 (0.102 ± 0.004)	4.0 ± 0.1 (0.157 ± 0.004)	0.25 ± 0.05 (0.009 ± 0.002)	1.3 ± 0.1 (0.051 ± 0.004)
MDKK2020					
MDMK2020					
MDKK3030	3.2 ± 0.1 (0.126 ± 0.004)	3.2 ± 0.1 (0.126 ± 0.004)	4.0 ± 0.1 (0.157 ± 0.004)	0.3 ± 0.05 (0.012 ± 0.002)	1.4 ± 0.1 (0.055 ± 0.004)
MDMK3030					

Unit: mm (inch)

▶ This catalog contains the typical specification only due to the limitation of space. When you consider the purchase of our products, please check our specification. For details of each product (characteristics graph, reliability information, precautions for use, and so on), see our Web site (<http://www.ty-top.com/>).

● Embossed tape 12mm wide (0.47 inches wide)

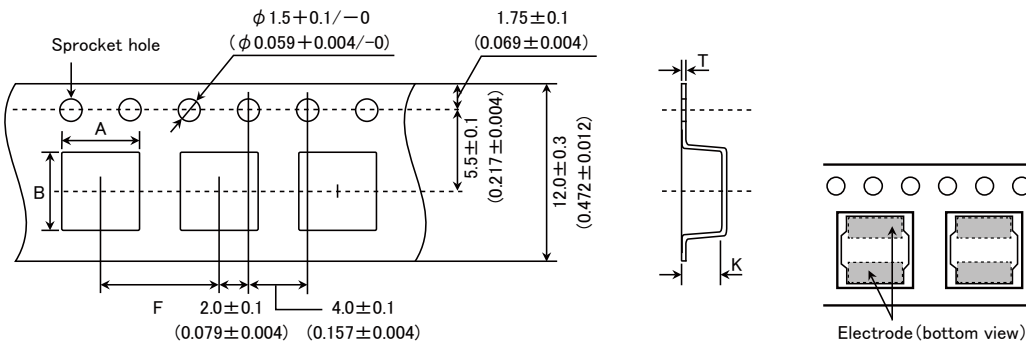

Type	Chip cavity		Insertion pitch F	Tape thickness	
	A	B		T	K
MDJE4040	4.3 ± 0.1 (0.169 ± 0.004)	4.3 ± 0.1 (0.169 ± 0.004)	8.0 ± 0.1 (0.315 ± 0.004)	0.3 ± 0.1 (0.012 ± 0.004)	1.6 ± 0.1 (0.063 ± 0.004)
MDMK4040					
MDWK4040					
MDPK5050	5.25 ± 0.1 (0.207 ± 0.004)	5.25 ± 0.1 (0.207 ± 0.004)	8.0 ± 0.1 (0.315 ± 0.004)	0.3 ± 0.1 (0.012 ± 0.004)	1.6 ± 0.1 (0.063 ± 0.004)

Unit : mm (inch)

④ Leader and Blank portion

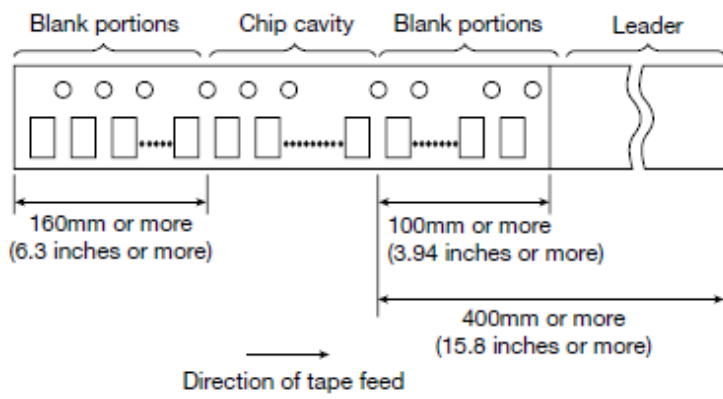

⑤ Reel size

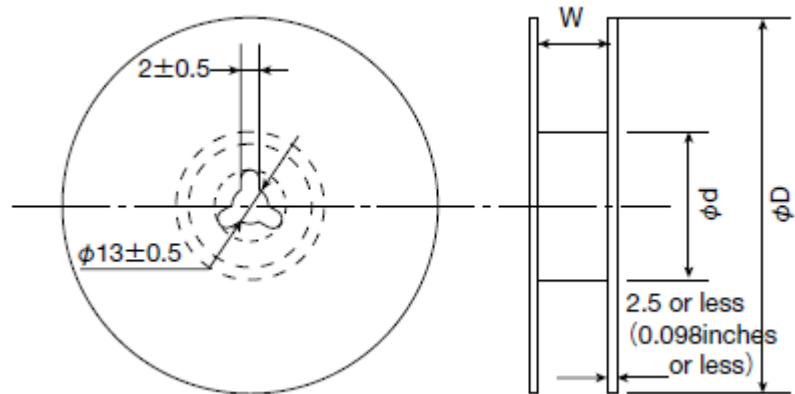

Type	Reel size (Reference values)		
	ϕD	ϕd	W
MDKK1616	180 ± 0.5 (7.087 ± 0.019)	60 ± 1.0 (2.36 ± 0.04)	10.0 ± 1.5 (0.394 ± 0.059)
MDJE2020			
MDKK2020			
MDMK2020			
MDKK3030	180 ± 3.0 (7.087 ± 0.118)	60 ± 2.0 (2.36 ± 0.08)	14.0 ± 1.5 (0.551 ± 0.059)
MDMK3030			
MDJE4040			
MDMK4040			
MDWK4040			
MDPK5050			

Unit : mm (inch)

▶ This catalog contains the typical specification only due to the limitation of space. When you consider the purchase of our products, please check our specification. For details of each product (characteristics graph, reliability information, precautions for use, and so on), see our Web site (<http://www.ty-top.com/>).

⑥ Top Tape Strength

Top tape strength

Type	Peel-off strength
MDKK1616	0.1N~1.0N
MDJE2020	
MDKK2020	
MDMK2020	
MDKK3030	0.1N~1.3N
MDMK3030	
MDJE4040	
MDMK4040	
MDWK4040	
MDPK5050	

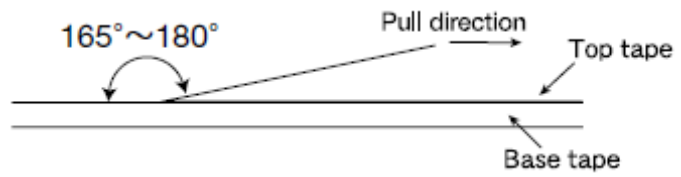

METAL CORE SMD POWER INDUCTORS (MCOIL™ MD SERIES)

RELIABILITY DATA

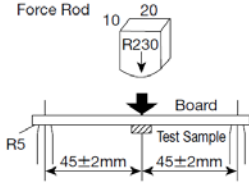
1. Operating Temperature Range		
Specified Value	MD series	-40~+125°C
Test Methods and Remarks	Including self-generated heat	
2. Storage Temperature Range		
Specified Value	MD series	-40~+85°C
Test Methods and Remarks	-5 to 40°C for the product with taping.	
3. Rated current		
Specified Value	MD series	Within the specified tolerance
4. Inductance		
Specified Value	MD series	Within the specified tolerance
Test Methods and Remarks	Measuring equipment : LCR Meter (HP 4285A or equivalent) Measuring condition : Please see item list.	
5. DC Resistance		
Specified Value	MD series	Within the specified tolerance
Test Methods and Remarks	Measuring equipment : DC ohmmeter (HIOKI 3227 or equivalent)	
6. Self resonance frequency		
Specified Value	MD series	—
7. Temperature characteristic		
Specified Value	MD series	Inductance change : Within ±10%
Test Methods and Remarks	Measurement of inductance shall be taken at temperature range within -40°C~+125°C. With reference to inductance value at +20°C., change rate shall be calculated.	
8. Resistance to flexure of substrate		
Specified Value	MD series	No damage
Test Methods and Remarks	The test samples shall be soldered to the test board by the reflow. As illustrated below, apply force in the direction of the arrow indicating until deflection of the test board reaches to 2 mm. Test board size : 100×40×1.0 mm Test board material : Glass epoxy-resin Solder cream thickness : 0.10 mm	
		
9. Insulation resistance : between wires		
Specified Value	MD series	—
10. Insulation resistance : between wire and core		
Specified Value	MD series	—
11. Withstanding voltage : between wire and core		
Specified Value	MD series	—

▶ This catalog contains the typical specification only due to the limitation of space. When you consider the purchase of our products, please check our specification. For details of each product (characteristics graph, reliability information, precautions for use, and so on), see our Web site (<http://www.ty-top.com/>).

12. Adhesion of terminal electrode		
Specified Value	MD series	Shall not come off PC board
Test Methods and Remarks	The test samples shall be soldered to the test board by the reflow. Applied force : 10N to X and Y directions. Duration : 5s. Solder cream thickness : 0.10mm.	

13. Resistance to vibration																
Specified Value	MD series	Inductance change : Within $\pm 10\%$ No significant abnormality in appearance.														
Test Methods and Remarks	The test samples shall be soldered to the test board by the reflow. Then it shall be submitted to below test conditions. <table border="1" style="margin-left: 20px;"> <tr> <td>Frequency Range</td> <td colspan="2">10~55Hz</td> </tr> <tr> <td>Total Amplitude</td> <td colspan="2">1.5mm (May not exceed acceleration 196m/s²)</td> </tr> <tr> <td>Sweeping Method</td> <td colspan="2">10Hz to 55Hz to 10Hz for 1min.</td> </tr> <tr> <td rowspan="3">Time</td> <td>X</td> <td rowspan="3">For 2 hours on each X, Y, and Z axis.</td> </tr> <tr> <td>Y</td> </tr> <tr> <td>Z</td> </tr> </table> Recovery : At least 2hrs of recovery under the standard condition after the test, followed by the measurement within 48hrs.		Frequency Range	10~55Hz		Total Amplitude	1.5mm (May not exceed acceleration 196m/s ²)		Sweeping Method	10Hz to 55Hz to 10Hz for 1min.		Time	X	For 2 hours on each X, Y, and Z axis.	Y	Z
Frequency Range	10~55Hz															
Total Amplitude	1.5mm (May not exceed acceleration 196m/s ²)															
Sweeping Method	10Hz to 55Hz to 10Hz for 1min.															
Time	X	For 2 hours on each X, Y, and Z axis.														
	Y															
	Z															

14. Solderability						
Specified Value	MD series	At least 90% of surface of terminal electrode is covered by new solder.				
Test Methods and Remarks	The test samples shall be dipped in flux, and then immersed in molten solder as shown in below table. Flux : Methanol solution containing rosin 25%. <table border="1" style="margin-left: 20px;"> <tr> <td>Solder Temperature</td> <td>245\pm5$^{\circ}$C</td> </tr> <tr> <td>Time</td> <td>5\pm1.0 sec.</td> </tr> </table> ※Immersion depth : All sides of mounting terminal shall be immersed.		Solder Temperature	245 \pm 5 $^{\circ}$ C	Time	5 \pm 1.0 sec.
Solder Temperature	245 \pm 5 $^{\circ}$ C					
Time	5 \pm 1.0 sec.					

15. Resistance to soldering heat		
Specified Value	MD series	Inductance change : Within $\pm 10\%$ No significant abnormality in appearance.
Test Methods and Remarks	The test sample shall be exposed to reflow oven at 230 \pm 5 $^{\circ}$ C for 40 seconds, with peak temperature at 260 \pm 5 $^{\circ}$ C for 5 seconds, 2 times. Test board material : Glass epoxy-resin Test board thickness : 1.0mm	

16. Thermal shock																				
Specified Value	MD series	Inductance change : Within $\pm 10\%$ No significant abnormality in appearance.																		
Test Methods and Remarks	The test samples shall be soldered to the test board by the reflow. The test samples shall be placed at specified temperature for specified time by step 1 to step 4 as shown in below table in sequence. The temperature cycle shall be repeated 100 cycles. <table border="1" style="margin-left: 20px;"> <thead> <tr> <th colspan="3">Conditions of 1 cycle</th> </tr> <tr> <th>Step</th> <th>Temperature ($^{\circ}$C)</th> <th>Duration (min)</th> </tr> </thead> <tbody> <tr> <td>1</td> <td>-40\pm3</td> <td>30\pm3</td> </tr> <tr> <td>2</td> <td>Room temperature</td> <td>Within 3</td> </tr> <tr> <td>3</td> <td>+85\pm2</td> <td>30\pm3</td> </tr> <tr> <td>4</td> <td>Room temperature</td> <td>Within 3</td> </tr> </tbody> </table>		Conditions of 1 cycle			Step	Temperature ($^{\circ}$ C)	Duration (min)	1	-40 \pm 3	30 \pm 3	2	Room temperature	Within 3	3	+85 \pm 2	30 \pm 3	4	Room temperature	Within 3
Conditions of 1 cycle																				
Step	Temperature ($^{\circ}$ C)	Duration (min)																		
1	-40 \pm 3	30 \pm 3																		
2	Room temperature	Within 3																		
3	+85 \pm 2	30 \pm 3																		
4	Room temperature	Within 3																		

17. Damp heat								
Specified Value	MD series	Inductance change : Within $\pm 10\%$ No significant abnormality in appearance.						
Test Methods and Remarks	The test samples shall be soldered to the test board by the reflow. The test samples shall be placed in thermostatic oven set at specified temperature and humidity as shown in below table. <table border="1" style="margin-left: 20px;"> <tr> <td>Temperature</td> <td>60\pm2$^{\circ}$C</td> </tr> <tr> <td>Humidity</td> <td>90~95%RH</td> </tr> <tr> <td>Time</td> <td>500+24/-0 hour</td> </tr> </table>		Temperature	60 \pm 2 $^{\circ}$ C	Humidity	90~95%RH	Time	500+24/-0 hour
Temperature	60 \pm 2 $^{\circ}$ C							
Humidity	90~95%RH							
Time	500+24/-0 hour							

18. Loading under damp heat		
Specified Value	MD series	Inductance change : Within $\pm 10\%$ No significant abnormality in appearance.
Test Methods and Remarks	The test samples shall be soldered to the test board by the reflow. The test samples shall be placed in thermostatic oven set at specified temperature and humidity and applied the rated current continuously as shown in below table.	
	Temperature	$60 \pm 2^\circ\text{C}$
	Humidity	90~95%RH
	Applied current	Rated current
	Time	500+24/-0 hour
19. Low temperature life test		
Specified Value	MD series	Inductance change : Within $\pm 10\%$ No significant abnormality in appearance.
Test Methods and Remarks	The test samples shall be soldered to the test board by the reflow. After that, the test samples shall be placed at test conditions as shown in below table.	
	Temperature	$-40 \pm 2^\circ\text{C}$
	Time	500+24/-0 hour
20. High temperature life test		
Specified Value	MD series	—
21. Loading at high temperature life test		
Specified Value	MD series	Inductance change : Within $\pm 10\%$ No significant abnormality in appearance.
Test Methods and Remarks	The test samples shall be soldered to the test board by the reflow. The test samples shall be placed in thermostatic oven set at specified temperature and applied the rated current continuously as shown in below table.	
	Temperature	$85 \pm 2^\circ\text{C}$
	Applied current	Rated current
	Time	500+24/-0 hour
22. Standard condition		
Specified Value	MD series	Standard test condition : Unless otherwise specified, temperature is $20 \pm 15^\circ\text{C}$ and $65 \pm 20\%$ of relative humidity. When there is any question concerning measurement result: In order to provide correlation data, the test shall be condition of $20 \pm 2^\circ\text{C}$ of temperature, $65 \pm 5\%$ relative humidity. Inductance is in accordance with our measured value.

METAL CORE SMD POWER INDUCTORS (MCOIL™ MD SERIES)

PRECAUTIONS

1. Circuit Design	
Precautions	<ul style="list-style-type: none"> ◆ Operating environment 1. The products described in this specification are intended for use in general electronic equipment, (office supply equipment, telecommunications systems, measuring equipment, and household equipment). They are not intended for use in mission-critical equipment or systems requiring special quality and high reliability (traffic systems, safety equipment, aerospace systems, nuclear control systems and medical equipment including life-support systems,) where product failure might result in loss of life, injury or damage. For such uses, contact TAIYO YUDEN Sales Department in advance.
2. PCB Design	
Precautions	<ul style="list-style-type: none"> ◆ Land pattern design 1. Please refer to a recommended land pattern.
Technical considerations	<ul style="list-style-type: none"> ◆ Land pattern design Surface Mounting <ul style="list-style-type: none"> • Mounting and soldering conditions should be checked beforehand. • Applicable soldering process to this products is reflow soldering only.
3. Considerations for automatic placement	
Precautions	<ul style="list-style-type: none"> ◆ Adjustment of mounting machine 1. Excessive impact load should not be imposed on the products when mounting onto the PC boards. 2. Mounting and soldering conditions should be checked beforehand.
Technical considerations	<ul style="list-style-type: none"> ◆ Adjustment of mounting machine 1. When installing products, care should be taken not to apply distortion stress as it may deform the products.
4. Soldering	
Precautions	<ul style="list-style-type: none"> ◆ Reflow soldering 1. Please contact any of our offices for a reflow soldering, and refer to the recommended condition specified. 2. The product shall be used reflow soldering only. 3. Please do not add any stress to a product until it returns in normal temperature after reflow soldering. ◆ Lead free soldering 1. When using products with lead free soldering, we request to use them after confirming adhesion, temperature of resistance to soldering heat, soldering etc sufficiently. ◆ Recommended conditions for using a soldering iron (NR10050 Type) <ul style="list-style-type: none"> • Put the soldering iron on the land-pattern. • Soldering iron's temperature - Below 350°C • Duration - 3 seconds or less • The soldering iron should not directly touch the inductor.
Technical considerations	<ul style="list-style-type: none"> ◆ Reflow soldering 1. If products are used beyond the range of the recommended conditions, heat stresses may deform the products, and consequently degrade the reliability of the products. <ul style="list-style-type: none"> • NR30/40/50/60/80, NRV20/30, NRH24/30, NRS20/40/50/60/80 Type, NR10050 Type, NS101/125 Type <p style="margin-left: 20px;">Recommended reflow condition (Pb free solder)</p> <p style="margin-left: 20px;">Temperature [°C]</p> <p style="margin-left: 20px;">Heating Time [sec]</p>
5. Cleaning	
Precautions	<ul style="list-style-type: none"> ◆ Cleaning conditions 1. Washing by supersonic waves shall be avoided.
Technical considerations	<ul style="list-style-type: none"> ◆ Cleaning conditions 1. If washed by supersonic waves, the products might be broken.

▶ This catalog contains the typical specification only due to the limitation of space. When you consider the purchase of our products, please check our specification. For details of each product (characteristics graph, reliability information, precautions for use, and so on), see our Web site (<http://www.ty-top.com/>).

6. Handling	
Precautions	<ul style="list-style-type: none"> ◆ Handling <ol style="list-style-type: none"> 1. Keep the product away from all magnets and magnetic objects. ◆ Breakaway PC boards (splitting along perforations) <ol style="list-style-type: none"> 1. When splitting the PC board after mounting product, care should be taken not to give any stresses of deflection or twisting to the board. 2. Board separation should not be done manually, but by using the appropriate devices. ◆ Mechanical considerations <ol style="list-style-type: none"> 1. Please do not give the product any excessive mechanical shocks. 2. Please do not add any shock and power to a product in transportation. ◆ Pick-up pressure <ol style="list-style-type: none"> 1. Please do not push to add any pressure to a winding part. Please do not give any shock and push into a ferrite core exposure part. ◆ Packing <ol style="list-style-type: none"> 1. Please avoid accumulation of a packing box as much as possible. ◆ Board mounting <ol style="list-style-type: none"> 1. There shall be no pattern or via between terminals at the bottom of product. 2. Components which are located in peripheral of product shall not make contact with surface (top, side) of product.
Technical considerations	<ul style="list-style-type: none"> ◆ Handling <ol style="list-style-type: none"> 1. There is a case that a characteristic varies with magnetic influence. ◆ Breakaway PC boards (splitting along perforations) <ol style="list-style-type: none"> 1. The position of the product on PCBs shall be carefully considered to minimize the stress caused from splitting of the PCBs. ◆ Mechanical considerations <ol style="list-style-type: none"> 1. There is a case to be damaged by a mechanical shock. 2. There is a case to be broken by the handling in transportation. ◆ Pick-up pressure <ol style="list-style-type: none"> 1. Damage and a characteristic can vary with an excessive shock or stress. ◆ Packing <ol style="list-style-type: none"> 1. If packing boxes are accumulated, that could cause a deformation on packing tapes or a damage on the products. ◆ Board mounting <ol style="list-style-type: none"> 1. If there is pattern or via between terminals at the bottom of product, it may cause characteristics change. 2. If components which are located in peripheral of product make contact with surface (top, side) of product, it may cause damage or characteristics change.

7. Storage conditions	
Precautions	<ul style="list-style-type: none"> ◆ Storage <ol style="list-style-type: none"> 1. To maintain the solderability of terminal electrodes and to keep the packing material in good condition, temperature and humidity in the storage area should be controlled. <ul style="list-style-type: none"> ▪ Recommended conditions <ul style="list-style-type: none"> Ambient temperature : $-5\sim 40^{\circ}\text{C}$ Humidity : Below 70% RH ▪ The ambient temperature must be kept below 30°C. Even under ideal storage conditions, solderability of products electrodes may decrease as time passes. <p style="margin-left: 20px;">For this reason, product should be used within 6 months from the time of delivery. In case of storage over 6 months, solderability shall be checked before actual usage.</p>
Technical considerations	<ul style="list-style-type: none"> ◆ Storage <ol style="list-style-type: none"> 1. Under a high temperature and humidity environment, problems such as reduced solderability caused by oxidation of terminal electrodes and deterioration of taping/packaging materials may take place.

金属磁芯绕线型片状功率电感器 (MCOIL™ MA 系列)



回流焊

■ 型号标示法

※使用温度范围: -40~+105°C (包含产品本身发热)

M	A	K	K	2	0	1	6	T	1	R	0	M	△	△
①	②	③	④	⑤	⑥	⑦	⑧							

△=空格

① 类型

代码	类型
MA	金属磁芯绕线型片状功率电感器

② 尺寸 (T)

代码	尺寸 (T) [mm]
KK	1.0
MK	1.2

③ 尺寸 (L×W)

代码	尺寸 (L×W) [mm]
2016	2.0×1.6
2520	2.5×2.0

④ 包装

代码	包装
T	卷盘带装

⑤ 标称电感值

代码 (例)	标称电感值 [μH]
R47	0.47
1R0	1.0
4R7	4.7

※R=小数点

⑥ 电感量公差

代码	电感量公差
M	±20%

⑦ 个别规格

代码	个别规格
△	标准品

⑧ 本公司管理记号

■ 标准外型尺寸 / 标准数量

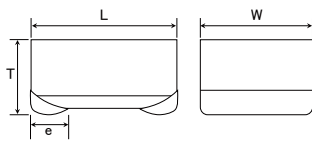

推荐焊盘图案

实装上的注意

- 请确认实装状态后使用。
- 本产品焊法限定为回流焊法。

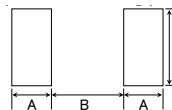

Type	A	B	C
2016	0.7	0.8	1.8
2520	0.8	1.2	2.0

单位: mm

Type	L	W	T	e	标准数量 [pcs] 卷盘带装
MAKK2016	2.0±0.1 (0.079±0.004)	1.6±0.1 (0.063±0.004)	1.0 max (0.039 max)	0.5±0.3 (0.020±0.012)	3000
MAKK2520	2.5±0.2 (0.098±0.008)	2.0±0.2 (0.079±0.008)	1.0 max (0.039 max)	0.5±0.3 (0.020±0.012)	3000
MAMK2520	2.5±0.2 (0.098±0.008)	2.0±0.2 (0.079±0.008)	1.2 max (0.047 max)	0.5±0.3 (0.020±0.012)	3000

单位: mm (inch)

▶由于篇幅有限,本产品目录中只记载了有代表性的产品规格,若考虑使用弊公司产品时,请确认交货规格说明书中的详细规格。另外,有关各产品的详细信息(特性图、可靠性信息、使用时的注意事项等),请参阅弊司网站(<http://www.ty-top.com/>)。

● MAKK2016 型 【厚度:1.0mm max.】

型号	EHS	标称电感值 [μH]	电感量公差	自共振频率 [MHz] (min.)	直流电阻 [Ω] (max.)	额定电流 ※) [mA] (max.)		测试频率 [MHz]
						直流重叠允许电流 Idc1	温度上升允许电流 Idc2	
MAKK2016TR24M	RoHS	0.24	±20%	-	0.037	4,200	3,000	2
MAKK2016TR33M	RoHS	0.33	±20%	-	0.040	3,600	3,200	2
MAKK2016TR47M	RoHS	0.47	±20%	-	0.460	3,200	2,800	2
MAKK2016TR68M	RoHS	0.68	±20%	-	0.065	2,500	2,500	2
MAKK2016T1R0M	RoHS	1.0	±20%	-	0.075	2,200	2,200	2
MAKK2016T1R5M	RoHS	1.5	±20%	-	0.130	1,600	1,650	2
MAKK2016T2R2M	RoHS	2.2	±20%	-	0.160	1,500	1,500	2
MAKK2016T3R3M	RoHS	3.3	±20%	-	0.255	1,150	1,200	2
MAKK2016T4R7M	RoHS	4.7	±20%	-	0.380	1,000	950	2

● MAKK2520 型 【厚度:1.0mm max.】

型号	EHS	标称电感值 [μH]	电感量公差	自共振频率 [MHz] (min.)	直流电阻 [Ω] (max.)	额定电流 ※) [mA] (max.)		测试频率 [MHz]
						直流重叠允许电流 Idc1	温度上升允许电流 Idc2	
MAKK2520TR33M	RoHS	0.33	±20%	-	0.038	4,700	3,500	2
MAKK2520TR47M	RoHS	0.47	±20%	-	0.046	3,900	3,200	2
MAKK2520TR68M	RoHS	0.68	±20%	-	0.059	3,700	2,900	2
MAKK2520T1R0M	RoHS	1.0	±20%	-	0.072	2,700	2,500	2
MAKK2520T1R5M	RoHS	1.5	±20%	-	0.125	2,300	1,800	2
MAKK2520T2R2M	RoHS	2.2	±20%	-	0.156	1,900	1,500	2
MAKK2520T3R3M	RoHS	3.3	±20%	-	0.200	1,550	1,300	2
MAKK2520T4R7M	RoHS	4.7	±20%	-	0.300	1,300	1,100	2

● MAMK2520 型 【厚度:1.2mm max.】

型号	EHS	标称电感值 [μH]	电感量公差	自共振频率 [MHz] (min.)	直流电阻 [Ω] (max.)	额定电流 ※) [mA] (max.)		测试频率 [MHz]
						直流重叠允许电流 Idc1	温度上升允许电流 Idc2	
MAMK2520TR47M	RoHS	0.47	±20%	-	0.039	4,200	3,400	2
MAMK2520TR68M	RoHS	0.68	±20%	-	0.048	3,200	3,200	2
MAMK2520T1R0M	RoHS	1.0	±20%	-	0.059	3,100	2,700	2
MAMK2520T2R2M	RoHS	2.2	±20%	-	0.110	2,000	1,900	2
MAMK2520T3R3M	RoHS	3.3	±20%	-	0.156	1,800	1,700	2
MAMK2520T4R7M	RoHS	4.7	±20%	-	0.260	1,500	1,300	2

※) 直流重叠允许电流 (Idc1) 为直流重叠带来的电感值下降, 范围在30%以内的直流电感值 (at 20°C)
 ※) 温度上升允许电流 (Idc2) 为温度上升到40°C时的直流电感值 (at 20°C)
 ※) 额定电流值为Idc1 或 Idc2 中较低的直流电流值。

金属磁芯绕线型片状功率电感器 (MCOIL™ MA-H 系列)



回流焊

■ 型号标示法

※使用温度范围: -40~+125°C (包含产品本身发热)

※使用温度范围: -40~+105°C (包含产品本身发热) ※1参照物料清单

M	A	K	K	2	0	1	6	H	1	R	0	M	△	△
①	②	③	④	⑤	⑥	⑦	⑧							

△=空格

① 类型

代码	类型
MA	金属磁芯绕线型片状功率电感器

② 尺寸 (T)

代码	尺寸 (T) [mm]
KK	1.0
MK	1.2

③ 尺寸 (L×W)

代码	尺寸 (L×W) [mm]
2016	2.0×1.6
2520	2.5×2.0

④ 包装

代码	包装及特殊规格
H	盘带 (高特性规格)

⑤ 标称电感值

代码 (例)	标称电感值 [μH]
R47	0.47
1R0	1.0
4R7	4.7

※R=小数点

⑥ 电感量公差

代码	电感量公差
M	±20%

⑦ 个别规格

代码	个别规格
△	标准品

⑧ 本公司管理记号

■ 标准外型尺寸 / 标准数量

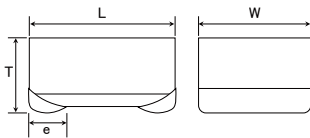

推荐焊盘图案

实装上的注意

·请确认实装状态后使用。

·本产品焊法限定为回流焊法。

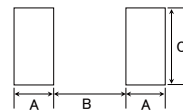

Type	A	B	C
2016	0.7	0.8	1.8
2520	0.8	1.2	2.0

单位: mm

Type	L	W	T	e	标准数量 [pcs] 卷盘带装
MAKK2016H	2.0±0.1 (0.079±0.004)	1.6±0.1 (0.063±0.004)	1.0 max (0.039 max)	0.5±0.3 (0.020±0.012)	3000
MAKK2520H	2.5±0.2 (0.098±0.008)	2.0±0.2 (0.079±0.008)	1.0 max (0.039 max)	0.5±0.3 (0.020±0.012)	3000
MAMK2520H	2.5±0.2 (0.098±0.008)	2.0±0.2 (0.079±0.008)	1.2 max (0.047 max)	0.5±0.3 (0.020±0.012)	3000

单位: mm (inch)

▶ 由于篇幅有限, 本产品目录中只记载了有代表性的产品规格, 若考虑使用弊公司产品时, 请确认交货规格说明书中的详细规格。另外, 有关各产品的详细信息(特性图、可靠性信息、使用时的注意事项等), 请参阅弊司网站(<http://www.ty-top.com/>)。

● MAKK2016H 型 【厚度:1.0mm max.】

型号	EHS	标称电感值 [μH]	电感量公差	自共振频率 [MHz] (min.)	直流电阻 [Ω] (max.)	额定电流 ※) [mA] (max.)		测试频率 [MHz]
						直流重叠允许电流 Idc1	温度上升允许电流 Idc2	
MAKK2016HR22M	RoHS	0.22	±20%	-	0.026	5.800	4.000	2
MAKK2016HR24M	RoHS	0.24	±20%	-	0.026	5.800	4.000	2
MAKK2016HR33M	RoHS	0.33	±20%	-	0.030	4.700	3.500	2
MAKK2016HR47M	RoHS	0.47	±20%	-	0.036	4.300	3.300	2
MAKK2016HR68M	RoHS	0.68	±20%	-	0.050	3.200	2.700	2
MAKK2016H1R0M	RoHS	1.0	±20%	-	0.070	2.700	2.300	2
MAKK2016H1R5M	RoHS	1.5	±20%	-	0.105	2.100	1.800	2

● MAKK2520H 型 【厚度:1.0mm max.】

型号	EHS	标称电感值 [μH]	电感量公差	自共振频率 [MHz] (min.)	直流电阻 [Ω] (max.)	额定电流 ※) [mA] (max.)		测试频率 [MHz]
						直流重叠允许电流 Idc1	温度上升允许电流 Idc2	
MAKK2520HR22M	RoHS	0.22	±20%	-	0.021	7500	4900	2
MAKK2520HR33M	RoHS	0.33	±20%	-	0.026	6200	4300	2
MAKK2520HR47M	RoHS	0.47	±20%	-	0.029	5700	4000	2
MAKK2520HR68M	RoHS	0.68	±20%	-	0.043	4300	3400	2
MAKK2520H1R0M	RoHS	1.0	±20%	-	0.053	3800	3000	2
MAKK2520H1R5M	RoHS	1.5	±20%	-	0.078	3000	2400	2
MAKK2520H2R2M	RoHS	2.2	±20%	-	0.120	2500	1800	2
MAKK2520H100M ※1	RoHS	10	±20%	-	0.650	1100	750	2

● MAMK2520H 型 【厚度:1.2mm max.】

型号	EHS	标称电感值 [μH]	电感量公差	自共振频率 [MHz] (min.)	直流电阻 [Ω] (max.)	额定电流 ※) [mA] (max.)		测试频率 [MHz]
						直流重叠允许电流 Idc1	温度上升允许电流 Idc2	
MAMK2520HR22M	RoHS	0.22	±20%	-	0.021	7500	5000	2
MAMK2520HR33M	RoHS	0.33	±20%	-	0.023	6600	4400	2
MAMK2520HR47M	RoHS	0.47	±20%	-	0.026	5800	4100	2
MAMK2520HR68M	RoHS	0.68	±20%	-	0.036	5100	3500	2
MAMK2520H1R0M	RoHS	1.0	±20%	-	0.045	4300	3100	2
MAMK2520H1R5M	RoHS	1.5	±20%	-	0.065	3300	2600	2
MAMK2520H2R2M	RoHS	2.2	±20%	-	0.090	2800	2200	2

※) 直流重叠允许电流 (Idc1) 为直流重叠带来的电感值下降, 范围在30%以内的直流电感值 (at 20°C)

※) 温度上升允许电流 (Idc2) 为温度上升到40°C时的直流电感值 (at 20°C)

※) 额定电流值为Idc1 或 Idc2 中较低的直流电流值。

METAL CORE WIRE-WOUND CHIP POWER INDUCTORS (MCOIL™ MA SERIES / MCOIL™ MA-H SERIES)

PACKAGING

① Minimum Quantity

Type	Standard Quantity [pcs]
	Tape & Reel
MAKK2016	3000
MAKK2520	3000
MAMK2520	3000

② Tape Material

● Embossed Tape

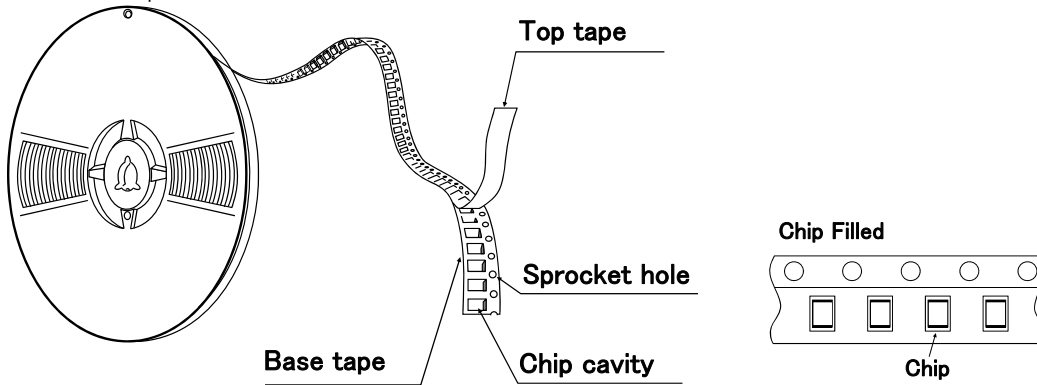

③ Taping dimensions

● Embossed tape 8mm wide (0.315 inches wide)

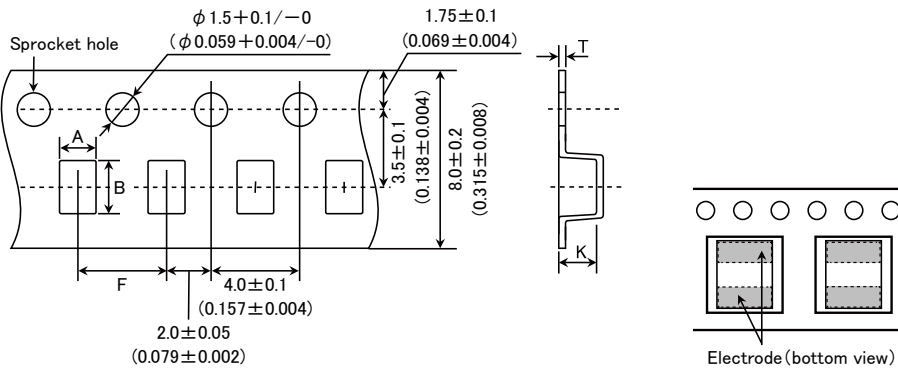

Type	Chip cavity		Insertion pitch	Tape thickness	
	A	B	F	T	K
MAKK2016	1.9 ± 0.1 (0.075 ± 0.004)	2.3 ± 0.1 (0.091 ± 0.004)	4.0 ± 0.1 (0.157 ± 0.004)	0.25 ± 0.05 (0.009 ± 0.002)	1.2 max (0.047 max)
MAKK2520	2.3 ± 0.1 (0.091 ± 0.004)	2.8 ± 0.1 (0.110 ± 0.004)	4.0 ± 0.1 (0.157 ± 0.004)	0.3 ± 0.05 (0.012 ± 0.002)	1.25 max (0.049 max)
MAMK2520	2.3 ± 0.1 (0.091 ± 0.004)	2.8 ± 0.1 (0.110 ± 0.004)	4.0 ± 0.1 (0.157 ± 0.004)	0.3 ± 0.05 (0.012 ± 0.002)	1.4 max (0.055 max)

Unit: mm (inch)

④ Leader and Blank portion

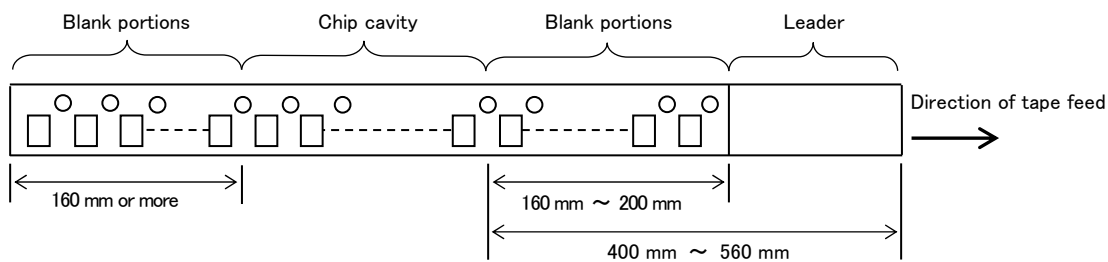

▶ This catalog contains the typical specification only due to the limitation of space. When you consider the purchase of our products, please check our specification. For details of each product (characteristics graph, reliability information, precautions for use, and so on), see our Web site (<http://www.ty-top.com/>).

⑤ Reel size

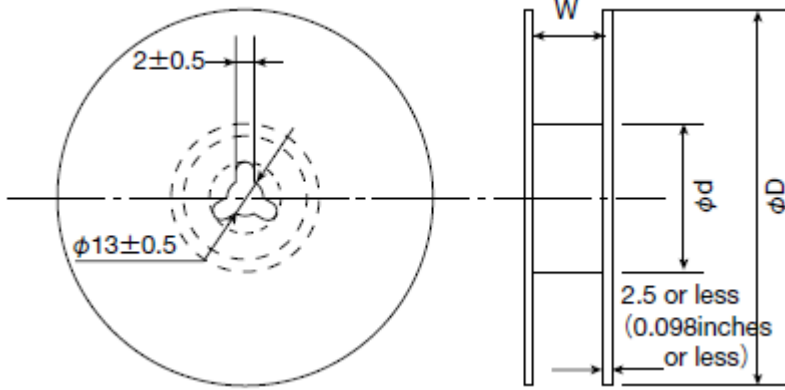

Type	Reel size (Reference values)		
	ϕD	ϕd	W
MAKK2016	180+0/-3	60+1/-0	10.0±1.5
MAKK2520	(7.087+0/-0.118)	(2.36+0.039/0)	(0.394±0.059)
MAMK2520			

Unit: mm (inch)

⑥ Top Tape Strength

The top tape requires a peel-off force of 0.1 to 1.2N in the direction of the arrow as illustrated below.

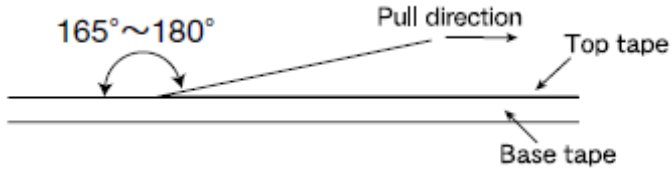

► This catalog contains the typical specification only due to the limitation of space. When you consider the purchase of our products, please check our specification. For details of each product (characteristics graph, reliability information, precautions for use, and so on), see our Web site (<http://www.ty-top.com/>).

METAL CORE WIRE-WOUND CHIP POWER INDUCTORS (MCOIL™ MA SERIES / MCOIL™ MA-H SERIES)

RELIABILITY DATA

1. Operating Temperature Range		
Specified Value	MA series	-40~+105°C
	MA-H series	-40~+125°C
Test Methods and Remarks	Including self-generated heat	
2. Storage Temperature Range		
Specified Value	MA series	-40~+85°C
	MA-H series	
Test Methods and Remarks	0 to 40°C for the product with taping.	
3. Rated current		
Specified Value	MA series	Within the specified tolerance
	MA-H series	
4. Inductance		
Specified Value	MA series	Within the specified tolerance
	MA-H series	
Test Methods and Remarks	Measuring equipment : LCR Meter (HP 4285A or equivalent) Measuring frequency : 2MHz, 1V	
5. DC Resistance		
Specified Value	MA series	Within the specified tolerance
	MA-H series	
Test Methods and Remarks	Measuring equipment : DC ohmmeter (HIOKI 3227 or equivalent)	
6. Self resonance frequency		
Specified Value	MA series	-
	MA-H series	
7. Temperature characteristic		
Specified Value	MA series	Inductance change : Within $\pm 15\%$
	MA-H series	
Test Methods and Remarks	Measurement of inductance shall be taken at temperature range within -40°C~+85°C. With reference to inductance value at +20°C., change rate shall be calculated.	
8. Resistance to flexure of substrate		
Specified Value	MA series	No damage
	MA-H series	
Test Methods and Remarks	<p>The test samples shall be soldered to the test board by the reflow. As illustrated below, apply force in the direction of the arrow indicating until deflection of the test board reaches to 2 mm.</p> <p>Test board size : 100 × 40 × 1.0 mm Test board material : Glass epoxy-resin Solder cream thickness : 0.12 mm</p>	

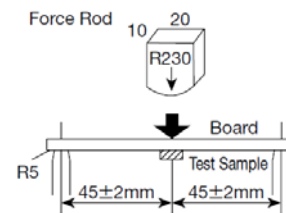

▶ This catalog contains the typical specification only due to the limitation of space. When you consider the purchase of our products, please check our specification.
 For details of each product (characteristics graph, reliability information, precautions for use, and so on), see our Web site (<http://www.ty-top.com/>).

9. Insulation resistance : between wires													
Specified Value	MA series	—											
	MA-H series												
10. Insulation resistance : between wire and core													
Specified Value	MA series	DC25V 100kΩ min											
	MA-H series												
11. Withstanding voltage : between wire and core													
Specified Value	MA series	—											
	MA-H series												
12. Adhesion of terminal electrode													
Specified Value	MA series	No abnormality.											
	MA-H series												
Test Methods and Remarks	<p>The test samples shall be soldered to the test board by the reflow.</p> <p>Applied force : 10N to X and Y directions.</p> <p>Duration : 5s.</p> <p>Solder cream thickness : 0.12mm.</p>												
13. Resistance to vibration													
Specified Value	MA series	Inductance change : Within $\pm 10\%$ No significant abnormality in appearance.											
	MA-H series												
Test Methods and Remarks	<p>The test samples shall be soldered to the test board by the reflow.</p> <p>Then it shall be submitted to below test conditions.</p> <table border="1"> <tr> <td>Frequency Range</td> <td>10~55Hz</td> </tr> <tr> <td>Total Amplitude</td> <td>1.5mm (May not exceed acceleration 196m/s²)</td> </tr> <tr> <td>Sweeping Method</td> <td>10Hz to 55Hz to 10Hz for 1min.</td> </tr> <tr> <td rowspan="3">Time</td> <td>X</td> <td rowspan="3">For 2 hours on each X, Y, and Z axis.</td> </tr> <tr> <td>Y</td> </tr> <tr> <td>Z</td> </tr> </table> <p>Recovery : At least 2hrs of recovery under the standard condition after the test, followed by the measurement within 48hrs.</p>		Frequency Range	10~55Hz	Total Amplitude	1.5mm (May not exceed acceleration 196m/s ²)	Sweeping Method	10Hz to 55Hz to 10Hz for 1min.	Time	X	For 2 hours on each X, Y, and Z axis.	Y	Z
	Frequency Range	10~55Hz											
Total Amplitude	1.5mm (May not exceed acceleration 196m/s ²)												
Sweeping Method	10Hz to 55Hz to 10Hz for 1min.												
Time	X	For 2 hours on each X, Y, and Z axis.											
	Y												
	Z												
14. Solderability													
Specified Value	MA series	At least 90% of surface of terminal electrode is covered by new solder.											
	MA-H series												
Test Methods and Remarks	<p>The test samples shall be dipped in flux, and then immersed in molten solder as shown in below table.</p> <p>Flux : Methanol solution containing rosin 25%.</p> <table border="1"> <tr> <td>Solder Temperature</td> <td>245\pm5°C</td> </tr> <tr> <td>Time</td> <td>5\pm0.5 sec.</td> </tr> </table> <p>※Immersion depth : All sides of mounting terminal shall be immersed.</p>		Solder Temperature	245 \pm 5°C	Time	5 \pm 0.5 sec.							
Solder Temperature	245 \pm 5°C												
Time	5 \pm 0.5 sec.												
15. Resistance to soldering heat													
Specified Value	MA series	Inductance change : Within $\pm 10\%$ No significant abnormality in appearance.											
	MA-H series												
Test Methods and Remarks	<p>The test sample shall be exposed to reflow oven at 230°C for 40 seconds, with peak temperature at 260+0/-5°C for 5 seconds, 3 times.</p> <p>Test board material : Glass epoxy-resin</p> <p>Test board thickness : 1.0mm</p> <p>Recovery : At least 2hrs of recovery under the standard condition after the test, followed by the measurement within 48hrs.</p>												

16. Thermal shock		
Specified Value	MA series	Inductance change : Within $\pm 10\%$ No significant abnormality in appearance.
	MA-H series	
Test Methods and Remarks	The test samples shall be soldered to the test board by the reflow. The test samples shall be placed at specified temperature for specified time by step 1 to step 4 as shown in below table in sequence. The temperature cycle shall be repeated 100 cycles.	
	Conditions of 1 cycle	
	Step	Temperature ($^{\circ}\text{C}$)
	1	-40 ± 3
	2	Room temperature
	3	$+85 \pm 2$
4	Room temperature	
Recovery : At least 2hrs of recovery under the standard condition after the test, followed by the measurement within 48hrs.		Duration (min)
		30 ± 3
		Within 3
		30 ± 3
		Within 3

17. Damp heat		
Specified Value	MA series	Inductance change : Within $\pm 10\%$ No significant abnormality in appearance.
	MA-H series	
Test Methods and Remarks	The test samples shall be soldered to the test board by the reflow.	
	The test samples shall be placed in thermostatic oven set at specified temperature and humidity as shown in below table.	
	Temperature	$60 \pm 2^{\circ}\text{C}$
	Humidity	$90 \sim 95\% \text{RH}$
	Time	$500 + 24 / - 0$ hour
Recovery : At least 2hrs of recovery under the standard condition after the test, followed by the measurement within 48hrs.		

18. Loading under damp heat		
Specified Value	MA series	Inductance change : Within $\pm 10\%$ No significant abnormality in appearance.
	MA-H series	
Test Methods and Remarks	The test samples shall be soldered to the test board by the reflow.	
	The test samples shall be placed in thermostatic oven set at specified temperature and humidity and applied the rated current continuously as shown in below table.	
	Temperature	$60 \pm 2^{\circ}\text{C}$
	Humidity	$90 \sim 95\% \text{RH}$
	Applied current	Rated current
	Time	$500 + 24 / - 0$ hour
Recovery : At least 2hrs of recovery under the standard condition after the test, followed by the measurement within 48hrs.		

19. Low temperature life test		
Specified Value	MA series	Inductance change : Within $\pm 10\%$ No significant abnormality in appearance.
	MA-H series	
Test Methods and Remarks	The test samples shall be soldered to the test board by the reflow. After that, the test samples shall be placed at test conditions as shown in below table.	
	Temperature	$-40 \pm 2^{\circ}\text{C}$
	Time	$500 + 24 / - 0$ hour
	Recovery : At least 2hrs of recovery under the standard condition after the test, followed by the measurement within 48hrs.	

20. High temperature life test		
Specified Value	MA series	Inductance change : Within $\pm 10\%$ No significant abnormality in appearance.
	MA-H series	
Test Methods and Remarks	The test samples shall be soldered to the test board by the reflow. After that, the test samples shall be placed at test conditions as shown in below table.	
	Temperature	$85 \pm 2^{\circ}\text{C}$
	Time	$500 + 24 / - 0$ hour
	Recovery : At least 2hrs of recovery under the standard condition after the test, followed by the measurement within 48hrs.	

21. Loading at high temperature life test		
Specified Value	MA series	-
	MA-H series	

22. Standard condition

Specified Value	MA series	Standard test condition : Unless otherwise specified, temperature is $20 \pm 15^{\circ}\text{C}$ and $65 \pm 20\%$ of relative humidity. When there is any question concerning measurement result: In order to provide correlation data, the test shall be condition of $20 \pm 2^{\circ}\text{C}$ of temperature, $65 \pm 5\%$ relative humidity. Inductance is in accordance with our measured value.
	MA-H series	

METAL CORE WIRE-WOUND CHIP POWER INDUCTORS (MCOIL™ MA SERIES / MCOIL™ MA-H SERIES)

■ PRECAUTIONS

1. Circuit Design	
Precautions	<p>◆Operating environment</p> <p>1. The products described in this specification are intended for use in general electronic equipment,(office supply equipment, telecommunications systems, measuring equipment, and household equipment). They are not intended for use in mission-critical equipment or systems requiring special quality and high reliability (traffic systems, safety equipment, aerospace systems, nuclear control systems and medical equipment including life-support systems.) where product failure might result in loss of life, injury or damage. For such uses, contact TAIYO YUDEN Sales Department in advance.</p>
2. PCB Design	
Precautions	<p>◆Land pattern design</p> <p>1. Please refer to a recommended land pattern.</p>
Technical considerations	<p>◆Land pattern design</p> <p>Surface Mounting</p> <ul style="list-style-type: none"> • Mounting and soldering conditions should be checked beforehand. • Applicable soldering process to this products is reflow soldering only.
3. Considerations for automatic placement	
Precautions	<p>◆Adjustment of mounting machine</p> <p>1. Excessive impact load should not be imposed on the products when mounting onto the PC boards.</p> <p>2. Mounting and soldering conditions should be checked beforehand.</p>
Technical considerations	<p>◆Adjustment of mounting machine</p> <p>1. When installing products, care should be taken not to apply distortion stress as it may deform the products.</p>
4. Soldering	
Precautions	<p>◆Reflow soldering</p> <p>1. Please contact any of our offices for a reflow soldering, and refer to the recommended condition specified.</p> <p>2. The product shall be used reflow soldering only.</p> <p>3. Please do not add any stress to a product until it returns in normal temperature after reflow soldering.</p> <p>◆Lead free soldering</p> <p>1. When using products with lead free soldering, we request to use them after confirming adhesion, temperature of resistance to soldering heat, soldering etc sufficiently.</p>
Technical considerations	<p>◆Reflow soldering</p> <p>1. If products are used beyond the range of the recommended conditions, heat stresses may deform the products, and consequently degrade the reliability of the products.</p> <p>Recommended reflow condition (Pb free solder)</p> <p>Temperature [°C]</p> <p>Heating Time [sec]</p> <p>150~180</p> <p>90±30sec</p> <p>230°C min</p> <p>40sec max</p> <p>5sec max</p> <p>Peak: 260+0/-5°C</p>
5. Cleaning	
Precautions	<p>◆Cleaning conditions</p> <p>1. Washing by supersonic waves shall be avoided.</p>
Technical considerations	<p>◆Cleaning conditions</p> <p>1. If washed by supersonic waves, the products might be broken.</p>

▶ This catalog contains the typical specification only due to the limitation of space. When you consider the purchase of our products, please check our specification. For details of each product (characteristics graph, reliability information, precautions for use, and so on), see our Web site (<http://www.ty-top.com/>).

6. Handling	
Precautions	<ul style="list-style-type: none"> ◆ Handling <ol style="list-style-type: none"> 1. Keep the product away from all magnets and magnetic objects. ◆ Breakaway PC boards (splitting along perforations) <ol style="list-style-type: none"> 1. When splitting the PC board after mounting product, care should be taken not to give any stresses of deflection or twisting to the board. 2. Board separation should not be done manually, but by using the appropriate devices. ◆ Mechanical considerations <ol style="list-style-type: none"> 1. Please do not give the product any excessive mechanical shocks. 2. Please do not add any shock and power to a product in transportation. ◆ Pick-up pressure <ol style="list-style-type: none"> 1. Please do not push to add any pressure to a winding part. Please do not give any shock and push into a ferrite core exposure part. ◆ Packing <ol style="list-style-type: none"> 1. Please avoid accumulation of a packing box as much as possible.
Technical considerations	<ul style="list-style-type: none"> ◆ Handling <ol style="list-style-type: none"> 1. There is a case that a characteristic varies with magnetic influence. ◆ Breakaway PC boards (splitting along perforations) <ol style="list-style-type: none"> 1. The position of the product on PCBs shall be carefully considered to minimize the stress caused from splitting of the PCBs. ◆ Mechanical considerations <ol style="list-style-type: none"> 1. There is a case to be damaged by a mechanical shock. 2. There is a case to be broken by the handling in transportation. ◆ Pick-up pressure <ol style="list-style-type: none"> 1. Damage and a characteristic can vary with an excessive shock or stress. ◆ Packing <ol style="list-style-type: none"> 1. If packing boxes are accumulated, that could cause a deformation on packing tapes or a damage on the products.
7. Storage conditions	
Precautions	<ul style="list-style-type: none"> ◆ Storage <ol style="list-style-type: none"> 1. To maintain the solderability of terminal electrodes and to keep the packing material in good condition, temperature and humidity in the storage area should be controlled. <ul style="list-style-type: none"> ▪ Recommended conditions <ul style="list-style-type: none"> Ambient temperature : 0~40°C Humidity : Below 70% RH ▪ The ambient temperature must be kept below 30°C. Even under ideal storage conditions, solderability of products electrodes may decrease as time passes. <ul style="list-style-type: none"> For this reason, product should be used within 6 months from the time of delivery. In case of storage over 6 months, solderability shall be checked before actual usage.
Technical considerations	<ul style="list-style-type: none"> ◆ Storage <ol style="list-style-type: none"> 1. Under a high temperature and humidity environment, problems such as reduced solderability caused by oxidation of terminal electrodes and deterioration of taping/packaging materials may take place.

金属绕线型片状功率电感器 (MCOIL™ MB 系列)



回流焊

■ 型号标示法

※使用温度范围: -40~+105°C (包含产品本身发热)

M	B	K	K	1	6	0	8	T	1	R	0	M	△
①	②	③	④	⑤	⑥	⑦							

△=空格

① 类型

代码	类型
MB	金属绕线型片状功率电感器

② 尺寸 (T)

代码	尺寸 (T) [mm]
KK	1.0
MK	1.2

③ 尺寸 (L×W)

代码	外型 (inch)	尺寸 (L×W) [mm]
1608	1608 (0603)	1.6 × 0.8
2012	2012 (0805)	2.0 × 1.25
2520	2520 (1008)	2.5 × 2.0

④ 包装

代码	包装
T	卷盘带装

⑤ 标称电感值

代码 (例)	标称电感值 [μH]
R24	0.24
1R0	1.0
4R7	4.7

※R=小数点

⑥ 电感量公差

代码	电感量公差
M	±20%
N	±30%

⑦ 本公司管理记号

■ 标准外型尺寸 / 标准数量

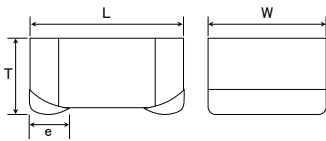

推荐焊盘图案

实装上的注意

- 请确认实装状态后使用。
- 本产品焊法限定为回流焊法。

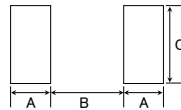

型号	A	B	C
1608	0.55	0.70	1.00
2012	0.60	1.00	1.45
2520	0.60	1.50	2.00

单位: mm (inch)

型号	L	W	T	e	标准数量 [pcs]	
					纸带	压纹带
MBKK1608	1.6±0.2 (0.063±0.008)	0.8±0.2 (0.031±0.008)	1.0 max (0.040 max)	0.45±0.15 (0.016±0.006)	—	3000
MBKK2012	2.0±0.2 (0.079±0.008)	1.25±0.2 (0.049±0.008)	1.0 max (0.040 max)	0.5±0.2 (0.020±0.008)	—	3000
MBMK2520	2.5±0.2 (0.098±0.008)	2.0±0.2 (0.079±0.008)	1.2 max (0.047 max)	0.5±0.2 (0.020±0.008)	—	3000

单位: mm (inch)

▶ 由于篇幅有限, 本产品目录中只记载了有代表性的产品规格, 若考虑使用弊公司产品时, 请确认交货规格说明书中的详细规格。另外, 有关各产品的详细信息(特性图、可靠性信息、使用时的注意事项等), 请参阅弊网站(<http://www.ty-top.com/>)。

● MBKK1608 (0603) 型 【厚度:1.0mm max.】

型号	EHS	标称电感值 [μH]	电感量公差	自共振频率 [MHz] (min.)	直流电阻 [Ω] (max.)	额定电流 ※) [mA] (max.)		测试频率 [MHz]
						直流重叠允许电流 Idc1	温度上升允许电流 Idc2	
MBKK1608TR24N	RoHS	0.24	±30%	-	0.049	1,650	2,300	1.0
MBKK1608TR47N	RoHS	0.47	±30%	-	0.104	1,100	1,400	1.0
MBKK1608TR68N	RoHS	0.68	±30%	-	0.120	950	1,200	1.0
MBKK1608T1R0M	RoHS	1.0	±20%	-	0.150	800	1,150	1.0
MBKK1608T1R5M	RoHS	1.5	±20%	-	0.200	650	1,000	1.0
MBKK1608T2R2M	RoHS	2.2	±20%	-	0.345	520	750	1.0
MBKK1608T3R3M	RoHS	3.3	±20%	-	0.512	450	600	1.0
MBKK1608T4R7M	RoHS	4.7	±20%	-	0.730	370	500	1.0

● MBKK2012 (0805) 型 【厚度:1.0mm max.】

型号	EHS	标称电感值 [μH]	电感量公差	自共振频率 [MHz] (min.)	直流电阻 [Ω] (max.)	额定电流 ※) [mA] (max.)		测试频率 [MHz]
						直流重叠允许电流 Idc1	温度上升允许电流 Idc2	
MBKK2012TR24N	RoHS	0.24	±30%	-	0.041	3,000	2,400	1.0
MBKK2012TR47N	RoHS	0.47	±30%	-	0.078	2,000	1,650	1.0
MBKK2012TR68N	RoHS	0.68	±30%	-	0.090	1,800	1,500	1.0
MBKK2012T1R0M	RoHS	1.0	±20%	-	0.106	1,500	1,450	1.0
MBKK2012T1R5M	RoHS	1.5	±20%	-	0.173	1,200	1,100	1.0
MBKK2012T2R2M	RoHS	2.2	±20%	-	0.290	900	850	1.0
MBKK2012T3R3M	RoHS	3.3	±20%	-	0.500	700	650	1.0
MBKK2012T4R7M	RoHS	4.7	±20%	-	0.615	600	600	1.0

● MBMK2520 (1008) 型 【厚度:1.2mm max.】

型号	EHS	标称电感值 [μH]	电感量公差	自共振频率 [MHz] (min.)	直流电阻 [Ω] (max.)	额定电流 ※) [mA] (max.)		测试频率 [MHz]
						直流重叠允许电流 Idc1	温度上升允许电流 Idc2	
MBMK2520TR24N	RoHS	0.24	±30%	-	0.026	4,750	3,500	1.0
MBMK2520TR47N	RoHS	0.47	±30%	-	0.042	3,900	2,600	1.0
MBMK2520TR68N	RoHS	0.68	±30%	-	0.058	3,150	2,150	1.0
MBMK2520T1R0M	RoHS	1.0	±20%	-	0.072	2,350	1,850	1.0
MBMK2520T1R5M	RoHS	1.5	±20%	-	0.106	2,050	1,500	1.0
MBMK2520T2R2M	RoHS	2.2	±20%	-	0.159	1,800	1,250	1.0
MBMK2520T3R3M	RoHS	3.3	±20%	-	0.260	1,400	970	1.0
MBMK2520T4R7M	RoHS	4.7	±20%	-	0.380	1,150	800	1.0

※) 直流重叠允许电流 (Idc1) 为直流重叠带来的电感值下降, 范围在30%以内的直流电感值 (at 20°C)

※) 温度上升允许电流 (Idc2) 为温度上升到40°C时的直流电感值 (at 20°C)

※) 额定电流值: Idc1或Idc2中低的一方的直流电流值当作额定电流值。

金属绕线型片状功率电感器 (MCOIL™ MB-H 系列)



回流焊

■ 型号标示法

※使用温度范围: -40~+105°C (包含产品本身发热)

M	B	K	K	1	6	0	8	H	1	R	0	M	△
①	②	③	④	⑤	⑥	⑦							

△=空格

① 类型

代码	类型
MB	金属绕线型片状功率电感器

② 尺寸 (T)

代码	尺寸 (T) [mm]
KK	1.0
MK	1.2

③ 尺寸 (L×W)

代码	外型 (inch)	尺寸 (L×W) [mm]
1608	1608 (0603)	1.6 × 0.8
2520	2520 (1008)	2.5 × 2.0

④ 包装

代码	包装
H	胶带 (高特性规格)

⑤ 标称电感值

代码 (例)	标称电感值 [μH]
R24	0.24
1R0	1.0
4R7	4.7

※R=小数点

⑥ 电感量公差

代码	电感量公差
M	±20%
N	±30%

⑦ 本公司管理记号

■ 标准外型尺寸 / 标准数量

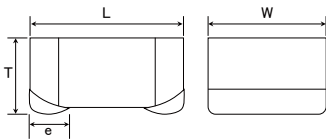

推荐焊盘图案

实装上的注意

- 请确认实装状态后使用。
- 本产品焊法限定为回流焊法。

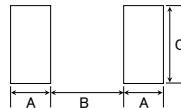

型号	A	B	C
1608	0.55	0.70	1.00
2520	0.60	1.50	2.00

单位: mm (inch)

型号	L	W	T	e	标准数量 [pcs]	
					纸带	压纹带
MBKK1608	1.6±0.2 (0.063±0.008)	0.8±0.2 (0.031±0.008)	1.0 max (0.040 max)	0.45±0.15 (0.016±0.006)	—	3000
MBMK2520	2.5±0.2 (0.098±0.008)	2.0±0.2 (0.079±0.008)	1.2 max (0.047 max)	0.5±0.2 (0.020±0.008)	—	3000

单位: mm (inch)

▶ 由于篇幅有限, 本产品目录中只记载了有代表性的产品规格, 若考虑使用弊公司产品时, 请确认交货规格说明书中的详细规格。另外, 有关各产品的详细信息(特性图、可靠性信息、使用时的注意事项等), 请参阅弊司网站(<http://www.ty-top.com/>)。

● MBKK1608H (0603) 型 【厚度:1.0mm max.】

型号	EHS	标称电感值 [μH]	电感量公差	自共振频率 [MHz] (min.)	直流电阻 [Ω] (max.)	额定电流 ※) [mA] (max.)		测试频率 [MHz]
						直流重叠允许电流 Idc1	温度上升允许电流 Idc2	
MBKK1608HR24N	RoHS	0.24	±30%	-	0.049	1,650	2,300	1.0
MBKK1608HR47N	RoHS	0.47	±30%	-	0.104	1,100	1,400	1.0
MBKK1608HR68N	RoHS	0.68	±30%	-	0.120	950	1,200	1.0
MBKK1608H1R0M	RoHS	1.0	±20%	-	0.150	800	1,150	1.0
MBKK1608H1R5M	RoHS	1.5	±20%	-	0.200	650	1,000	1.0
MBKK1608H2R2M	RoHS	2.2	±20%	-	0.345	520	750	1.0
MBKK1608H3R3M	RoHS	3.3	±20%	-	0.512	450	600	1.0
MBKK1608H4R7M	RoHS	4.7	±20%	-	0.730	370	500	1.0

● MBMK2520H (1008) 型 【厚度:1.2mm max.】

型号	EHS	标称电感值 [μH]	电感量公差	自共振频率 [MHz] (min.)	直流电阻 [Ω] (max.)	额定电流 ※) [mA] (max.)		测试频率 [MHz]
						直流重叠允许电流 Idc1	温度上升允许电流 Idc2	
MBMK2520HR24N	RoHS	0.24	±30%	-	0.026	4,750	3,500	1.0
MBMK2520HR47N	RoHS	0.47	±30%	-	0.042	3,900	2,600	1.0
MBMK2520HR68N	RoHS	0.68	±30%	-	0.058	3,150	2,150	1.0
MBMK2520H1R0M	RoHS	1.0	±20%	-	0.072	2,350	1,850	1.0
MBMK2520H1R5M	RoHS	1.5	±20%	-	0.106	2,050	1,500	1.0
MBMK2520H2R2M	RoHS	2.2	±20%	-	0.159	1,800	1,250	1.0
MBMK2520H3R3M	RoHS	3.3	±20%	-	0.260	1,400	970	1.0
MBMK2520H4R7M	RoHS	4.7	±20%	-	0.380	1,150	800	1.0

※) 直流重叠允许电流 (Idc1) 为直流重叠带来的电感值下降, 范围在30%以内的直流电感值 (at 20°C)

※) 温度上升允许电流 (Idc2) 为温度上升到40°C时的直流电感值 (at 20°C)

※) 额定电流值: Idc1或Idc2中低的一方的直流电流值当作额定电流值。

METAL WIRE-WOUND CHIP POWER INDUCTORS (MCOIL™ MB SERIES/MCOIL™ MB-H SERIES)

PACKAGING

① Minimum Quantity

Type	Standard Quantity [pcs]
	Tape & Reel
MBKK1608/MBKK1608H	3000
MBKK2012	3000
MBMK2520/MBMK2520H	3000

② Tape Material

● Embossed Tape

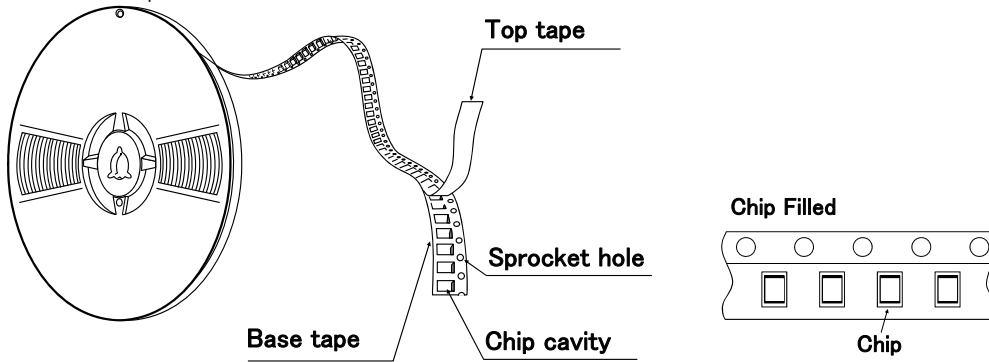

③ Taping dimensions

● Embossed tape 8mm wide (0.315 inches wide)

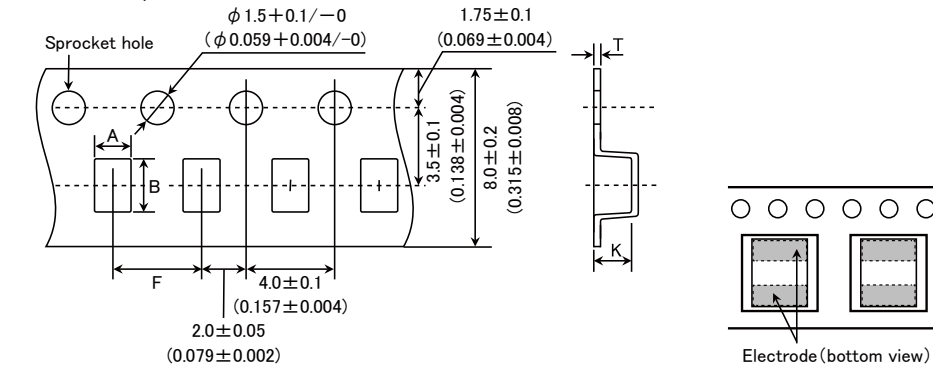

Type	Chip cavity		Insertion pitch	Tape thickness	
	A	B	F	T	K
MBKK1608/MBKK1608H	1.1 (0.043)	1.9 (0.075)	4.0 ± 0.1 (0.157 ± 0.004)	0.25 ± 0.05 (0.010 ± 0.002)	1.2 max (0.047 max)
MBKK2012	1.45 (0.057)	2.2 (0.087)	4.0 ± 0.1 (0.157 ± 0.004)	0.25 ± 0.05 (0.010 ± 0.002)	1.2 max (0.047 max)
MBMK2520/MBMK2520H	2.3 (0.091)	2.8 (0.110)	4.0 ± 0.1 (0.157 ± 0.004)	0.3 ± 0.05 (0.012 ± 0.002)	1.45 max (0.057 max)

Unit : mm (inch)

④ Leader and Blank portion

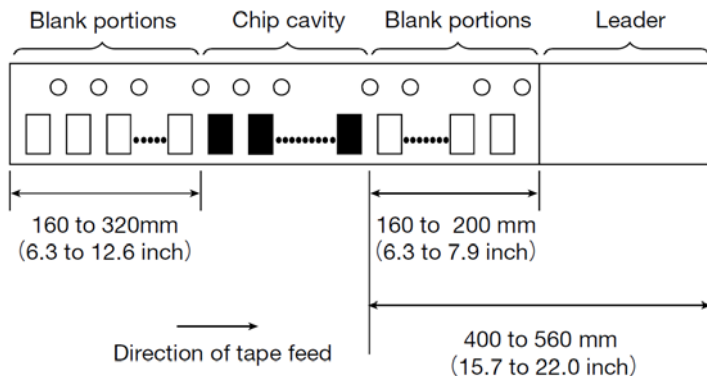

▶ This catalog contains the typical specification only due to the limitation of space. When you consider the purchase of our products, please check our specification. For details of each product (characteristics graph, reliability information, precautions for use, and so on), see our Web site (<http://www.ty-top.com/>).

⑤ Reel size

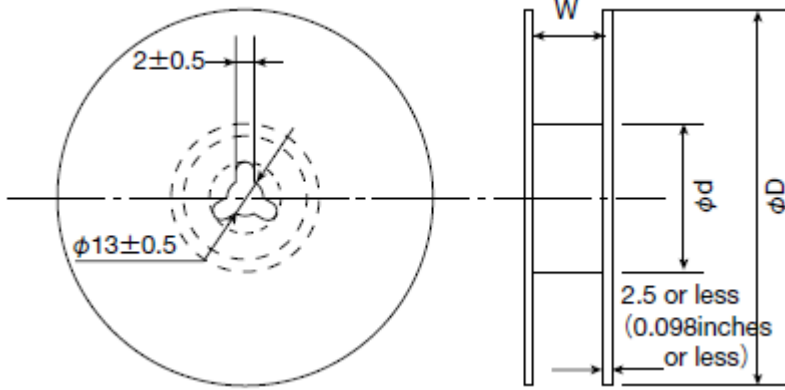

Type	Reel size (Reference values)		
	ϕD	ϕd	W
MBKK1608 / MBKK1608H	180+0/-3 (7.087+0/-0.118)	60+1/-0 (2.36+0.039/0)	10.0±1.5 (0.394±0.059)
MBKK2012			
MBMK2520 / MBMK2520H			

Unit: mm (inch)

⑥ Top Tape Strength

The top tape requires a peel-off force of 0.2 to 0.7N in the direction of the arrow as illustrated below.

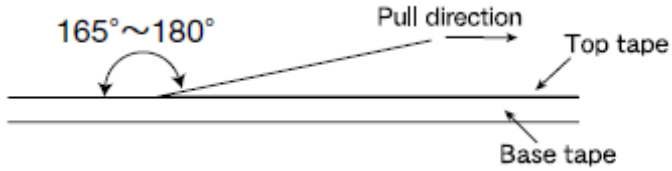

METAL WIRE-WOUND CHIP POWER INDUCTORS

(MCOIL™ MB SERIES/MCOIL™ MB-H SERIES)

RELIABILITY DATA

1. Operating Temperature Range		
Specified Value	MB series	-40~+105°C
	MB-H series	-40~+125°C
Test Methods and Remarks	Including self-generated heat	
2. Storage Temperature Range		
Specified Value	MB series	-40~+85°C
	MB-H series	
Test Methods and Remarks	0 to 40°C for the product with taping.	
3. Rated current		
Specified Value	MB series	Within the specified tolerance
	MB-H series	
4. Inductance		
Specified Value	MB series	Within the specified tolerance
	MB-H series	
Test Methods and Remarks	Measuring equipment : LCR Meter (HP 4285A or equivalent) Measuring frequency : 1MHz, 1V	
5. DC Resistance		
Specified Value	MB series	Within the specified tolerance
	MB-H series	
Test Methods and Remarks	Measuring equipment : DC ohmmeter (HIOKI 3227 or equivalent)	
6. Self resonance frequency		
Specified Value	MB series	-
	MB-H series	
7. Temperature characteristic		
Specified Value	MB series	Inductance change : Within $\pm 15\%$
	MB-H series	
Test Methods and Remarks	MB series : Measurement of inductance shall be taken at temperature range within -40°C~+105°C. With reference to inductance value at +20°C., change rate shall be calculated.	
	MB-H series : Measurement of inductance shall be taken at temperature range within -40°C~+125°C. With reference to inductance value at +20°C., change rate shall be calculated.	

▶ This catalog contains the typical specification only due to the limitation of space. When you consider the purchase of our products, please check our specification.
 For details of each product (characteristics graph, reliability information, precautions for use, and so on), see our Web site (<http://www.ty-top.com/>).

8. Resistance to flexure of substrate		
Specified Value	MB series	No damage
	MB-H series	
Test Methods and Remarks	<p>The test samples shall be soldered to the test board by the reflow. As illustrated below, apply force in the direction of the arrow indicating until deflection of the test board reaches to 2 mm.</p> <p>Test board size : 100 × 40 × 1.0 mm (1608:0.8mm) Test board material : Glass epoxy-resin Solder cream thickness : 0.1 mm</p>	

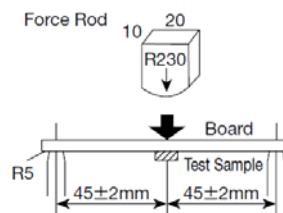

9. Insulation resistance : between wires		
Specified Value	MB series	—
	MB-H series	

10. Insulation resistance : between wire and core		
Specified Value	MB series	DC25V 100kΩ min
	MB-H series	DC50V 100kΩ min

11. Withstanding voltage : between wire and core		
Specified Value	MB series	—
	MB-H series	

12. Adhesion of terminal electrode		
Specified Value	MB series	No abnormality.
	MB-H series	
Test Methods and Remarks	<p>The test samples shall be soldered to the test board by the reflow.</p> <p>Applied force : 10N (1608:5N) to X and Y directions. Duration : 5s. Solder cream thickness : 0.1mm.</p>	

13. Resistance to vibration																
Specified Value	MB series	Inductance change : Within ± 10%														
	MB-H series	No significant abnormality in appearance.														
Test Methods and Remarks	<p>The test samples shall be soldered to the test board by the reflow. Then it shall be submitted to below test conditions.</p> <table border="1"> <tr> <td>Frequency Range</td> <td colspan="2">10~55Hz</td> </tr> <tr> <td>Total Amplitude</td> <td colspan="2">1.5mm (May not exceed acceleration 196m/s²)</td> </tr> <tr> <td>Sweeping Method</td> <td colspan="2">10Hz to 55Hz to 10Hz for 1min.</td> </tr> <tr> <td rowspan="3">Time</td> <td>X</td> <td rowspan="3">For 2 hours on each X, Y, and Z axis.</td> </tr> <tr> <td>Y</td> </tr> <tr> <td>Z</td> </tr> </table> <p>Recovery : At least 2hrs of recovery under the standard condition after the test, followed by the measurement within 48hrs.</p>		Frequency Range	10~55Hz		Total Amplitude	1.5mm (May not exceed acceleration 196m/s ²)		Sweeping Method	10Hz to 55Hz to 10Hz for 1min.		Time	X	For 2 hours on each X, Y, and Z axis.	Y	Z
Frequency Range	10~55Hz															
Total Amplitude	1.5mm (May not exceed acceleration 196m/s ²)															
Sweeping Method	10Hz to 55Hz to 10Hz for 1min.															
Time	X	For 2 hours on each X, Y, and Z axis.														
	Y															
	Z															

14. Solderability								
Specified Value	MB series	At least 90% of surface of terminal electrode is covered by new solder.						
	MB-H series							
Test Methods and Remarks	<p>The test samples shall be dipped in flux, and then immersed in molten solder as shown in below table.</p> <p>Flux : Methanol solution containing rosin 25%.</p> <table border="1"> <tr> <td>Solder Temperature</td> <td>245±5°C</td> </tr> <tr> <td>Immersing speed</td> <td>25mm/s</td> </tr> <tr> <td>Time</td> <td>5±0.5 sec.</td> </tr> </table> <p>※Immersion depth : All sides of mounting terminal shall be immersed.</p>		Solder Temperature	245±5°C	Immersing speed	25mm/s	Time	5±0.5 sec.
Solder Temperature	245±5°C							
Immersing speed	25mm/s							
Time	5±0.5 sec.							

▶ This catalog contains the typical specification only due to the limitation of space. When you consider the purchase of our products, please check our specification. For details of each product (characteristics graph, reliability information, precautions for use, and so on), see our Web site (<http://www.ty-top.com/>).

15. Resistance to soldering heat		
Specified Value	MB series	Inductance change : Within $\pm 10\%$ No significant abnormality in appearance.
	MB-H series	
Test Methods and Remarks	The test sample shall be exposed to reflow oven at 230°C for 40 seconds, with peak temperature at 260+0/-5°C for 5 seconds, 3 times. Test board material : Glass epoxy-resin Test board thickness : 1.0mm Recovery : At least 2hrs of recovery under the standard condition after the test, followed by the measurement within 48hrs.	

16. Thermal shock																																						
Specified Value	MB series	Inductance change : Within $\pm 10\%$ No significant abnormality in appearance.																																				
	MB-H series																																					
Test Methods and Remarks	<p>MB series: The test samples shall be soldered to the test board by the reflow. The test samples shall be placed at specified temperature for specified time by step 1 to step 4 as shown in below table in sequence. The temperature cycle shall be repeated 100 cycles.</p> <table border="1"> <thead> <tr> <th colspan="3">Conditions of 1 cycle</th> </tr> <tr> <th>Step</th> <th>Temperature (°C)</th> <th>Duration (min)</th> </tr> </thead> <tbody> <tr> <td>1</td> <td>-40±3</td> <td>30±3</td> </tr> <tr> <td>2</td> <td>Room temperature</td> <td>Within 3</td> </tr> <tr> <td>3</td> <td>+85±2</td> <td>30±3</td> </tr> <tr> <td>4</td> <td>Room temperature</td> <td>Within 3</td> </tr> </tbody> </table> <p>Recovery : At least 2hrs of recovery under the standard condition after the test, followed by the measurement within 48hrs.</p>	Conditions of 1 cycle			Step	Temperature (°C)	Duration (min)	1	-40±3	30±3	2	Room temperature	Within 3	3	+85±2	30±3	4	Room temperature	Within 3	<p>MB-H series: The test samples shall be soldered to the test board by the reflow. The test samples shall be placed at specified temperature for specified time by step 1 to step 4 as shown in below table in sequence. The temperature cycle shall be repeated 100 cycles.</p> <table border="1"> <thead> <tr> <th colspan="3">Conditions of 1 cycle</th> </tr> <tr> <th>Step</th> <th>Temperature (°C)</th> <th>Duration (min)</th> </tr> </thead> <tbody> <tr> <td>1</td> <td>-40±3</td> <td>30±3</td> </tr> <tr> <td>2</td> <td>Room temperature</td> <td>Within 3</td> </tr> <tr> <td>3</td> <td>+125±2</td> <td>30±3</td> </tr> <tr> <td>4</td> <td>Room temperature</td> <td>Within 3</td> </tr> </tbody> </table> <p>Recovery : At least 2hrs of recovery under the standard condition after the test, followed by the measurement within 48hrs.</p>	Conditions of 1 cycle			Step	Temperature (°C)	Duration (min)	1	-40±3	30±3	2	Room temperature	Within 3	3	+125±2	30±3	4	Room temperature	Within 3
	Conditions of 1 cycle																																					
Step	Temperature (°C)	Duration (min)																																				
1	-40±3	30±3																																				
2	Room temperature	Within 3																																				
3	+85±2	30±3																																				
4	Room temperature	Within 3																																				
Conditions of 1 cycle																																						
Step	Temperature (°C)	Duration (min)																																				
1	-40±3	30±3																																				
2	Room temperature	Within 3																																				
3	+125±2	30±3																																				
4	Room temperature	Within 3																																				

17. Damp heat														
Specified Value	MB series	Inductance change : Within $\pm 10\%$ No significant abnormality in appearance.												
	MB-H series													
Test Methods and Remarks	<p>MB series: The test samples shall be soldered to the test board by the reflow. The test samples shall be placed in thermostatic oven set at specified temperature and humidity as shown in below table.</p> <table border="1"> <tbody> <tr> <td>Temperature</td> <td>60±2°C</td> </tr> <tr> <td>Humidity</td> <td>90~95%RH</td> </tr> <tr> <td>Time</td> <td>1000+24/-0 hour</td> </tr> </tbody> </table> <p>Recovery : At least 2hrs of recovery under the standard condition after the test, followed by the measurement within 48hrs.</p>	Temperature	60±2°C	Humidity	90~95%RH	Time	1000+24/-0 hour	<p>MB-H series: The test samples shall be soldered to the test board by the reflow. The test samples shall be placed in thermostatic oven set at specified temperature and humidity as shown in below table.</p> <table border="1"> <tbody> <tr> <td>Temperature</td> <td>85±2°C</td> </tr> <tr> <td>Humidity</td> <td>85%RH</td> </tr> <tr> <td>Time</td> <td>1000+24/-0 hour</td> </tr> </tbody> </table> <p>Recovery : At least 2hrs of recovery under the standard condition after the test, followed by the measurement within 48hrs.</p>	Temperature	85±2°C	Humidity	85%RH	Time	1000+24/-0 hour
	Temperature	60±2°C												
Humidity	90~95%RH													
Time	1000+24/-0 hour													
Temperature	85±2°C													
Humidity	85%RH													
Time	1000+24/-0 hour													

18. Loading under damp heat																		
Specified Value	MB series	Inductance change : Within $\pm 10\%$ No significant abnormality in appearance.																
	MB-H series																	
Test Methods and Remarks	<p>MB series: The test samples shall be soldered to the test board by the reflow. The test samples shall be placed in thermostatic oven set at specified temperature and humidity and applied the rated current continuously as shown in below table.</p> <table border="1"> <tbody> <tr> <td>Temperature</td> <td>60±2°C</td> </tr> <tr> <td>Humidity</td> <td>90~95%RH</td> </tr> <tr> <td>Applied current</td> <td>Rated current</td> </tr> <tr> <td>Time</td> <td>1000+24/-0 hour</td> </tr> </tbody> </table> <p>Recovery : At least 2hrs of recovery under the standard condition after the test, followed by the measurement within 48hrs.</p>	Temperature	60±2°C	Humidity	90~95%RH	Applied current	Rated current	Time	1000+24/-0 hour	<p>MB-H series: The test samples shall be soldered to the test board by the reflow. The test samples shall be placed in thermostatic oven set at specified temperature and humidity and applied the rated current continuously as shown in below table.</p> <table border="1"> <tbody> <tr> <td>Temperature</td> <td>85±2°C</td> </tr> <tr> <td>Humidity</td> <td>85%RH</td> </tr> <tr> <td>Applied current</td> <td>Rated current</td> </tr> <tr> <td>Time</td> <td>1000+24/-0 hour</td> </tr> </tbody> </table> <p>Recovery : At least 2hrs of recovery under the standard condition after the test, followed by the measurement within 48hrs.</p>	Temperature	85±2°C	Humidity	85%RH	Applied current	Rated current	Time	1000+24/-0 hour
	Temperature	60±2°C																
Humidity	90~95%RH																	
Applied current	Rated current																	
Time	1000+24/-0 hour																	
Temperature	85±2°C																	
Humidity	85%RH																	
Applied current	Rated current																	
Time	1000+24/-0 hour																	

19. Low temperature life test						
Specified Value	MB series	Inductance change : Within $\pm 10\%$ No significant abnormality in appearance.				
	MB-H series					
Test Methods and Remarks	<p>The test samples shall be soldered to the test board by the reflow. After that, the test samples shall be placed at test conditions as shown in below table.</p> <table border="1"> <tbody> <tr> <td>Temperature</td> <td>-40±2°C</td> </tr> <tr> <td>Time</td> <td>1000+24/-0 hour</td> </tr> </tbody> </table> <p>Recovery : At least 2hrs of recovery under the standard condition after the test, followed by the measurement within 48hrs.</p>		Temperature	-40±2°C	Time	1000+24/-0 hour
Temperature	-40±2°C					
Time	1000+24/-0 hour					

20. High temperature life test		
Specified Value	MB series	Inductance change : Within $\pm 10\%$ No significant abnormality in appearance.
	MB-H series	
Test Methods and Remarks	The test samples shall be soldered to the test board by the reflow. After that, the test samples shall be placed at test conditions as shown in below table.	
	Temperature	$85 \pm 2^\circ\text{C}$
	Time	$1000 \pm 24 / -0$ hour
Recovery : At least 2hrs of recovery under the standard condition after the test, followed by the measurement within 48hrs.		

21. Loading at high temperature life test		
Specified Value	MB series	—
	MB-H series	

22. Standard condition		
Specified Value	MB series	Standard test condition : Unless otherwise specified, temperature is $20 \pm 15^\circ\text{C}$ and $65 \pm 20\%$ of relative humidity. When there is any question concerning measurement result: In order to provide correlation data, the test shall be condition of $20 \pm 2^\circ\text{C}$ of temperature, $65 \pm 5\%$ relative humidity. Inductance is in accordance with our measured value.
	MB-H series	

METAL WIRE-WOUND CHIP POWER INDUCTORS

(MCOIL™ MB SERIES / MCOIL™ MB-H SERIES)

PRECAUTIONS

1. Circuit Design	
Precautions	<ul style="list-style-type: none"> ◆ Operating environment <ol style="list-style-type: none"> 1. The products described in this specification are intended for use in general electronic equipment, (office supply equipment, telecommunications systems, measuring equipment, and household equipment). They are not intended for use in mission-critical equipment or systems requiring special quality and high reliability (traffic systems, safety equipment, aerospace systems, nuclear control systems and medical equipment including life-support systems,) where product failure might result in loss of life, injury or damage. For such uses, contact TAIYO YUDEN Sales Department in advance.
2. PCB Design	
Precautions	<ul style="list-style-type: none"> ◆ Land pattern design <ol style="list-style-type: none"> 1. Please refer to a recommended land pattern.
Technical considerations	<ul style="list-style-type: none"> ◆ Land pattern design Surface Mounting <ul style="list-style-type: none"> • Mounting and soldering conditions should be checked beforehand. • Applicable soldering process to this products is reflow soldering only.
3. Considerations for automatic placement	
Precautions	<ul style="list-style-type: none"> ◆ Adjustment of mounting machine <ol style="list-style-type: none"> 1. Excessive impact load should not be imposed on the products when mounting onto the PC boards. 2. Mounting and soldering conditions should be checked beforehand.
Technical considerations	<ul style="list-style-type: none"> ◆ Adjustment of mounting machine <ol style="list-style-type: none"> 1. When installing products, care should be taken not to apply distortion stress as it may deform the products.
4. Soldering	
Precautions	<ul style="list-style-type: none"> ◆ Reflow soldering <ol style="list-style-type: none"> 1. Please contact any of our offices for a reflow soldering, and refer to the recommended condition specified. 2. The product shall be used reflow soldering only. 3. Please do not add any stress to a product until it returns in normal temperature after reflow soldering. ◆ Lead free soldering <ol style="list-style-type: none"> 1. When using products with lead free soldering, we request to use them after confirming adhesion, temperature of resistance to soldering heat, soldering etc sufficiently.
Technical considerations	<ul style="list-style-type: none"> ◆ Reflow soldering <ol style="list-style-type: none"> 1. If products are used beyond the range of the recommended conditions, heat stresses may deform the products, and consequently degrade the reliability of the products. <p>Recommended reflow condition (Pb free solder)</p> <p>Temperature [°C]</p> <p>Heating Time [sec]</p> <p>150~180</p> <p>90 ± 30sec</p> <p>230°C min</p> <p>40sec max</p> <p>5sec max</p> <p>Peak: 260+0/-5°C</p>
5. Cleaning	
Precautions	<ul style="list-style-type: none"> ◆ Cleaning conditions <ol style="list-style-type: none"> 1. Washing by supersonic waves shall be avoided.
Technical considerations	<ul style="list-style-type: none"> ◆ Cleaning conditions <ol style="list-style-type: none"> 1. If washed by supersonic waves, the products might be broken.

▶ This catalog contains the typical specification only due to the limitation of space. When you consider the purchase of our products, please check our specification. For details of each product (characteristics graph, reliability information, precautions for use, and so on), see our Web site (<http://www.ty-top.com/>).

6. Handling	
Precautions	<ul style="list-style-type: none"> ◆ Handling <ol style="list-style-type: none"> 1. Keep the product away from all magnets and magnetic objects. ◆ Breakaway PC boards (splitting along perforations) <ol style="list-style-type: none"> 1. When splitting the PC board after mounting product, care should be taken not to give any stresses of deflection or twisting to the board. 2. Board separation should not be done manually, but by using the appropriate devices. ◆ Mechanical considerations <ol style="list-style-type: none"> 1. Please do not give the product any excessive mechanical shocks. 2. Please do not add any shock and power to a product in transportation. ◆ Pick-up pressure <ol style="list-style-type: none"> 1. Please do not push to add any pressure to a winding part. Please do not give any shock and push into a ferrite core exposure part. ◆ Packing <ol style="list-style-type: none"> 1. Please avoid accumulation of a packing box as much as possible.
Technical considerations	<ul style="list-style-type: none"> ◆ Handling <ol style="list-style-type: none"> 1. There is a case that a characteristic varies with magnetic influence. ◆ Breakaway PC boards (splitting along perforations) <ol style="list-style-type: none"> 1. The position of the product on PCBs shall be carefully considered to minimize the stress caused from splitting of the PCBs. ◆ Mechanical considerations <ol style="list-style-type: none"> 1. There is a case to be damaged by a mechanical shock. 2. There is a case to be broken by the handling in transportation. ◆ Pick-up pressure <ol style="list-style-type: none"> 1. Damage and a characteristic can vary with an excessive shock or stress. ◆ Packing <ol style="list-style-type: none"> 1. If packing boxes are accumulated, that could cause a deformation on packing tapes or a damage on the products.
7. Storage conditions	
Precautions	<ul style="list-style-type: none"> ◆ Storage <ol style="list-style-type: none"> 1. To maintain the solderability of terminal electrodes and to keep the packing material in good condition, temperature and humidity in the storage area should be controlled. <ul style="list-style-type: none"> ▪ Recommended conditions <ul style="list-style-type: none"> Ambient temperature : 0~40°C Humidity : Below 70% RH ▪ The ambient temperature must be kept below 30°C. Even under ideal storage conditions, solderability of products electrodes may decrease as time passes. <ul style="list-style-type: none"> For this reason, product should be used within 6 months from the time of delivery. In case of storage over 6 months, solderability shall be checked before actual usage.
Technical considerations	<ul style="list-style-type: none"> ◆ Storage <ol style="list-style-type: none"> 1. Under a high temperature and humidity environment, problems such as reduced solderability caused by oxidation of terminal electrodes and deterioration of taping/packaging materials may take place.