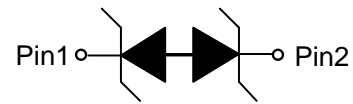

**ESD5651N**
**4.5V, Single Li-ion Battery Port Surge Protector**
<http://www.sh-willsemi.com>
**Descriptions**

The ESD5651N is a bi-directional TVS (Transient Voltage Suppressor). It is specifically designed to protect sensitive electronic components which are connected to power lines, from over-stress caused by ESD (Electrostatic Discharge), EFT (Electrical Fast Transients) and Lightning.

The ESD5651N may be used to provide ESD protection up to  $\pm 30\text{kV}$  (contact and air discharge) according to IEC61000-4-2, and withstand peak pulse current up to 35A (8/20 $\mu\text{s}$ ) according to IEC61000-4-5.

The ESD5651N is available in DFN1006-2L package. Standard products are Pb-free and Halogen-free.

**DFN1006-2L (Bottom View)**

**Circuit diagram**
**Features**

- Reverse stand-off voltage:  $\pm 4.5\text{V}$  Max.
- Transient protection for each line according to IEC61000-4-2 (ESD):  $\pm 30\text{kV}$  (contact and air discharge)  
IEC61000-4-4 (EFT): 40A (5/50ns)  
IEC61000-4-5 (surge): 35A (8/20 $\mu\text{s}$ )
- Capacitance:  $C_J = 65\text{pF}$  typ.
- Low leakage current
- Low clamping voltage:  $V_{CL} = 6.5\text{V}$  typ. @  $I_{PP} = 16\text{A}$  (TLP)
- Solid-state silicon technology



3 = Device code

\* = Month code (A~Z)

**Marking (Top View)**
**Applications**

- Power lines
- Cellular handsets
- Tablets
- Microprocessors
- Portable Electronics

**Order information**

Device	Package	Shipping
ESD5651N-2/TR	DFN1006-2L	10000/Tape&Reel

**Absolute maximum ratings**

Parameter	Symbol	Rating	Unit
Peak pulse power ( $t_p = 8/20\mu s$ )	$P_{pk}$	525	W
Peak pulse current ( $t_p = 8/20\mu s$ )	$I_{PP}$	35	A
ESD according to IEC61000-4-2 air discharge	$V_{ESD}$	$\pm 30$	kV
ESD according to IEC61000-4-2 contact discharge		$\pm 30$	
Junction temperature	$T_J$	125	$^{\circ}C$
Operating temperature	$T_{OP}$	-40~85	$^{\circ}C$
Lead temperature	$T_L$	260	$^{\circ}C$
Storage temperature	$T_{STG}$	-55~150	$^{\circ}C$

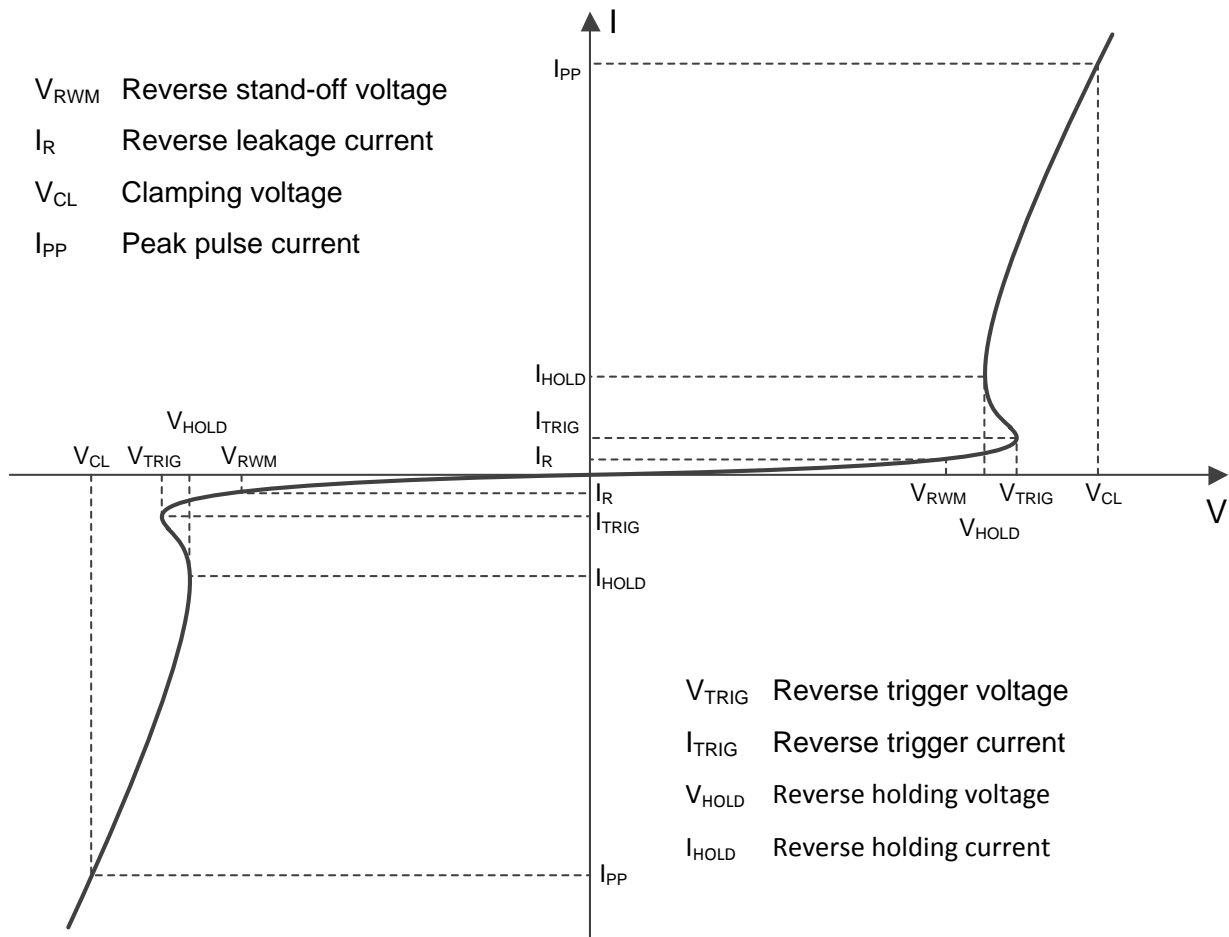
**Electrical characteristics ( $T_A=25^{\circ}C$ , unless otherwise noted)**

**Definitions of electrical characteristics**

**Electrical characteristics (T<sub>A</sub>=25 °C, unless otherwise noted)**

Parameter	Symbol	Condition	Min.	Typ.	Max.	Unit
Reverse stand-off voltage	V <sub>RWM</sub>				±4.5	V
Reverse leakage current	I <sub>R</sub>	V <sub>RWM</sub> = 4.5V			1	μA
Reverse trigger voltage	V <sub>TRIG</sub>	I <sub>TRIG</sub> = 2μA	4.7			V
Reverse holding voltage	V <sub>HOLD</sub>	I <sub>HOLD</sub> = 50mA	4.6			V
Clamping voltage <sup>1)</sup>	V <sub>CL</sub>	I <sub>PP</sub> = 16A, t <sub>p</sub> = 100ns		6.5		V
Clamping voltage <sup>2)</sup>	V <sub>CL</sub>	V <sub>ESD</sub> = 8kV		6.5		V
Clamping voltage <sup>3)</sup>	V <sub>CL</sub>	I <sub>PP</sub> = 1A, t <sub>p</sub> = 8/20μs			6	V
		I <sub>PP</sub> = 20A, t <sub>p</sub> = 8/20μs			11	V
		I <sub>PP</sub> = 35A, t <sub>p</sub> = 8/20μs			15	V
Dynamic resistance <sup>1)</sup>	R <sub>DYN</sub>			0.12		Ω
Junction capacitance	C <sub>J</sub>	V <sub>R</sub> = 0V, f = 1MHz		65	80	pF
		V <sub>R</sub> = 4.5V, f = 1MHz		45	60	pF

**Notes:**

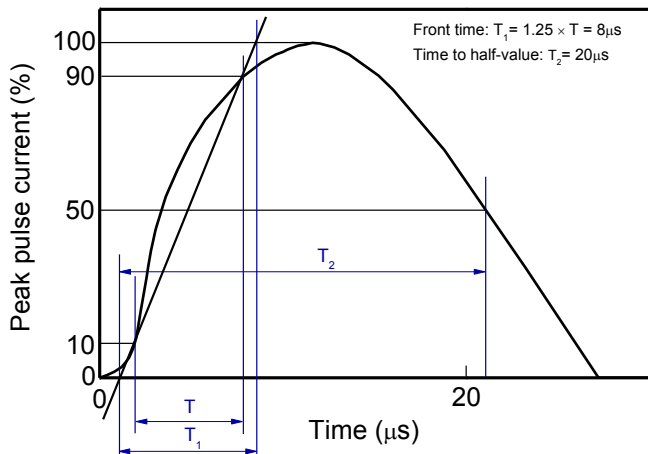
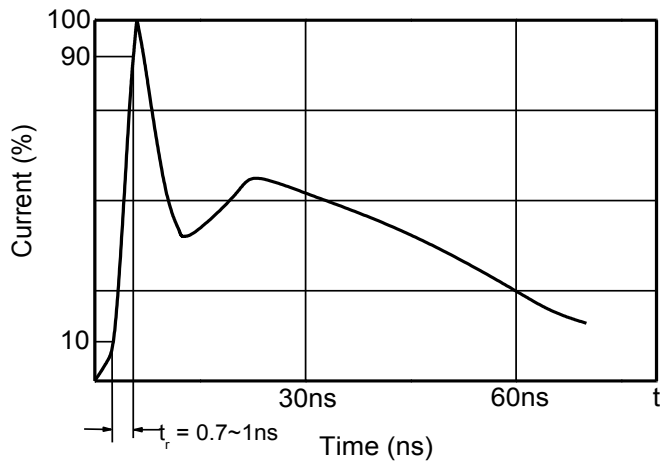
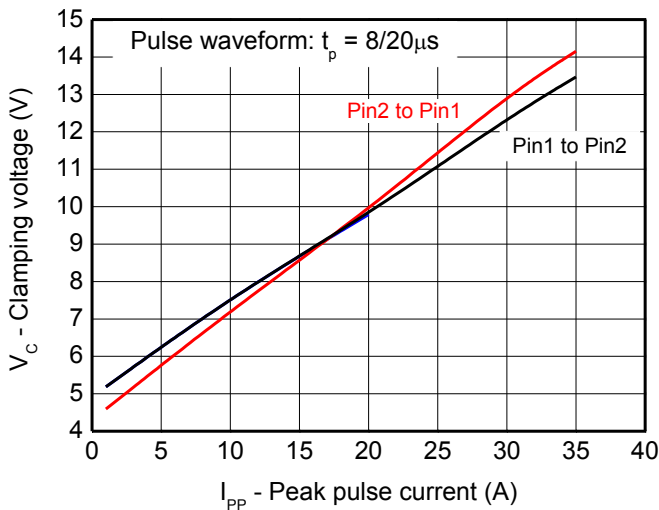
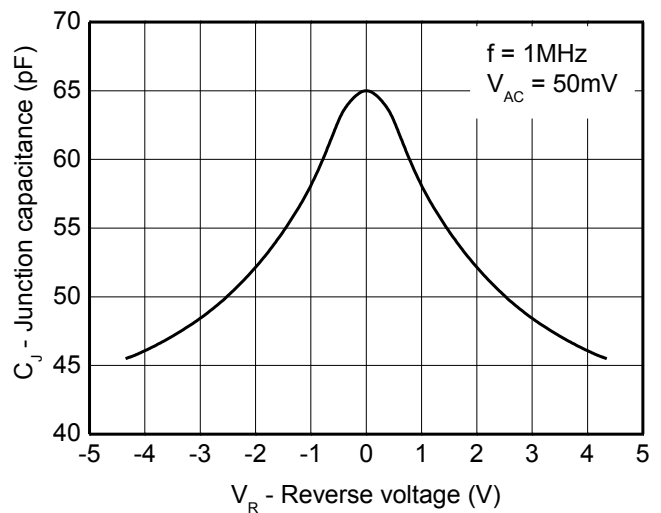
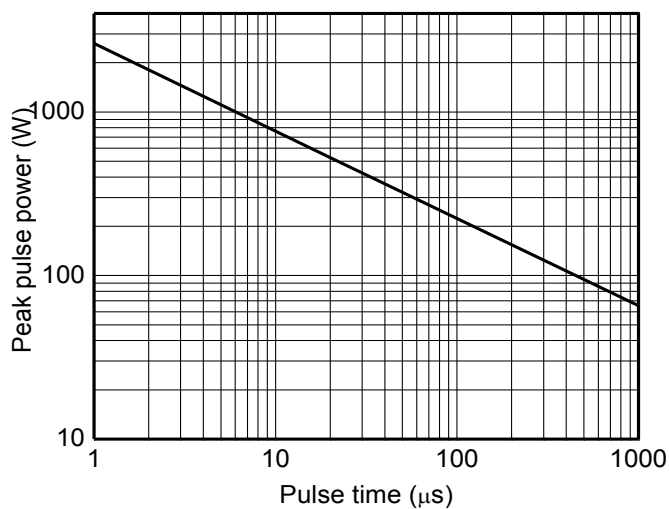
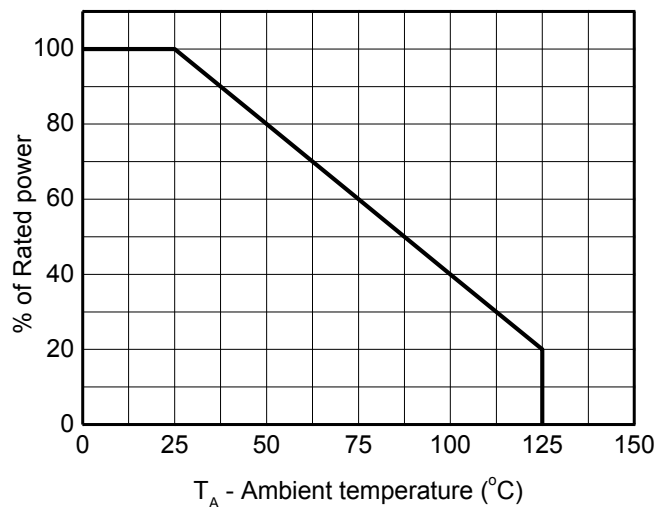
- 1) TLP parameter: Z<sub>0</sub> = 50Ω, t<sub>p</sub> = 100ns, t<sub>r</sub> = 2ns, averaging window from 60ns to 80ns. R<sub>DYN</sub> is calculated from 4A to 16A.
- 2) Contact discharge mode, according to IEC61000-4-2.
- 3) Non-repetitive current pulse, according to IEC61000-4-5.

**Typical characteristics ( $T_A=25^\circ\text{C}$ , unless otherwise noted)**

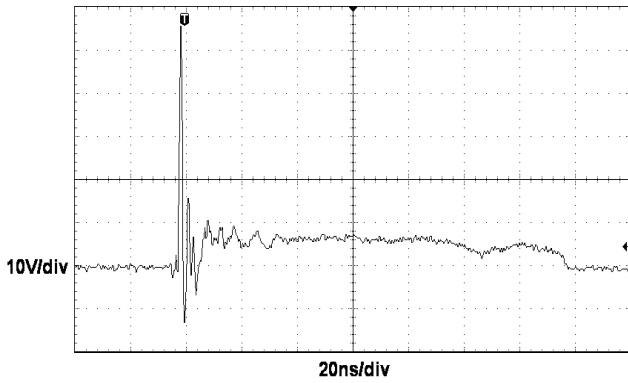
**8/20 $\mu\text{s}$  waveform per IEC61000-4-5**

**Contact discharge current waveform per IEC61000-4-2**

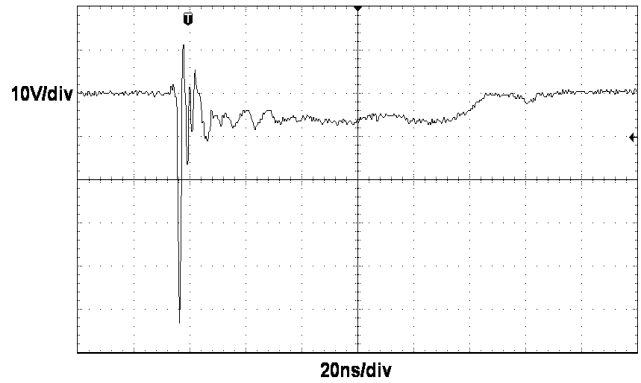
**Clamping voltage vs. Peak pulse current**

**Capacitance vs. Reverse voltage**

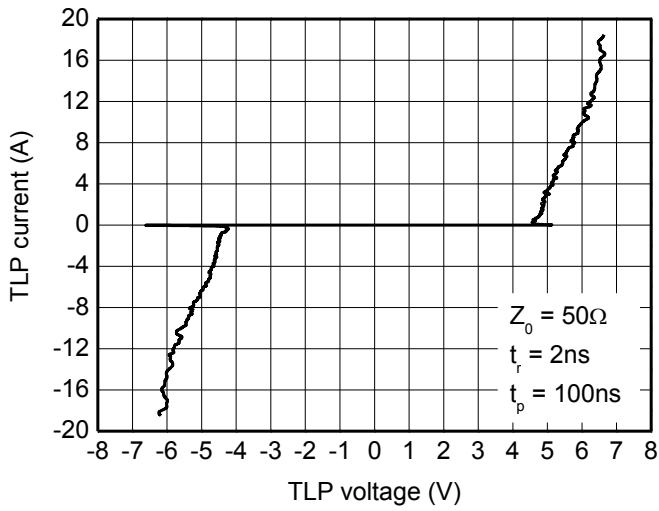
**Non-repetitive peak pulse power vs. Pulse time**

**Power derating vs. Ambient temperature**

**Typical characteristics ( $T_A=25^{\circ}\text{C}$ , unless otherwise noted)**

**ESD clamping**  
 (+8kV contact discharge per IEC61000-4-2)



**ESD clamping**  
 (-8kV contact discharge per IEC61000-4-2)

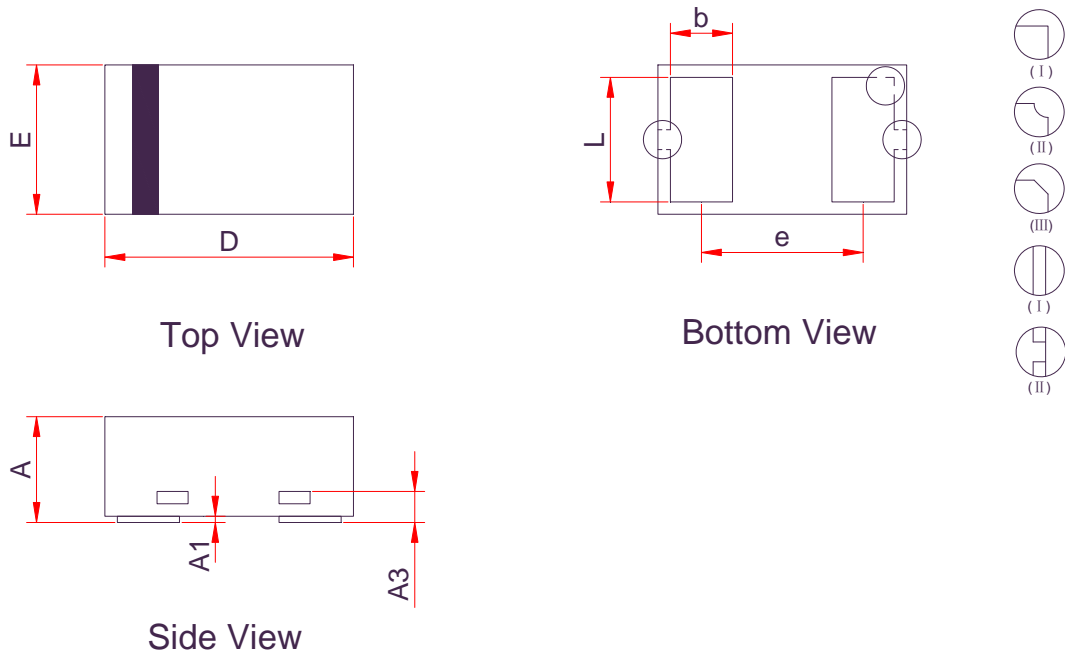

**TLP Measurement**

**PACKAGE OUTLINE DIMENSIONS**
**DFN1006-2L**

Symbol	Dimensions in Millimeters		
	Min.	Typ.	Max.
A	0.34	0.45	0.53
A1	0.00	0.02	0.05
A3	0.12 Ref.		
D	0.95	1.00	1.08
E	0.55	0.60	0.68
b	0.20	0.25	0.30
L	0.45	0.50	0.55
e	0.65 BSC		

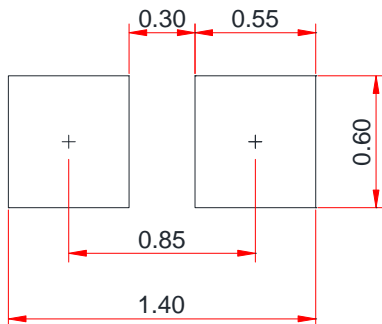
**Recommended land pattern (Unit: mm)**

**Notes:**

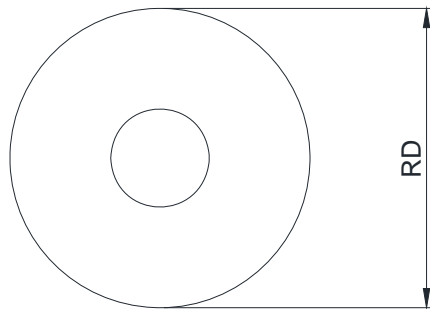
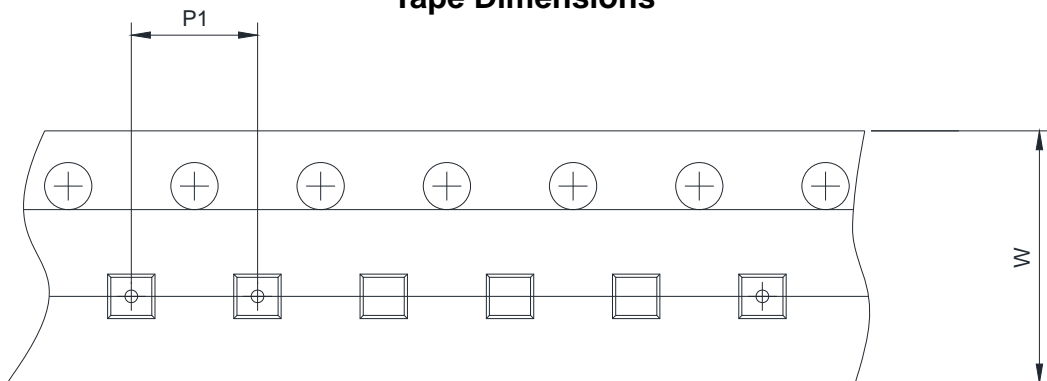
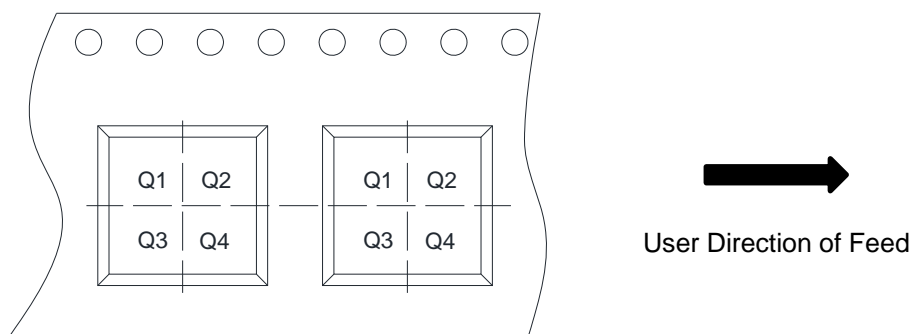
This recommended land pattern is for reference purposes only. Please consult your manufacturing group to ensure your PCB design guidelines are met.

**TAPE AND REEL INFORMATION**
**Reel Dimensions**

**Tape Dimensions**

**Quadrant Assignments For PIN1 Orientation In Tape**

RD	Reel Dimension	<input checked="" type="checkbox"/> 7inch	<input type="checkbox"/> 13inch
W	Overall width of the carrier tape	<input checked="" type="checkbox"/> 8mm	<input type="checkbox"/> 12mm <input type="checkbox"/> 16mm
P1	Pitch between successive cavity centers	<input checked="" type="checkbox"/> 2mm	<input type="checkbox"/> 4mm <input type="checkbox"/> 8mm
Pin1	Pin1 Quadrant	<input checked="" type="checkbox"/> Q1	<input checked="" type="checkbox"/> Q2 <input type="checkbox"/> Q3 <input type="checkbox"/> Q4