

# SI2301A

20V P-Channel Enhancement-Mode MOSFET

**VDS= -20V**

**RDS(ON), Vgs@-4.5V, Ids@-3.0A < 110mΩ**

**RDS(ON), Vgs@-2.5V, Ids@-2.0A < 140mΩ**

## Features

Advanced trench process technology

High Density Cell Design For Ultra Low On-Resistance

## Package Dimensions

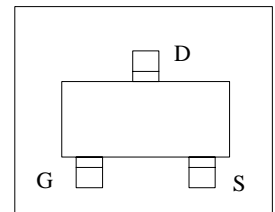
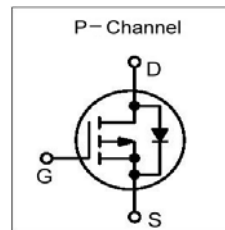
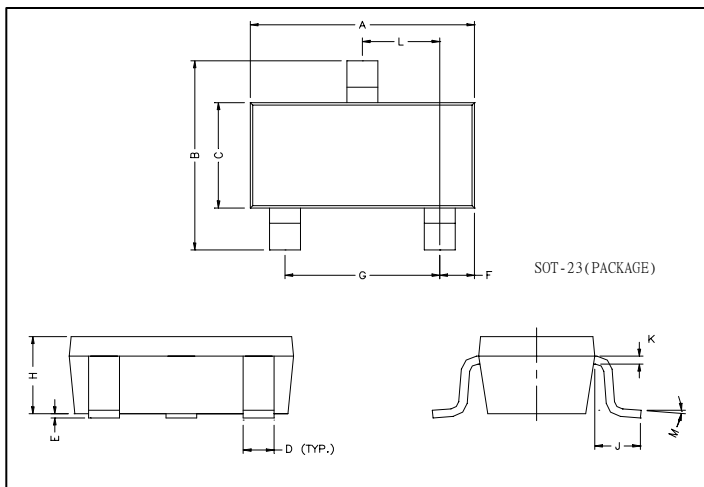

REF.	Millimeter		REF.	Millimeter	
	Min.	Max.		Min.	Max.
A	2.70	3.10	G	1.90	REF.
B	2.40	2.80	H	1.00	1.30
C	1.40	1.60	K	0.10	0.20
D	0.35	0.50	J	0.40	-
E	0	0.10	L	0.85	1.15
F	0.45	0.55	M	0°	10°

## Maximum Ratings and Thermal Characteristics (TA = 25°C unless otherwise noted)

Parameter	Symbol	Limit	Unit	
Drain-Source Voltage	$V_{DS}$	-20	V	
Gate-Source Voltage	$V_{GS}$	±10		
Continuous Drain Current	$I_D$	-3	A	
Pulsed Drain Current <sup>1)</sup>	$I_{DM}$	-10		
Maximum Power Dissipation <sup>2)</sup>		TA = 25°	1.25	W
		TA = 75°C	0.8	
Operating Junction and Storage Temperature Range	$T_J, T_{stg}$	-55 to 150	°C	
Junction-to-Ambient Thermal Resistance (PCB mounted) <sup>2)</sup>	$R_{thJA}$	100	°C/W	
Junction-to-Ambient Thermal Resistance (PCB mounted) <sup>3)</sup>		166		

### Notes

- 1) Pulse width limited by maximum junction temperature.
- 2) Surface Mounted on FR4 Board,  $t \leq 5$  sec.
- 3) Surface Mounted on FR4 Board.

## ELECTRICAL CHARACTERISTICS

Parameter	Symbol	Test Condition	Min.	Typ.	Max.	Unit
<b>Static</b>						
Drain-Source Breakdown Voltage	$BV_{DSS}$	$V_{GS} = 0V, I_D = -250\mu A$	-20			V
Drain-Source On-State Resistance <sup>1)</sup>	$R_{DS(on)}$	$V_{GS} = -4.5V, I_D = -3.0A$		64	110	$m\Omega$
		$V_{GS} = -2.5V, I_D = -2.0A$		89	140	
Gate Threshold Voltage	$V_{GS(th)}$	$V_{DS} = V_{GS}, I_D = -250\mu A$	-0.4		-1	V
Zero Gate Voltage Drain Current 0	$I_{DSS}$	$V_{DS} = -20V, V_{GS} = 0V$			-1	$\mu A$
		$V_{DS} = -16V, V_{GS} = 0V, T_J = 55^\circ C$			-10	
Gate Body Leakage	$I_{GSS}$	$V_{GS} = \pm 10V, V_{DS} = 0V$			$\pm 100$	nA
Forward Transconductance <sup>1)</sup>	$g_{fs}$	$V_{DS} = -5V, I_D = -2.8A$		6.5	—	S
<b>Dynamic</b>						
Total Gate Charge	$Q_g$	$V_{DS} = -6V, I_D \cong -2.3A$ $V_{GS} = -4.5V$		5.8		nC
Gate-Source Charge	$Q_{gs}$			0.85		
Gate-Drain Charge	$Q_{gd}$			1.7		
Turn-On Delay Time	$t_{d(on)}$	$V_{DD} = -6V, R_L = 6\Omega$ $I_D \cong -1.0A, V_{GEN} = -4.5V$ $R_G = 6\Omega$		13		ns
Turn-On Rise Time	$t_r$			36		
Turn-Off Delay Time	$t_{d(off)}$			42		
Turn-Off Fall Time	$t_f$			34		
Input Capacitance	$C_{iss}$	$V_{DS} = -6V, V_{GS} = 0V$ $f = 1.0 MHz$		415		pF
Output Capacitance	$C_{oss}$			223		
Reverse Transfer Capacitance	$C_{rss}$			87		
<b>Source-Drain Diode</b>						
Max. Diode Forward Current	$I_S$				-1.6	A
Diode Forward Voltage	$V_{SD}$	$I_S = -1.0A, V_{GS} = 0V$		-0.8	-1.2	V

<sup>1)</sup> Pulse test: pulse width  $\leq 300\mu s$ , duty cycle  $\leq 2\%$

TYPICAL ELECTRICAL AND THERMAL CHARACTERISTICS

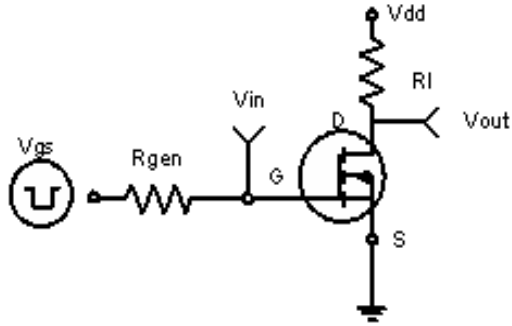

Figure 1: Switching Test Circuit

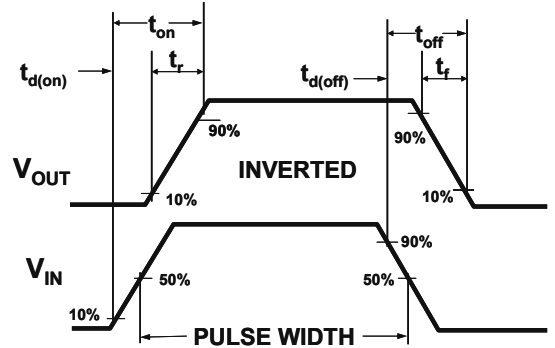
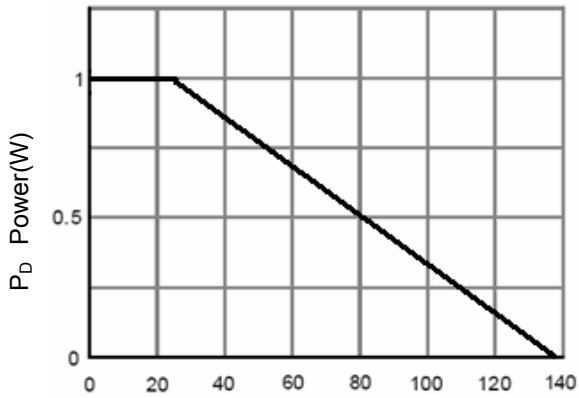
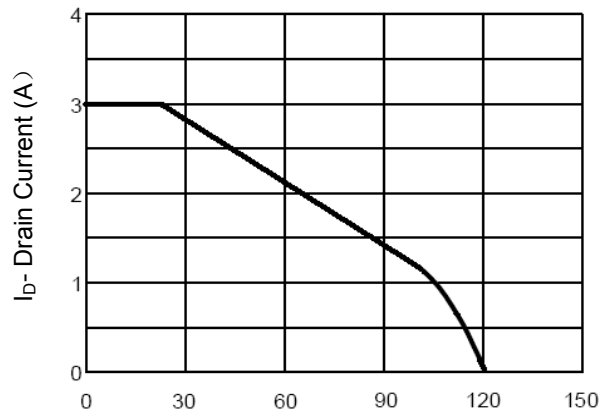

Figure 2: Switching Waveforms



T<sub>J</sub>-Junction Temperature(°C)  
Figure 3 Power Dissipation



T<sub>J</sub>-Junction Temperature(°C)  
Figure 4 Drain Current

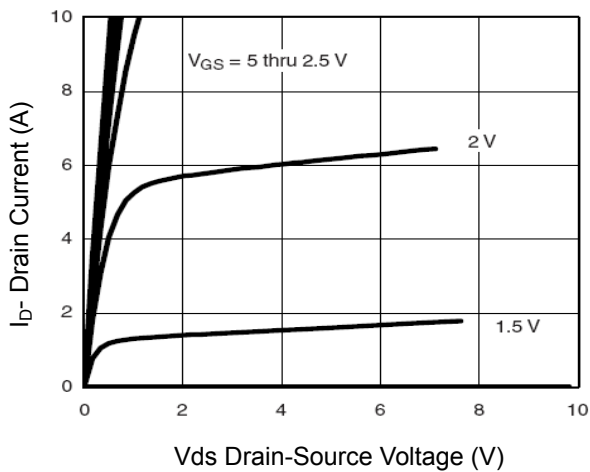

V<sub>GS</sub> = 5 thru 2.5 V  
V<sub>GS</sub> = 2 V  
V<sub>GS</sub> = 1.5 V  
V<sub>ds</sub> Drain-Source Voltage (V)  
Figure 5 Output CHARACTERISTICS

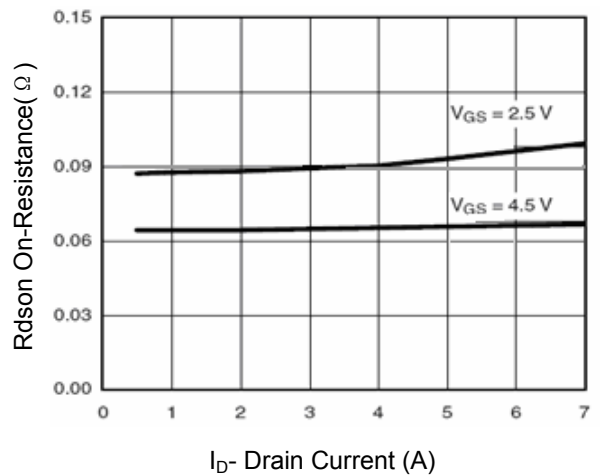

V<sub>GS</sub> = 2.5 V  
V<sub>GS</sub> = 4.5 V  
I<sub>D</sub>- Drain Current (A)  
Figure 6 Drain-Source On-Resistance

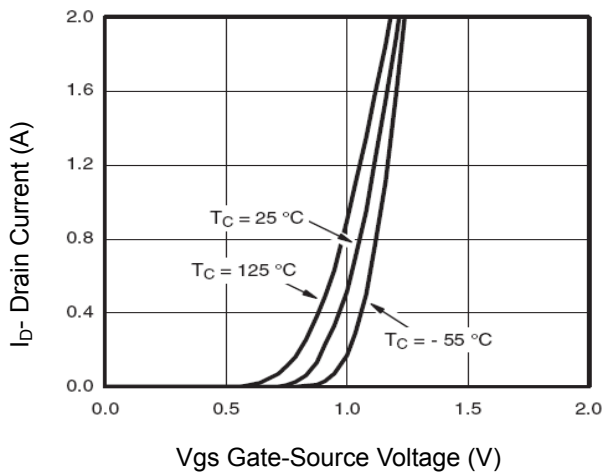

**Figure 7 Transfer Characteristics**

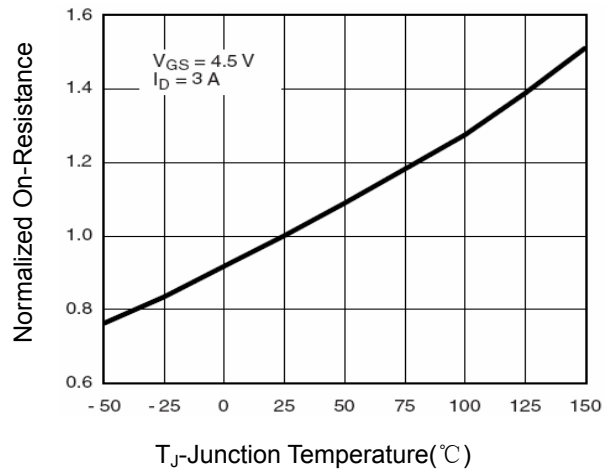

**Figure 8 Drain-Source On-Resistance**

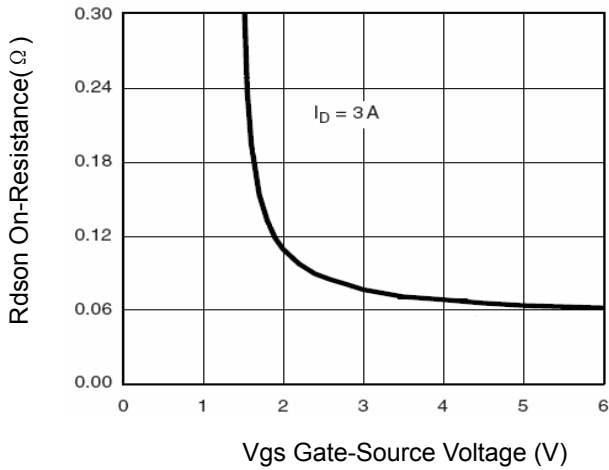

**Figure 9 Rdson vs Vgs**

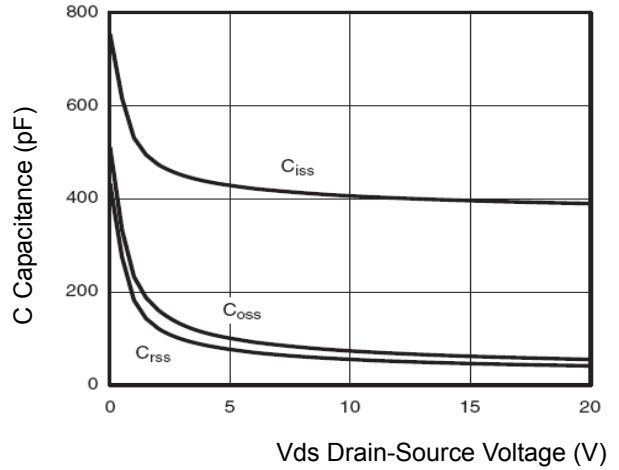

**Figure 10 Capacitance vs Vds**

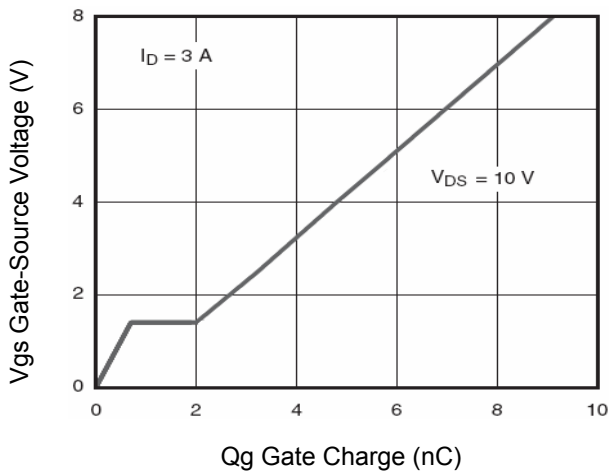

**Figure 11 Gate Charge**

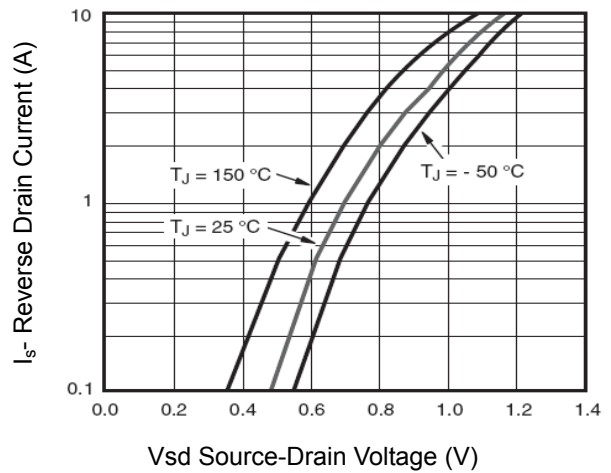

**Figure 12 Source-Drain Diode Forward**

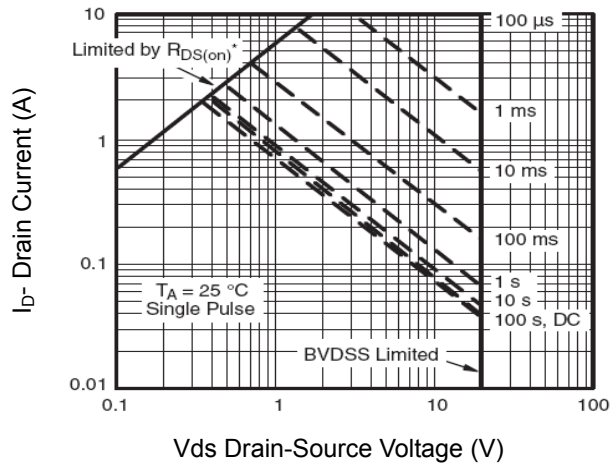

Figure 13 Safe Operation Area

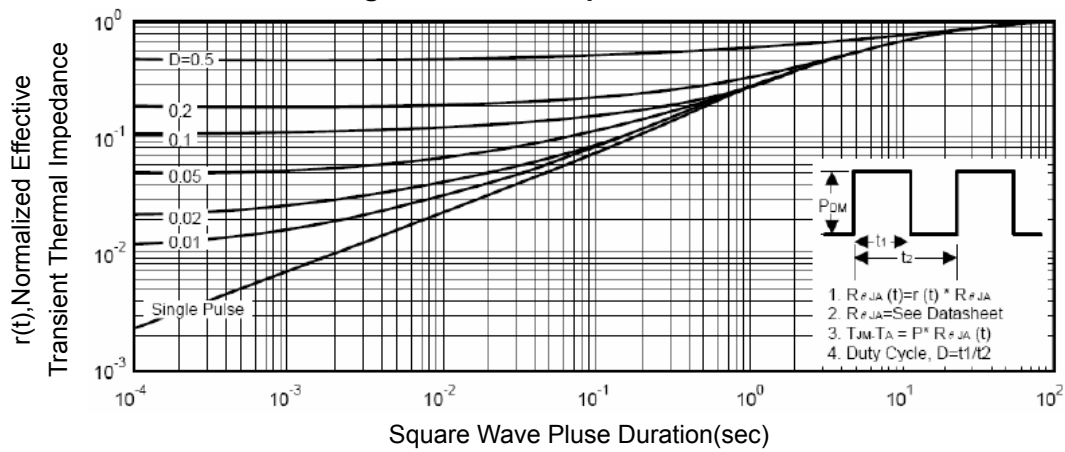

Figure 14 Normalized Maximum Transient Thermal Impedance