

Features

- Directly mounts to target PCB (needs tooling holes) with hardware
- Minimum real estate required
- Compression plate distributes forces evenly
- Clamshell lid

Materials:

- ① Clam Shell Lid: Black anodized Aluminum. Height = 20 mm.
- ② Socket Base: Black anodized Aluminum. Height = 6 mm.
- ③ Compression Plate: Black anodized Aluminum. Thickness = 12 mm.
- ④ Compression Screw: Clear anodized Aluminum. Height = 27 mm, Fluted Knob
- ⑤ Pogo Pin:
Plungers - Hardened Steel/ Gold plated
Barrel - Copper Alloy/ Gold plated
Spring - Stainless Steel/ Gold wire
- ⑥ Pogo Pin Guides: Ceramic filled PEEK
- ⑦ Socket Base Screw: Socket Head Cap Screw, alloy steel with black oxide finish, 0-80 Thread, 5/8" long.
- ⑧ Pogo Pin Guide Screw: Pan head phillips, 18-8 SS, 0-80 thread, 3/16" long.
- ⑨ Latch: Black anodized Aluminum.
- ⑩ Backing Plate: Black anodized Aluminum
- ⑪ Insulation Plate: FR4/G10

All Tolerances: ±0.125mm (unless stated otherwise). Materials and specifications are subject to change without notice.

	SS-QFE128SD-02 Drawing	Status: Released	Scale: N/A	Rev: A
	© 2010 IRONWOOD ELECTRONICS, INC. Tele: (800) 404-0204 www.ironwoodelectronics.com	Drawing: V. Panavala	Date: 10/14/2010	
		File: SS-QFE128SD-02 Dwg	Modified:	

Recommended PCB Layout
Top View

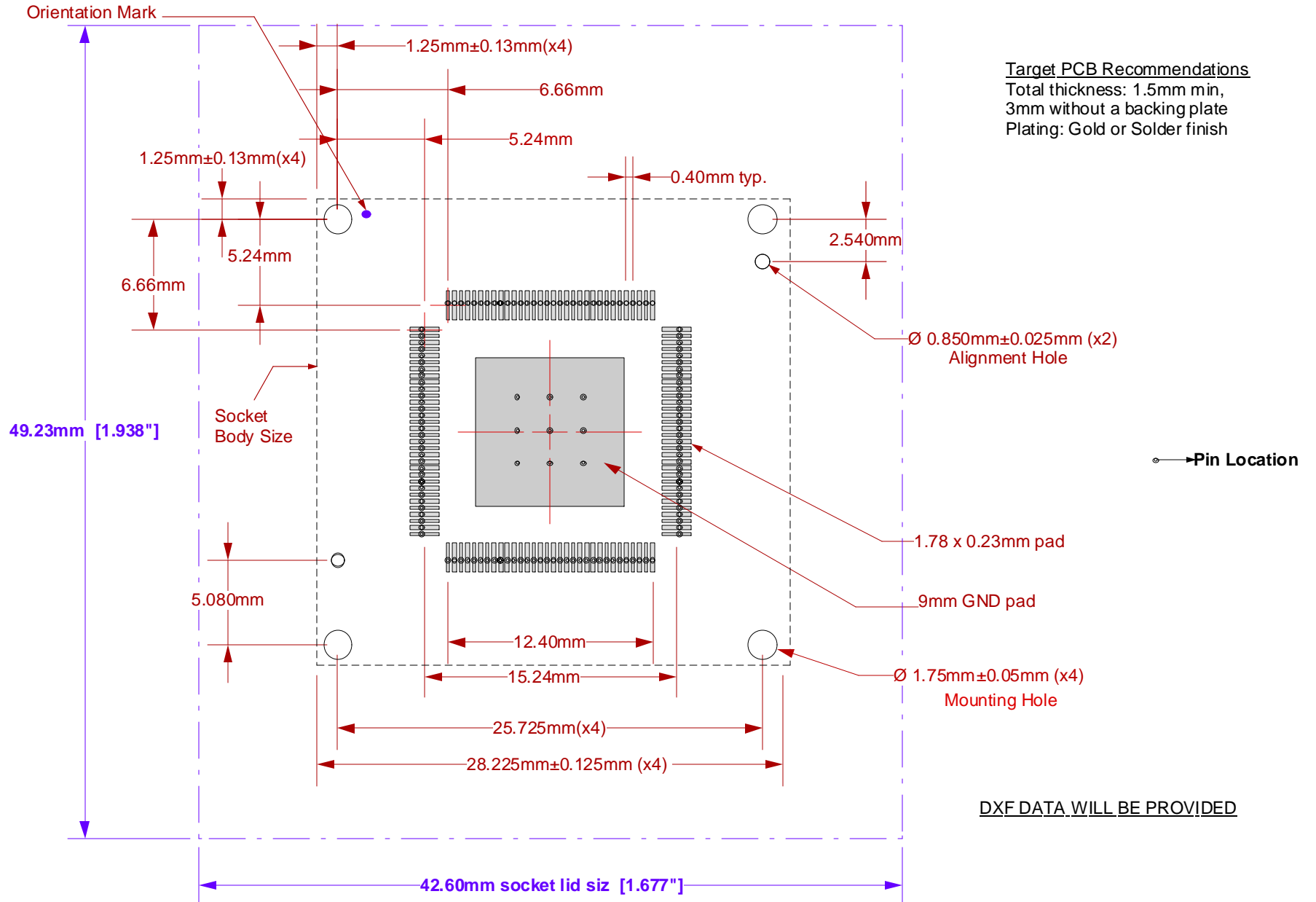

	SS-QFE128SD-02 Drawing © 2010 IRONWOOD ELECTRONICS, INC. Tele: (800) 404-0204 www.ironwoodelectronics.com	Status: Released	Scale:3:1	Rev: A
		Drawing: V. Panavala	Date: 10/14/2010	
		File: SS-QFE128SD-02 Dwg	Modified:	

Recommended PCB Layout
Tolerances: ±0.025mm
[±0.001"] unless stated
otherwise.

Ironwood Package codes accommodated					
Pkg. Code	Pins	Pitch	Body Size	Tip to tip	foot length
QFE128SD	128	0.4mm	14mm x 14mm	16mm x 16mm	0.6mm

TOP VIEW
(Reference Only)

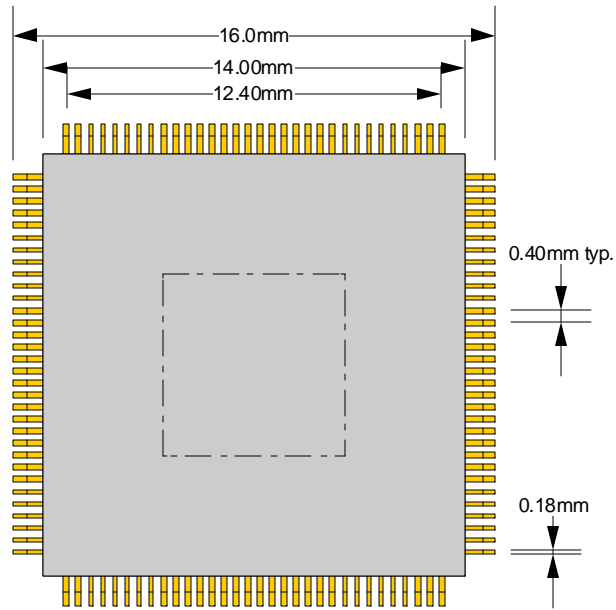

Top View

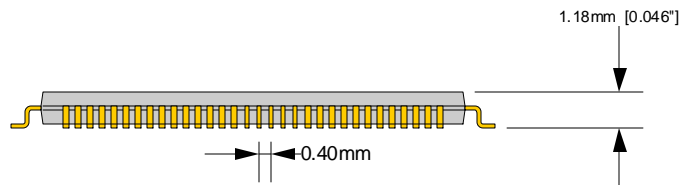

Side View

	SS-QFE128SD-02 Drawing	Status: Released	Scale: N/A	Rev: A
	© 2010 IRONWOOD ELECTRONICS, INC. Tele: (800) 404-0204 www.ironwoodelectronics.com	Drawing: V. Panavala		Date: 10/14/2010
		File: SS-QFE128SD-02 Dwg		Modified:

Top View

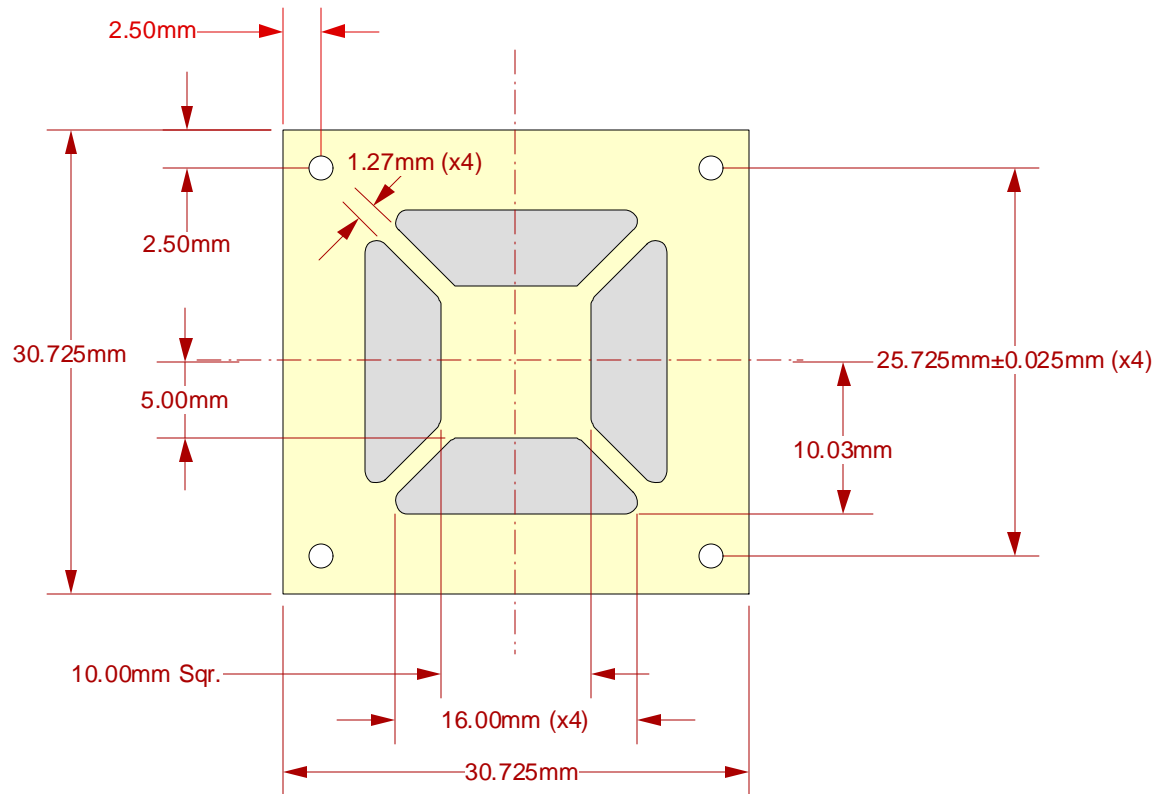

Side View

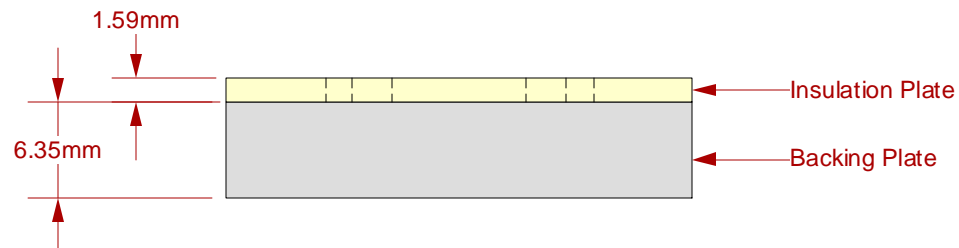

Description: Backing Plate with Insulation Plate

	SS-QFE128SD-02 Drawing	Status: Released	Scale: N/A	Rev: A
	© 2010 IRONWOOD ELECTRONICS, INC. Tele: (800) 404-0204 www.ironwoodelectronics.com	Drawing: V. Panavala		Date: 10/14/2010
		File: SS-QFE128SD-02 Dwg	Modified:	