

SWITCHMODE™ Power Rectifiers

... using the Schottky Barrier principle with a platinum barrier metal. These state-of-the-art devices have the following features:

- Guardring for Stress Protection
- Low Forward Voltage
- 150°C Operating Junction Temperature
- Guaranteed Reverse Avalanche
- Epoxy Meets UL94, VO at 1/8"

Mechanical Characteristics:

- Case: Epoxy, Molded
- Weight: 1.9 grams (approximately)
- Finish: All External Surfaces Corrosion Resistant and Terminal Leads are Readily Solderable
- Lead Temperature for Soldering Purposes: 260°C Max. for 10 Seconds
- Shipped 50 units per plastic tube
- Marking: B2035, B2045

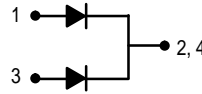

MBR2035CT
MBR2045CT

MBR2045CT is a
Motorola Preferred Device

**SCHOTTKY BARRIER
RECTIFIERS
20 AMPERES
35 and 45 VOLTS**

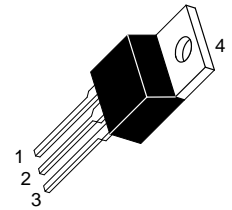

**CASE 221A-06
TO-220AB
PLASTIC**

Rating	Symbol	MBR2035CT	MBR2045CT	Unit
Peak Repetitive Reverse Voltage Working Peak Reverse Voltage DC Blocking Voltage	V_{RRM} V_{RWM} V_R	35	45	Volts
Average Rectified Forward Current (Rated V_R) $T_C = 135^\circ\text{C}$	$I_{F(AV)}$	20	20	Amps
Peak Repetitive Forward Current Per Diode Leg (Rated V_R , Square Wave, 20 kHz) $T_C = 135^\circ\text{C}$	I_{FRM}	20	20	Amps
Nonrepetitive Peak Surge Current (Surge applied at rated load conditions halfwave, single phase, 60 Hz)	I_{FSM}	150	150	Amps
Peak Repetitive Reverse Surge Current (2.0 μs , 1.0 kHz) See Figure 11	I_{RRM}	1.0	1.0	Amp
Operating Junction Temperature	T_J	-65 to +150	-65 to +150	$^\circ\text{C}$
Storage Temperature	T_{stg}	-65 to +175	-65 to +175	$^\circ\text{C}$
Voltage Rate of Change (Rated V_R)	dv/dt	1000	1000	$\text{V}/\mu\text{s}$

THERMAL CHARACTERISTICS

Maximum Thermal Resistance, Junction to Case	$R_{\theta JC}$	2.0	2.0	$^\circ\text{C}/\text{W}$
--	-----------------	-----	-----	---------------------------

ELECTRICAL CHARACTERISTICS

Maximum Instantaneous Forward Voltage (1) ($i_F = 10$ Amps, $T_C = 125^\circ\text{C}$) ($i_F = 20$ Amps, $T_C = 125^\circ\text{C}$) ($i_F = 20$ Amps, $T_C = 25^\circ\text{C}$)	v_F	0.57 0.72 0.84	0.57 0.72 0.84	Volts
Maximum Instantaneous Reverse Current (1) (Rated dc Voltage, $T_C = 125^\circ\text{C}$) (Rated dc Voltage, $T_C = 25^\circ\text{C}$)	i_R	15 0.1	15 0.1	mA



KERSEMI

MBR2035CT MBR2045CT

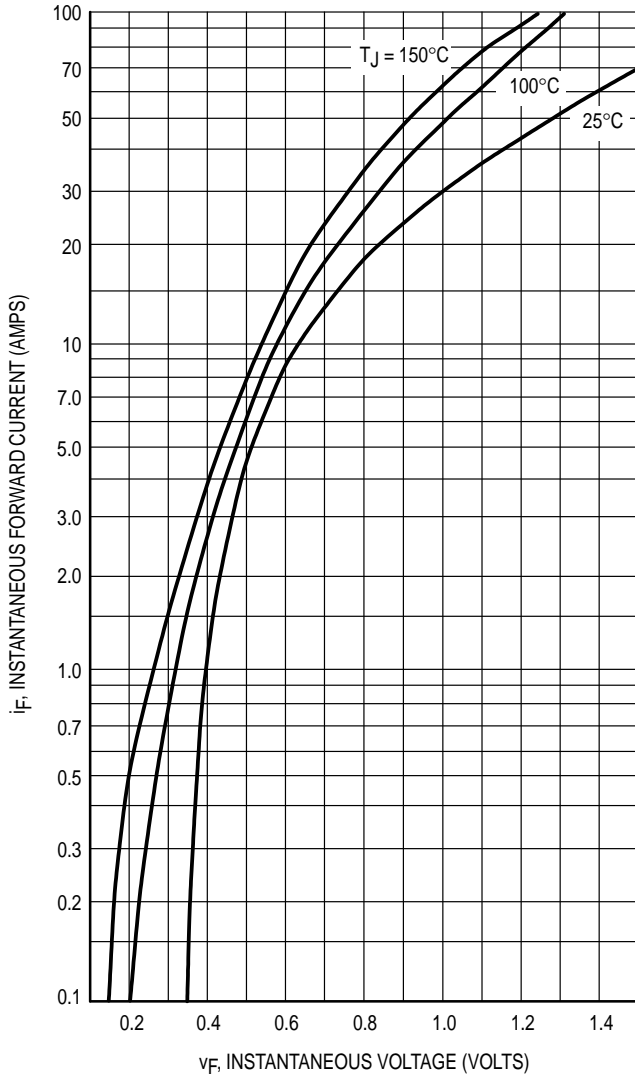

Figure 1. Maximum Forward Voltage

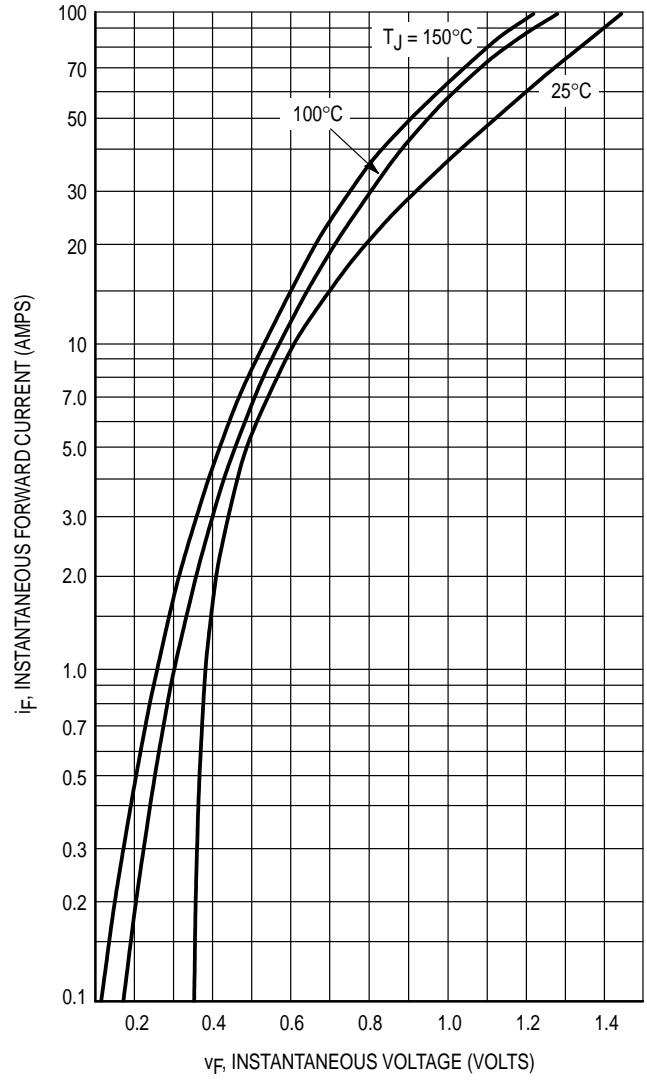

Figure 2. Typical Forward Voltage

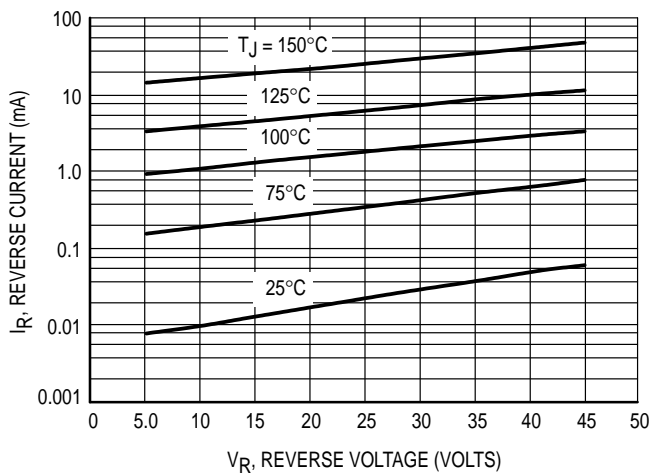

Figure 3. Maximum Reverse Current

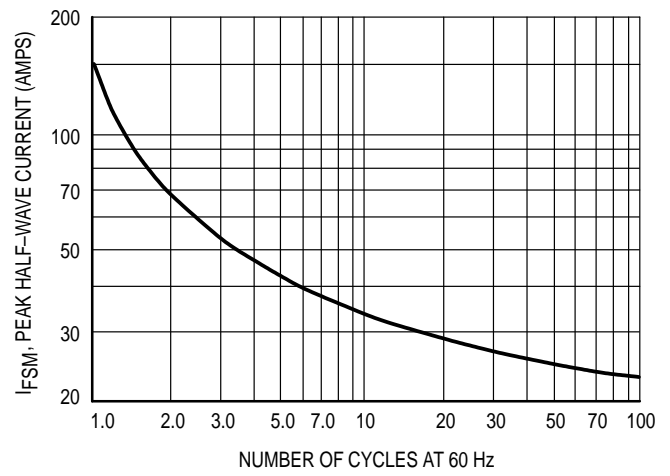

Figure 4. Maximum Surge Capability

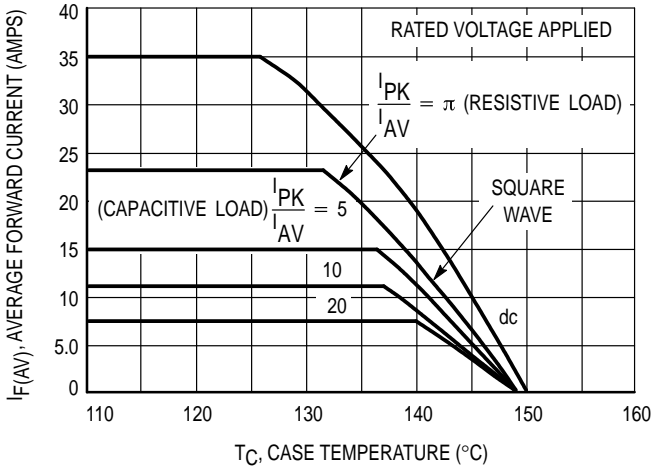

Figure 5. Current Derating, Infinite Heatsink

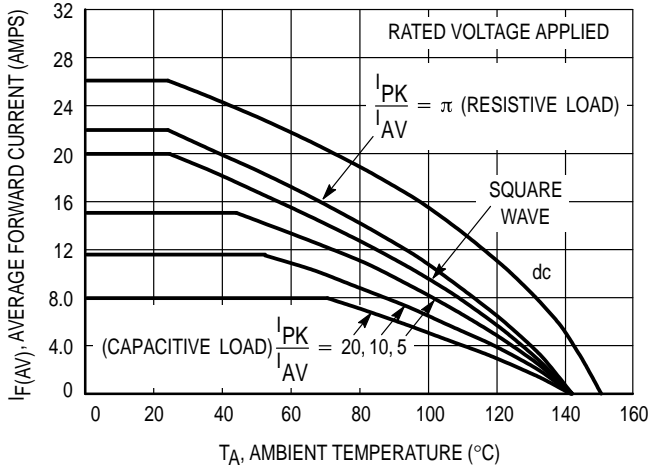

Figure 6. Current Derating, $R_{\theta JA} = 16^{\circ}\text{C/W}$

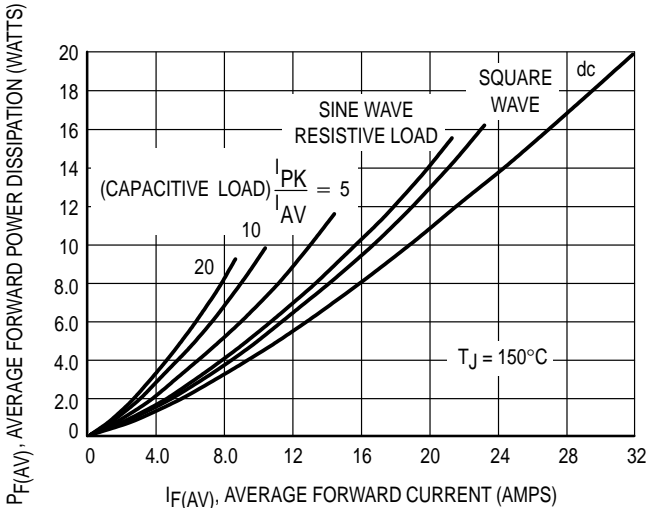

Figure 7. Forward Power Dissipation

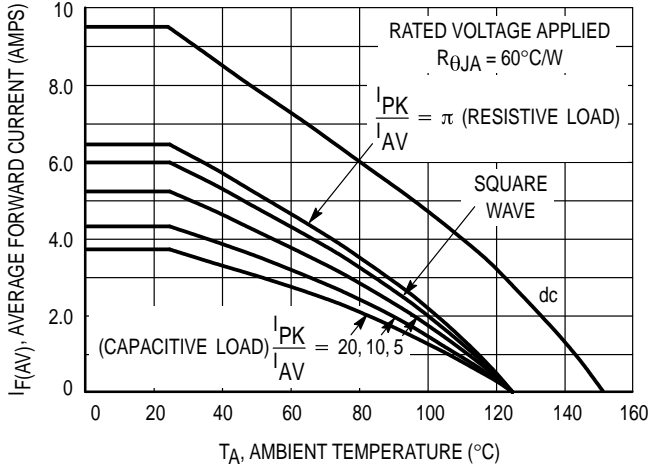

Figure 8. Current Derating, Free Air

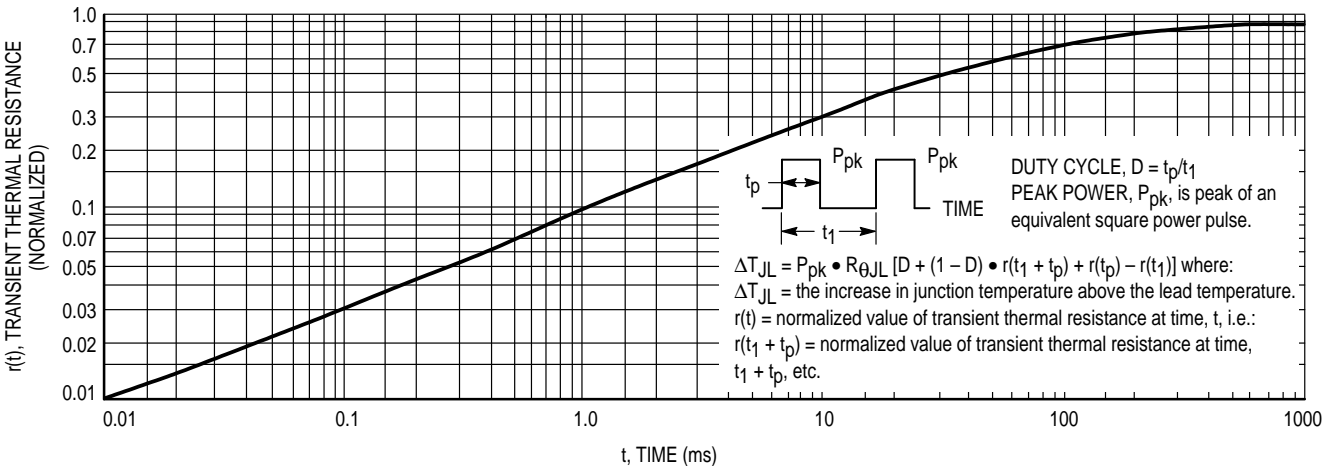

Figure 9. Thermal Response

MBR2035CT MBR2045CT

HIGH FREQUENCY OPERATION

Since current flow in a Schottky rectifier is the result of majority carrier conduction, it is not subject to junction diode forward and reverse recovery transients due to minority carrier injection and stored charge. Satisfactory circuit analysis work may be performed by using a model consisting of an ideal diode in parallel with a variable capacitance. (See Figure 10.)

Rectification efficiency measurements show that operation will be satisfactory up to several megahertz. For example, relative waveform rectification efficiency is approximately 70 percent at 2.0 MHz, e.g., the ratio of dc power to RMS power in the load is 0.28 at this frequency, whereas perfect rectification would yield 0.406 for sine wave inputs. However, in contrast to ordinary junction diodes, the loss in waveform efficiency is not indicative of power loss; it is simply a result of reverse current flow through the diode capacitance, which lowers the dc output voltage.

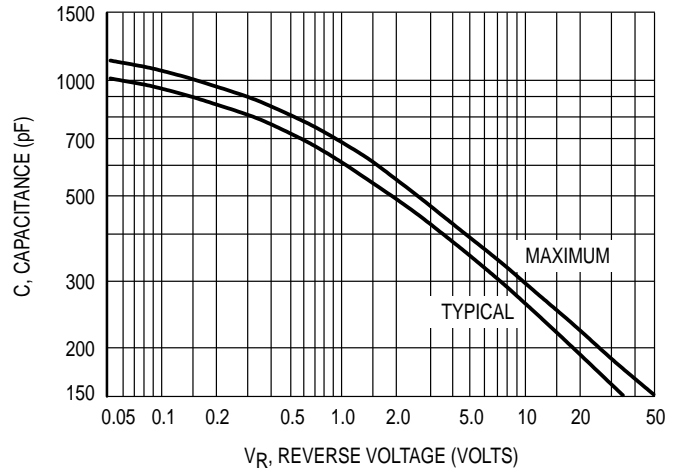

Figure 10. Capacitance

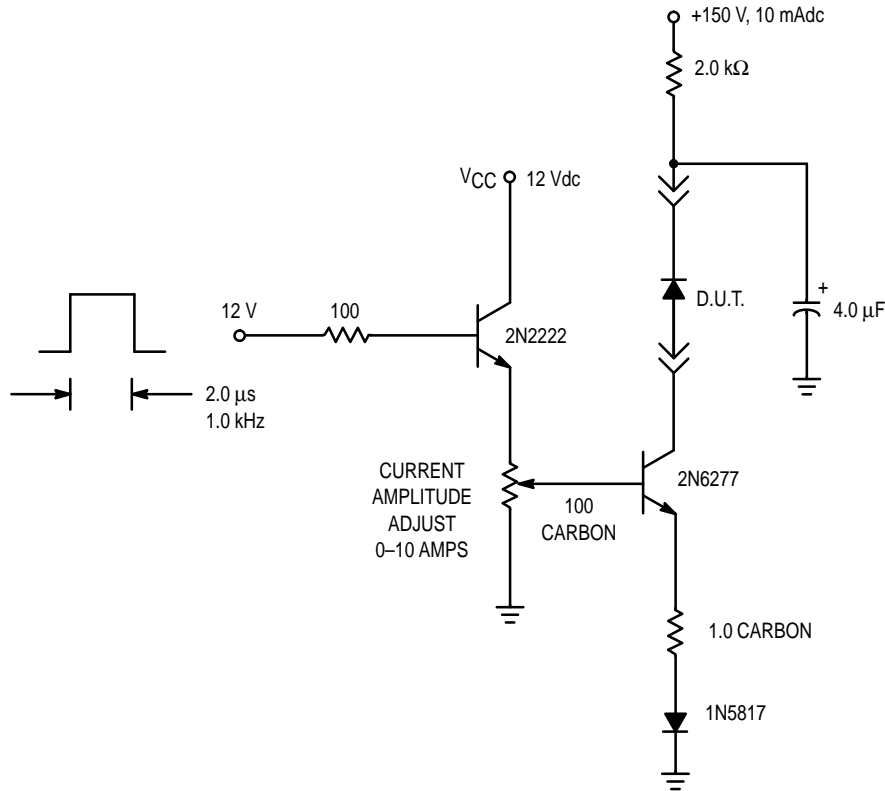
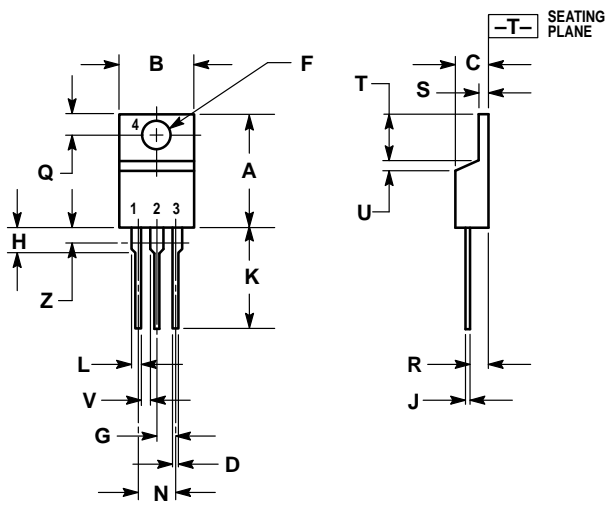

Figure 11. Test Circuit for dv/dt and Reverse Surge Current



- NOTES:
1. DIMENSIONING AND TOLERANCING PER ANSI Y14.5M, 1982.
 2. CONTROLLING DIMENSION: INCH.
 3. DIMENSION Z DEFINES A ZONE WHERE ALL BODY AND LEAD IRREGULARITIES ARE ALLOWED.

DIM	INCHES		MILLIMETERS	
	MIN	MAX	MIN	MAX
A	0.570	0.620	14.48	15.75
B	0.380	0.405	9.66	10.28
C	0.160	0.190	4.07	4.82
D	0.025	0.035	0.64	0.88
F	0.142	0.147	3.61	3.73
G	0.095	0.105	2.42	2.66
H	0.110	0.155	2.80	3.93
J	0.018	0.025	0.46	0.64
K	0.500	0.562	12.70	14.27
L	0.045	0.060	1.15	1.52
N	0.190	0.210	4.83	5.33
Q	0.100	0.120	2.54	3.04
R	0.080	0.110	2.04	2.79
S	0.045	0.055	1.15	1.39
T	0.235	0.255	5.97	6.47
U	0.000	0.050	0.00	1.27
V	0.045	—	1.15	—
Z	—	0.080	—	2.04

CASE 221A-06
(TO-220AB)
ISSUE Y