



Photoelectric sensors
W2 Flat, Photoelectric proximity sensor,
energetic

WT2F-P440



Type > [WT2F-P440](#)
Part No. > [6030586](#)



Illustration may differ

At a glance

- V-optic sensor with fixed sensing ranges of 9 mm or 18 mm for detecting transparent and glossy objects
- Energetic proximity sensor with fixed sensing ranges of 34 or 115 mm
- Rugged housing with metal sleeves for 2 mm fixing screws included with delivery
- 0.5 ms response time
- IP 67 enclosure rating
- Red light

Your benefits

- Variants with V-optics reliably detect transparent and glossy objects, resulting in a low-cost application solution - even for demanding applications
- Smart, optimal design fits into small spaces, providing increased application flexibility
- Sensors with four fixed sensing ranges provides a wide range of application options
- Quick and easy installation since sensors can be mounted directly to the machine



Features

Sensor/detection principle:	Photoelectric proximity sensor, energetic
Dimensions (W x H x D):	14 mm x 19.5 mm x 3.5 mm
Housing design (light emission):	Rectangular
Sensing range max.:	2 mm ... 18 mm ¹⁾
Sensing range:	2 mm ... 18 mm ²⁾
Type of light:	Visible red light
Light source:	LED ³⁾
Wave length:	660 nm
Focus adjustable:	-

^{1) 2)} Object with 90 % reflectance (referred to standard white, DIN 5033) ³⁾ Average service life: 100,000 h at T_U = +25 °C

Mechanics/electronics

Supply voltage:	12 V DC ... 24 V DC ¹⁾
Ripple:	≤ 5 Vpp ²⁾
Output type:	PNP
Switching mode:	Light switching
Output current I _{max.} :	≤ 50 mA
Response time:	≤ 0.5 ms ³⁾

Switching frequency:	1,000 Hz ⁴⁾
Connection type:	Cable with M8 male connector, 4-pin, 200 mm ⁵⁾
Cable material:	PVC
Cable diameter:	2.4 mm
Circuit protection:::	A, C, D ^{6) 7) 8)}
Weight:	20 g
Polarisation filter:	-
Special device:	-
Reverse polarity protection:	✓
Short-circuit protection:	✓
Optics material:	PC
Enclosure rating:	IP 67
Ambient operating temperature:	-20 °C ... +55 °C
Ambient storage temperature:	-40 °C ... +75 °C
Signal voltage PNP HIGH/LOW:	Approx. VS - 1.8 V/0 V
Signal voltage NPN HIGH/LOW:	Approx. VS /< 1.8 V
Housing material:	Plastic, PC

1) +/- 10 % 2) May not exceed or fall below U_v tolerances 3) Signal transit time with resistive load 4) With light/dark ratio 1:1 5) Do not bend below 0 °C 6) A = V_S
connections reverse-polarity protected 7) C = interference suppression 8) D = outputs overcurrent and short-circuit protected

Dimensional drawing

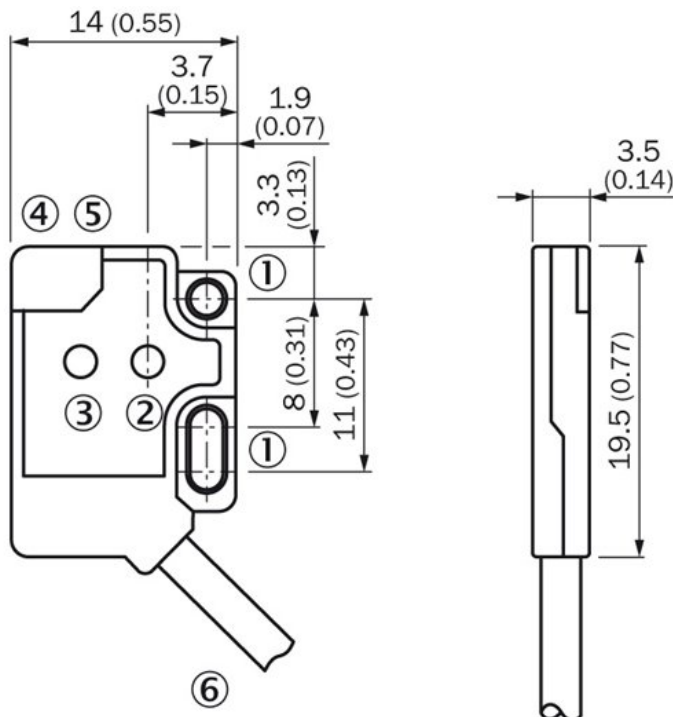

- [1] Mounting holes, Ø 2.1 mm
- [2] Optical axis, sender
- [3] Optical axis, receiver
- [4] LED indicator orange: switching output active
- [5] LED indicator green: strength indicator
- [6] Connection

Connection diagram

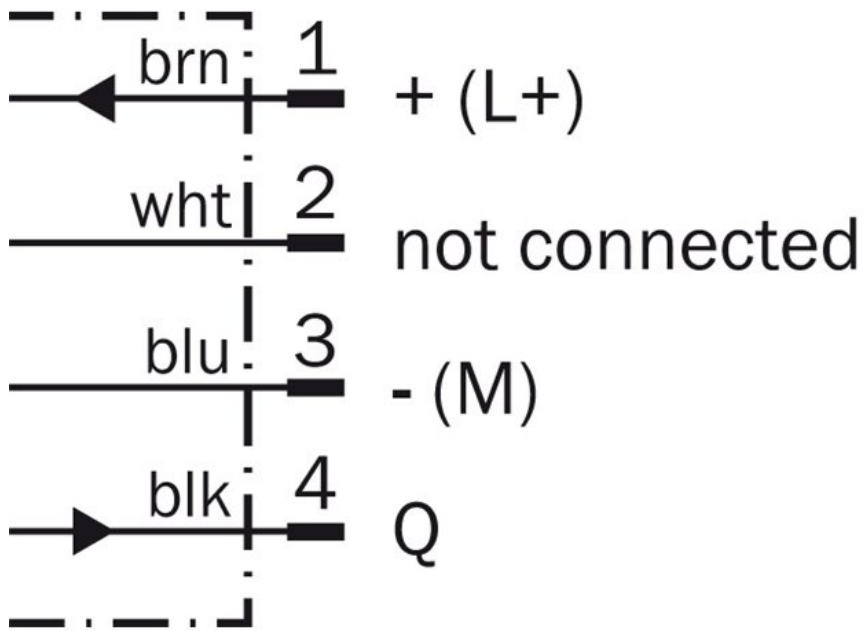

Characteristic curve

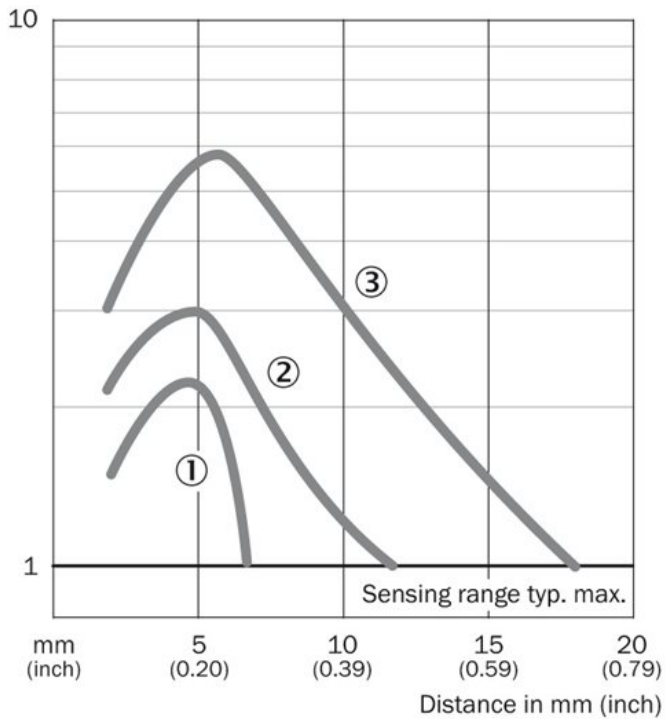

- |1| Sensing range on black, 6 % remission
- |2| Sensing range on gray, 18 % remission
- |3| Sensing range on white, 90 % remission

Sensing range diagram

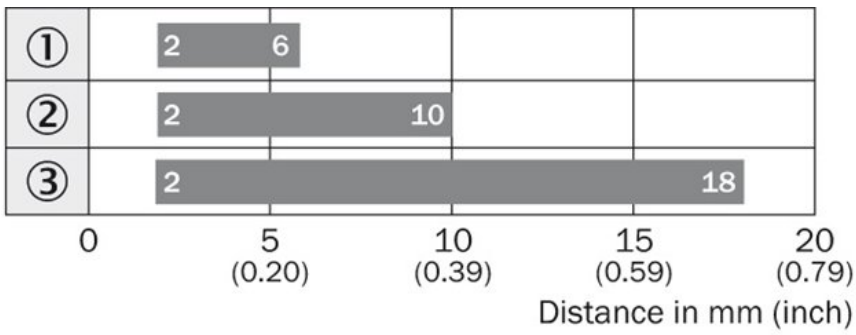

- |1| Sensing range on black, 6 % remission
- |2| Sensing range on gray, 18 % remission
- |3| Sensing range on white, 90 % remission

■ Sensing range

- ① Sensing range on black, 6 % remission
- ② Sensing range on gray, 18 % remission
- ③ Sensing range on white, 90 % remission

Connection type

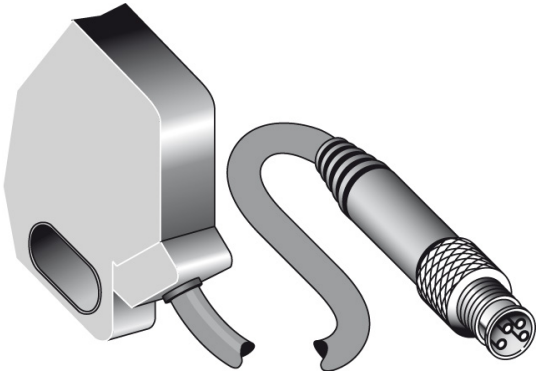

Australia

Phone +61 3 9457 0600
1800 33 48 02 – tollfree
E-Mail sales@sick.com.au

Belgium/Luxembourg

Phone +32 (0)2 466 55 66
E-Mail info@sick.be

Brasil

Phone +55 11 3215-4900
E-Mail marketing@sick.com.br

Canada

Phone +1 905 771 14 44
E-Mail information@sick.com

Česká republika

Phone +420 2 57 91 18 50
E-Mail sick@sick.cz

China

Phone +86 4000 121 000
E-Mail info.china@sick.net.cn
Phone +852-2153 6300
E-Mail ghk@sick.com.hk

Danmark

Phone +45 45 82 64 00
E-Mail sick@sick.dk

Deutschland

Phone +49 211 5301-301
E-Mail info@sick.de

España

Phone +34 93 480 31 00
E-Mail info@sick.es

France

Phone +33 1 64 62 35 00
E-Mail info@sick.fr

Great Britain

Phone +44 (0)1727 831121
E-Mail info@sick.co.uk

India

Phone +91-22-4033 8333
E-Mail info@sick-india.com

Israel

Phone +972-4-6881000
E-Mail info@sick-sensors.com

Italia

Phone +39 02 27 43 41
E-Mail info@sick.it

Japan

Phone +81 (0)3 5309 2112
E-Mail support@sick.jp

Magyarország

Phone +36 1 371 2680
E-Mail office@sick.hu

Nederland

Phone +31 (0)30 229 25 44
E-Mail info@sick.nl

Norge

Phone +47 67 81 50 00
E-Mail sick@sick.no

Österreich

Phone +43 (0)22 36 62 28 8-0
E-Mail office@sick.at

Polska

Phone +48 22 837 40 50
E-Mail info@sick.pl

România

Phone +40 356 171 120
E-Mail office@sick.ro

Russia

Phone +7-495-775-05-30
E-Mail info@sick.ru

Schweiz

Phone +41 41 619 29 39
E-Mail contact@sick.ch

Singapore

Phone +65 6744 3732
E-Mail sales.gsg@sick.com

Slovenija

Phone +386 (0)1-47 69 990
E-Mail office@sick.si

South Africa

Phone +27 11 472 3733
E-Mail info@sickautomation.co.za

South Korea

Phone +82 2 786 6321/4
E-Mail info@sickkorea.net

Suomi

Phone +358-9-25 15 800
E-Mail sick@sick.fi

Sverige

Phone +46 10 110 10 00
E-Mail info@sick.se

Taiwan

Phone +886 2 2375-6288
E-Mail sales@sick.com.tw

Türkiye

Phone +90 (216) 528 50 00
E-Mail info@sick.com.tr

United Arab Emirates

Phone +971 (0) 4 88 65 878
E-Mail info@sick.ae

USA/México

Phone +1(952) 941-6780
1 (800) 325-7425 – tollfree
E-Mail info@sickusa.com

More representatives and agencies
at www.sick.com