

## 1/4" Square, Single-Turn, Through-Hole Sealed Cermet Trimmers

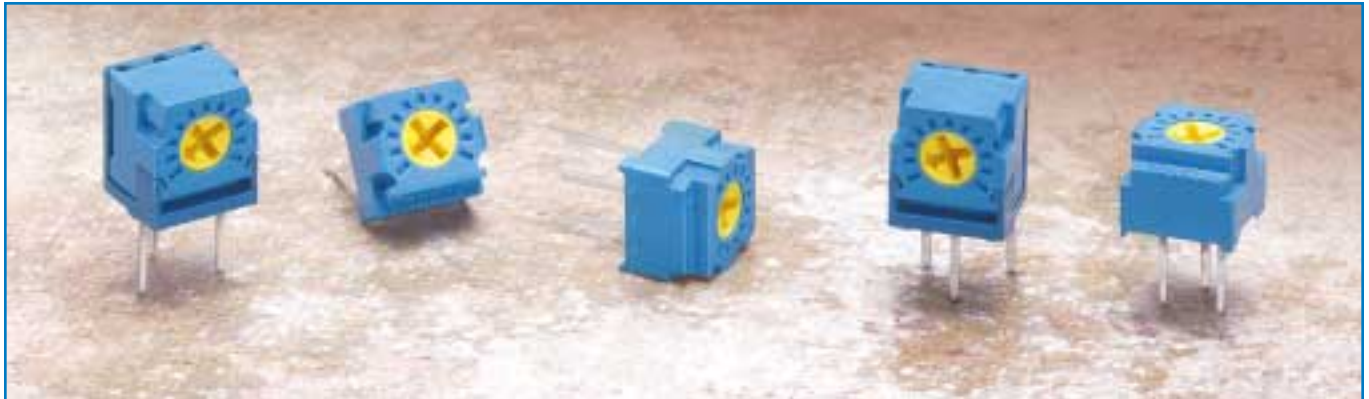

### Features

- 1/4" square, single-turn, through-hole, sealed cermet trimmers
- Top and side adjust styles available
- Larger diameter rotor than GF06 series for easier adjustment
- Precious metal, multi-contact wiper design
- Cross-slot design allows automatic machine adjustment
- Meets UL 94V-0 flammability requirements
- Sealed to withstand wave soldering and immersion cleaning processes
- Taping available, reel or ammo packaging

### Specifications

#### Electrical

<b>Standard Resistance Range</b> . . . . .	10Ω to 5MΩ (standard 1, 2 & 5 sequence)
<b>Resistance Tolerance</b> . . . . .	±10% and ±20%
<b>End Resistance</b> . . . . .	1% or 1Ω, whichever is greater
<b>Resistance Taper</b> . . . . .	Linear
<b>Peak Noise (C.R.V.)</b> . . . . .	1% or 1Ω, whichever is greater
<b>Power Rating</b> . . . . .	0.5 watt at +70°C, 0 watt at +125°C
<b>Maximum Input Voltage</b> . . . . .	250VDC or power rating, whichever is smaller
<b>Temperature Coefficient</b> . . . . .	±100ppm/°C
<b>Insulation Resistance</b> . . . . .	1,000MΩ minimum at 500VDC
<b>Dielectric Strength</b> . . . . .	900VAC, 1 minute
<b>Adjustment Travel</b> . . . . .	210° ±10°

#### Mechanical

<b>Mechanical Travel</b> . . . . .	250° ±10°
<b>Shaft Torque</b> . . . . .	200 gf·cm (2.77 oz·in) max.
<b>Stop Strength</b> . . . . .	500 gf·cm (6.93 oz·in) min.
<b>Flammability of Plastic Materials</b> . . . . .	Meets UL 94V-0
<b>Nominal Weight</b> . . . . .	0.4g (P, P1, W, U) 0.5g (P2, S, S1, X, X1, U1, Y, Y1, V, V1)
<b>Marking</b> . . . . .	Resistance code, date code, model type

#### Environmental

<b>Temperature Range</b> . . . . .	-55°C to +125°C
<b>Low Temperature Operation</b> . . . . .	-55°C, 0.5 watt, 2 hours ΔT/R ≤ ±2%, S.S. ≤ ±2%
<b>High Temperature Exposure</b> . . . . .	+125°C, 250 hours ΔT/R ≤ ±2%, S.S. ≤ ±2%
<b>Load Life</b> . . . . .	+70°C, 0.5 watt, 1,000 hours ΔT/R ≤ ±3%, S.S. ≤ ±2%
<b>Thermal Shock</b> . . . . .	-55°C, +125°C, 30 minutes each, 5 cycles ΔT/R ≤ ±1%, S.S. ≤ ±1%
<b>Shock</b> . . . . .	100G, 6ms, 6 directions, 3 times each ΔT/R ≤ ±1%, S.S. ≤ ±1%
<b>Vibration</b> . . . . .	10-2,000Hz, 1.5mm amplitude, 20G, 12 hours ΔT/R ≤ ±1%, S.S. ≤ ±1%
<b>Humidity</b> . . . . .	+40°C, 90-95% RH, 0.5 watt, 500 hours ΔT/R ≤ ±3%, S.S. ≤ ±2%
<b>Moisture Resistance</b> . . . . .	-10°C to +65°C, 80-98% RH, 0.5 watt, 10 cycles, 240 hours ΔT/R ≤ ±2%
<b>Soldering Heat Resistance</b> . . . . .	350°C, 3 seconds ΔT/R ≤ ±1%
<b>Seal Test</b> . . . . .	+85°C, hot water for 1 minute
<b>Rotational Life</b> . . . . .	100 cycles without discontinuity ΔT/R ≤ ±(2Ω+3%)

ΔT/R = Total Resistance Change; S.S. = Setting Stability (voltage ratio)

For GF063 models available with a knob, refer to the GF063-K Series on page 68.

**GF063P Cross-Slot, Top Adjust, P Terminal Style**

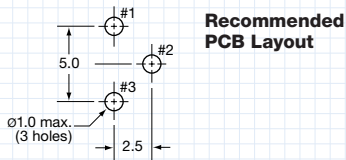
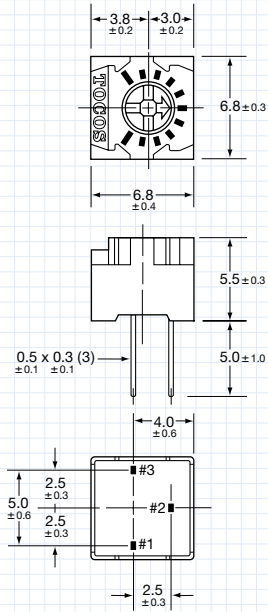

**GF063P1 Cross-Slot, Top Adjust, P1, P1-3\* & P1-LM\* Terminal Styles**

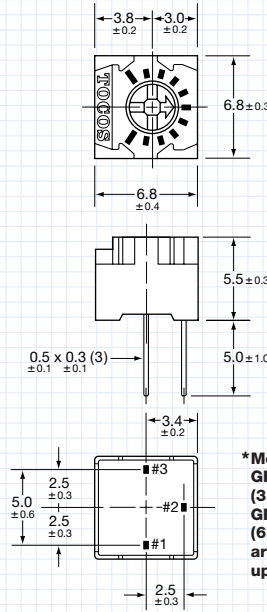

\*Models GF063P1-3 (3mm leads) and GF063P1-LM (6.5mm leads) are available upon request.

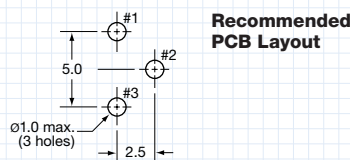

**GF063P2 Cross-Slot, Top Adjust, P2 Terminal Style**

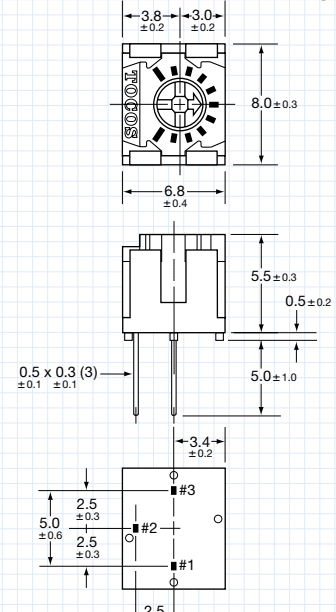

Unit: mm

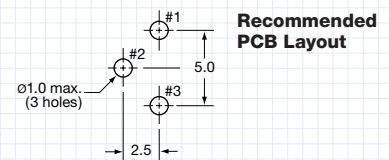

**GF063W Cross-Slot, Top Adjust, W Terminal Style**

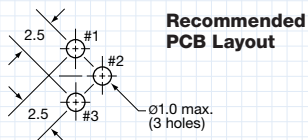
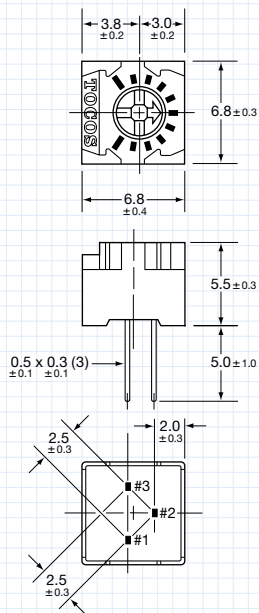

**GF063U Cross-Slot, Top Adjust, U & U-LL\* Terminal Styles**

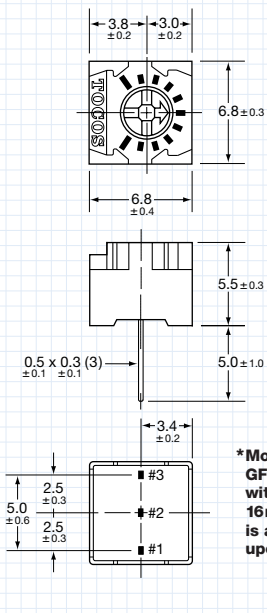

\*Model GF063U-LL with longer 16mm leads is available upon request.

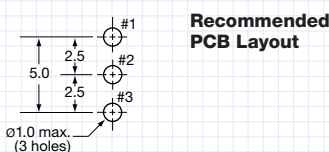

**GF063U1 Cross-Slot, Top Adjust, U1 Terminal Style**

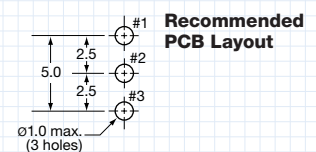
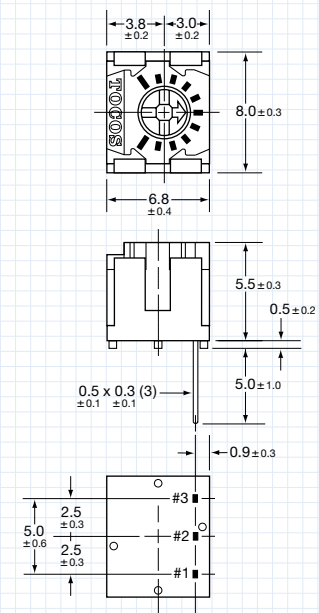

**GF063Y**  
Y Terminal Style, Cross-Slot, Top Adjust

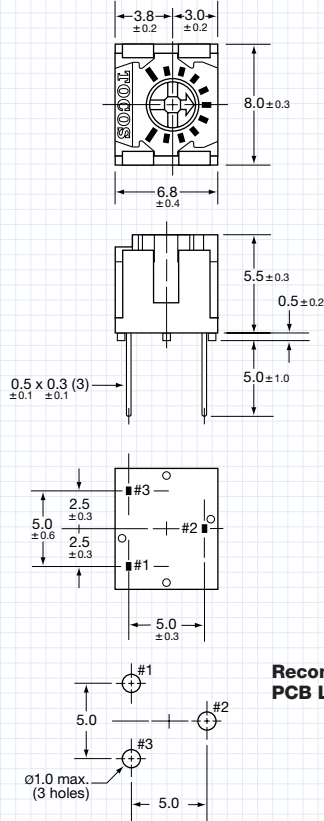

**Recommended PCB Layout**

**GF063Y1**  
Y1 Terminal Style, Cross-Slot, Top Adjust

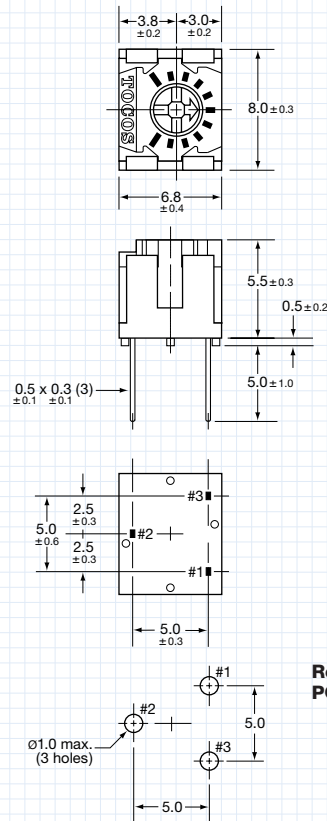

**Recommended PCB Layout**

**GF063S**  
S Terminal Style, Cross-Slot, Side Adjust

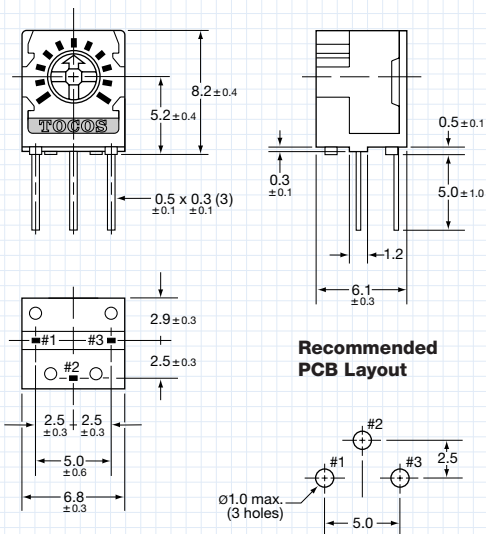

**Recommended PCB Layout**

**GF063S1**  
S1 Terminal Style, Cross-Slot, Side Adjust

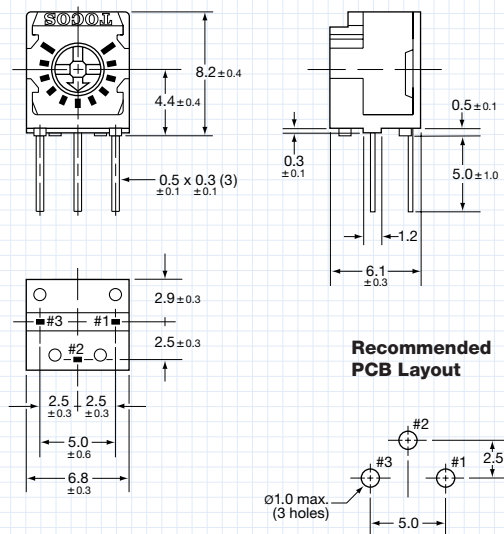

**Recommended PCB Layout**

**GF063X**

X Terminal Style, Cross-Slot, Side Adjust

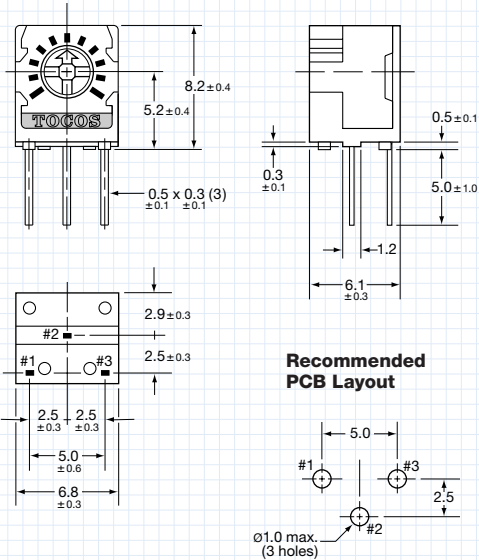

**GF063X1**

X1 Terminal Style, Cross-Slot, Side Adjust

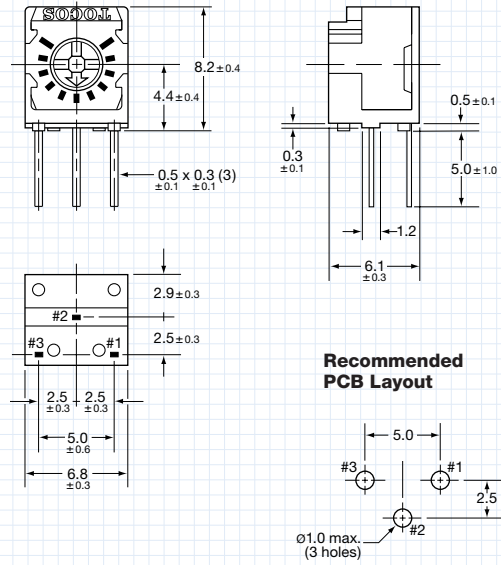

**GF063V**

V & V-3\* Terminal Styles, Cross-Slot, Side Adjust

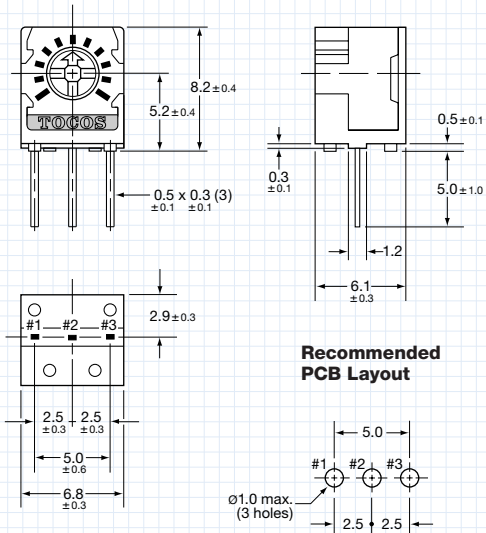

**GF063V1**

V1 Terminal Style, Cross-Slot, Side Adjust

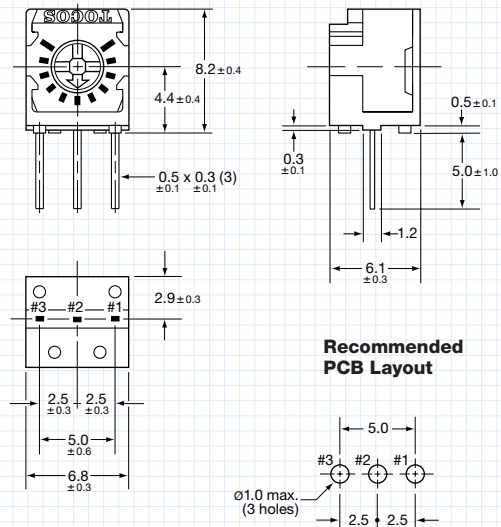

\*Upon request GF063V-3 is available with shorter 3mm leads.

**Rotor and Slot Dimensions**

**All GF063 Models**

Unit: mm

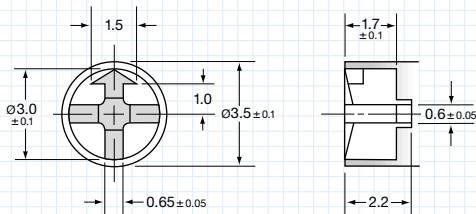

**Electrical Schematic**

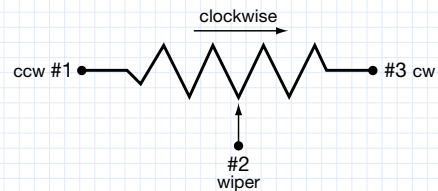

**Tape Dimensions**

Conforms to EIA-468-B and JIS-C-0805

**PT, PT2, P1T, P1T2**

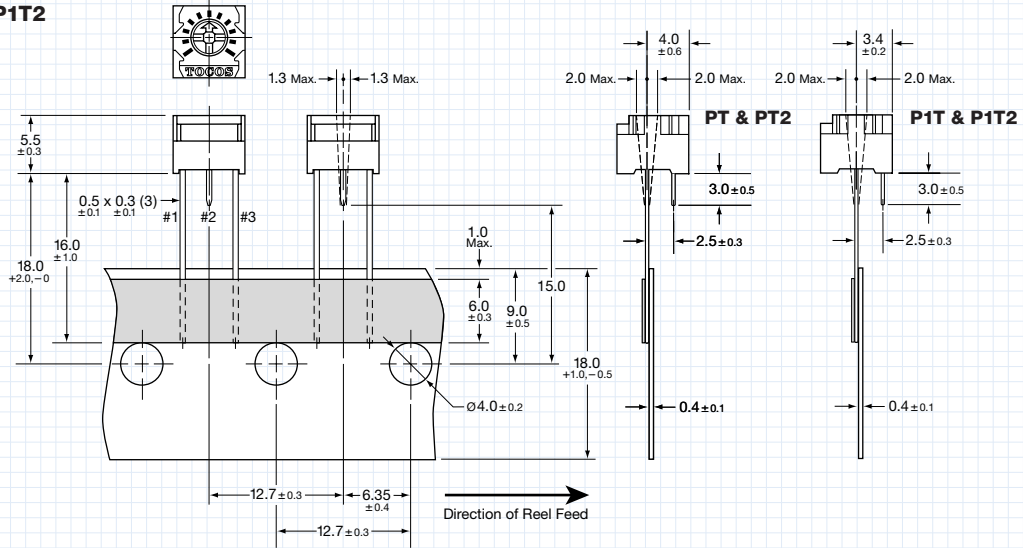

**UT, UT2**

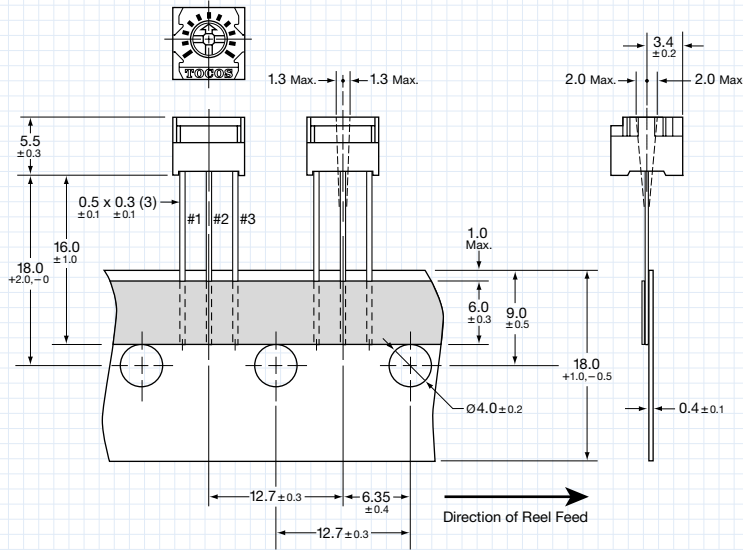

**ST, ST2, XT2 (XT not available)**

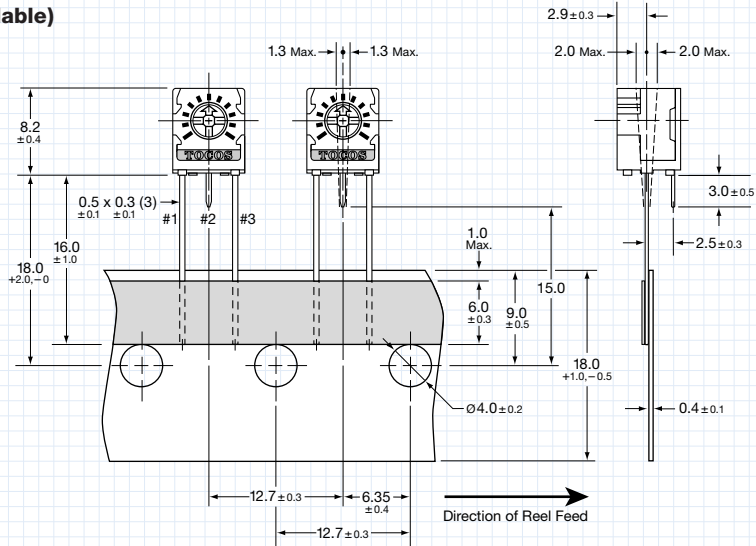

**Tape Dimensions**

Conforms to EIA-468-B and JIS-C-0805

**S1T, S1T2**

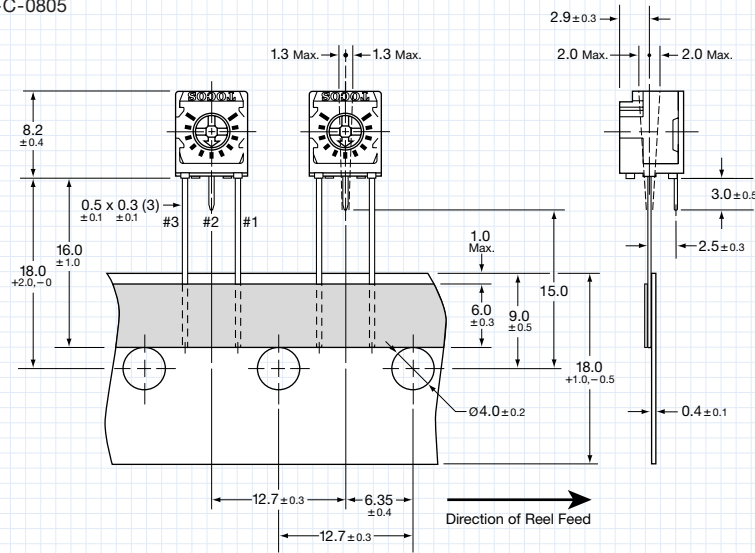

**X1T2 (X1T not available)**

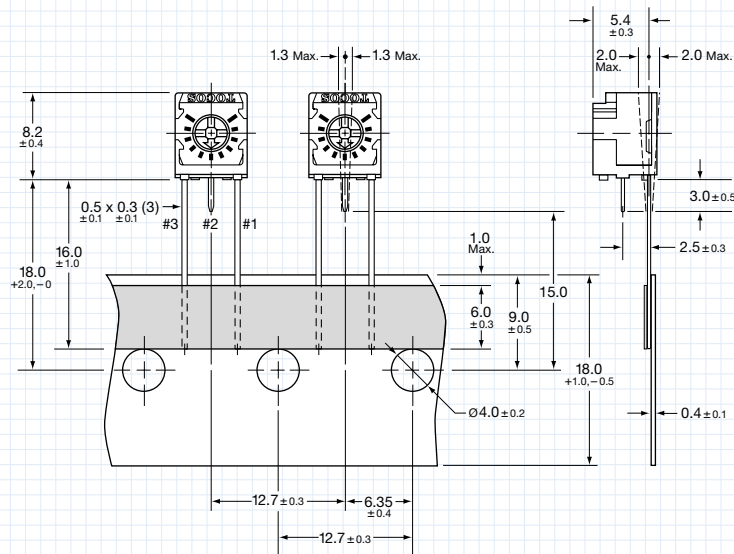

**VT, VT2**

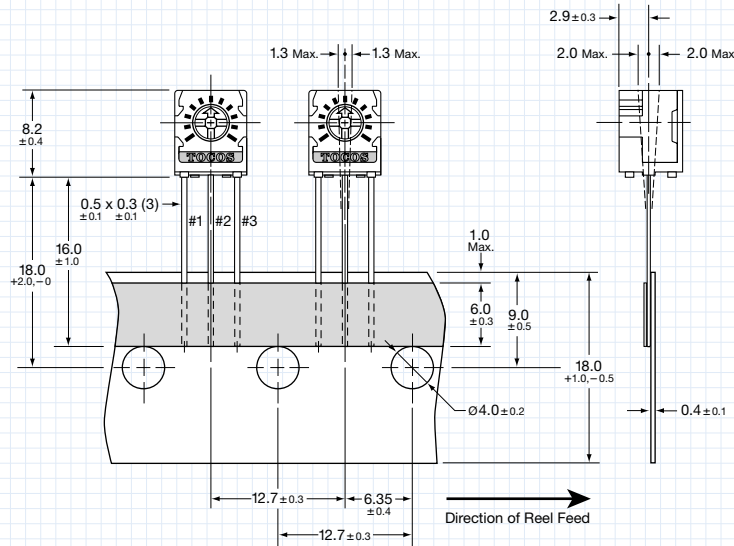

**Tape Dimensions**

Conforms to EIA-468-B and JIS-C-0805

**V1T, V1T2**

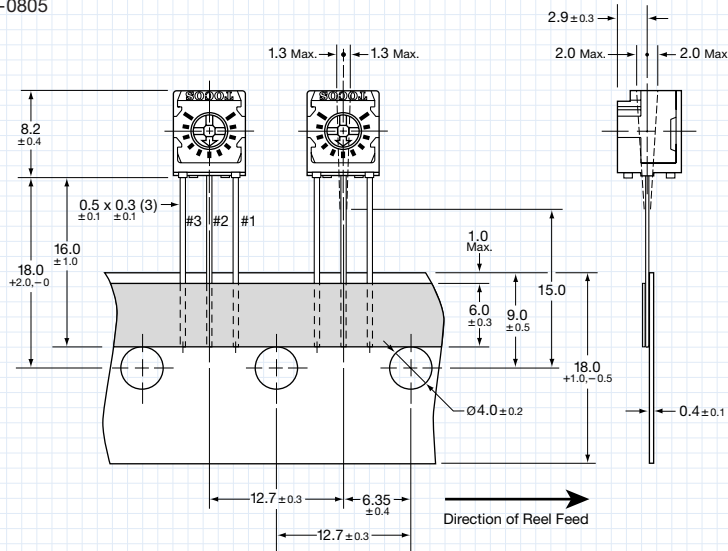

**Reel Dimensions**

Conforms to EIA-468-B and JIS-C-0805

**PT, P1T, UT, ST, S1T, VT, V1T**

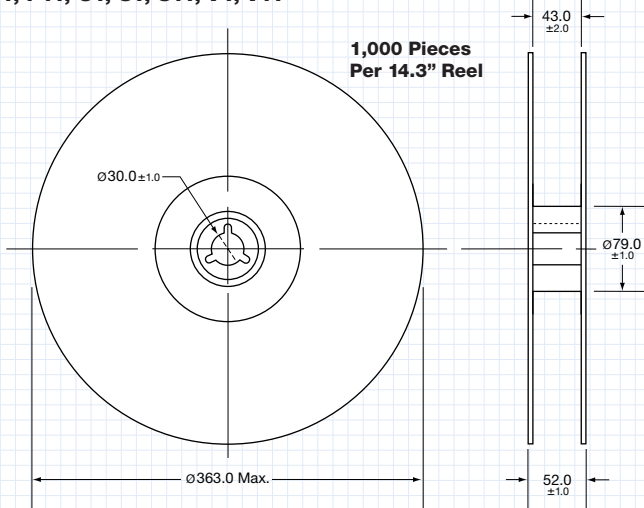

**Ammo Box Dimensions**

Conforms to EIA-468-B and JIS-C-0805

**PT2, P1T2, UT2, ST2, S1T2, XT2, X1T2, VT2, V1T2**

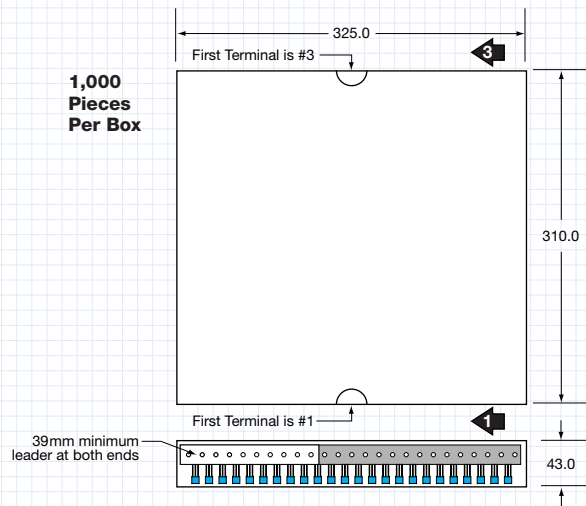

**Part Numbering System**

**GF063 P1 T2 B 102 K**

- Resistance Tolerance: K = ±10%; M = ±20%
- Resistance Code: Expressed in ohms. A three digit code where the first two digits are significant figures, and the third digit indicates the number of zeros that follow these figures (i.e., 100 = 10Ω; 101 = 100Ω; 102 = 1,000Ω; 105 = 1,000,000Ω).
- Resistance Taper: B = Linear.
- Packaging: T = Tape & Reel; T2 = Tape & Ammo Box; Blank = Bulk.
- Terminal Style: P, P1, P2, W, U, U1, Y, Y1 = 3-Lead Configurations, Top Adjust.  
S, S1, X, X1, V, V1 = 3-Lead Configurations, Side Adjust.  
P1-3 = Special Option, 3mm Leads, Top Adjust.  
P1-LM = Special Option, 6.5mm Leads, Top Adjust.  
U-LL = Special Option, 16mm Leads, Top Adjust.  
V-3 = Special Option, 3mm Leads, Side Adjust.
- TOCOS Series Name.



Nominal Resistance		Resistance Tolerance: K = ±10% (see footnote for M = ±20%)			Potentiometer Styles
Value (Ω)	Code	Catalog No.* Tape & Reel	Catalog No.* Tape & Ammo Box	Catalog No.* Bulk	

**GF063P Through-Hole, P Terminal Style, Cross-Slot, Top Adjust**

10	100	GF063PT B 100 K	GF063PT2 B 100 K	GF063P B 100 K
20	200	GF063PT B 200 K	GF063PT2 B 200 K	GF063P B 200 K
50	500	GF063PT B 500 K	GF063PT2 B 500 K	GF063P B 500 K
100	101	GF063PT B 101 K	GF063PT2 B 101 K	GF063P B 101 K
200	201	GF063PT B 201 K	GF063PT2 B 201 K	GF063P B 201 K
500	501	GF063PT B 501 K	GF063PT2 B 501 K	GF063P B 501 K
1,000	102	GF063PT B 102 K	GF063PT2 B 102 K	GF063P B 102 K
2,000	202	GF063PT B 202 K	GF063PT2 B 202 K	GF063P B 202 K
5,000	502	GF063PT B 502 K	GF063PT2 B 502 K	GF063P B 502 K
10,000	103	GF063PT B 103 K	GF063PT2 B 103 K	GF063P B 103 K
20,000	203	GF063PT B 203 K	GF063PT2 B 203 K	GF063P B 203 K
50,000	503	GF063PT B 503 K	GF063PT2 B 503 K	GF063P B 503 K
100,000	104	GF063PT B 104 K	GF063PT2 B 104 K	GF063P B 104 K
200,000	204	GF063PT B 204 K	GF063PT2 B 204 K	GF063P B 204 K
500,000	504	GF063PT B 504 K	GF063PT2 B 504 K	GF063P B 504 K
1,000,000	105	GF063PT B 105 K	GF063PT2 B 105 K	GF063P B 105 K
2,000,000	205	GF063PT B 205 K	GF063PT2 B 205 K	GF063P B 205 K
5,000,000	505	GF063PT B 505 K	GF063PT2 B 505 K	GF063P B 505 K



**GF063P**

**GF063P1 Through-Hole, P1 Terminal Style, Cross-Slot, Top Adjust**

10	100	GF063P1T B 100 K	GF063P1T2 B 100 K	GF063P1 B 100 K
20	200	GF063P1T B 200 K	GF063P1T2 B 200 K	GF063P1 B 200 K
50	500	GF063P1T B 500 K	GF063P1T2 B 500 K	GF063P1 B 500 K
100	101	GF063P1T B 101 K	GF063P1T2 B 101 K	GF063P1 B 101 K
200	201	GF063P1T B 201 K	GF063P1T2 B 201 K	GF063P1 B 201 K
500	501	GF063P1T B 501 K	GF063P1T2 B 501 K	GF063P1 B 501 K
1,000	102	GF063P1T B 102 K	GF063P1T2 B 102 K	GF063P1 B 102 K
2,000	202	GF063P1T B 202 K	GF063P1T2 B 202 K	GF063P1 B 202 K
5,000	502	GF063P1T B 502 K	GF063P1T2 B 502 K	GF063P1 B 502 K
10,000	103	GF063P1T B 103 K	GF063P1T2 B 103 K	GF063P1 B 103 K
20,000	203	GF063P1T B 203 K	GF063P1T2 B 203 K	GF063P1 B 203 K
50,000	503	GF063P1T B 503 K	GF063P1T2 B 503 K	GF063P1 B 503 K
100,000	104	GF063P1T B 104 K	GF063P1T2 B 104 K	GF063P1 B 104 K
200,000	204	GF063P1T B 204 K	GF063P1T2 B 204 K	GF063P1 B 204 K
500,000	504	GF063P1T B 504 K	GF063P1T2 B 504 K	GF063P1 B 504 K
1,000,000	105	GF063P1T B 105 K	GF063P1T2 B 105 K	GF063P1 B 105 K
2,000,000	205	GF063P1T B 205 K	GF063P1T2 B 205 K	GF063P1 B 205 K
5,000,000	505	GF063P1T B 505 K	GF063P1T2 B 505 K	GF063P1 B 505 K



**GF063P1**

**GF063P2 Through-Hole, P2 Terminal Style, Cross-Slot, Top Adjust**

10	100	—	—	GF063P2 B 100 K
20	200	—	—	GF063P2 B 200 K
50	500	—	—	GF063P2 B 500 K
100	101	—	—	GF063P2 B 101 K
200	201	—	—	GF063P2 B 201 K
500	501	—	—	GF063P2 B 501 K
1,000	102	—	—	GF063P2 B 102 K
2,000	202	—	—	GF063P2 B 202 K
5,000	502	—	—	GF063P2 B 502 K
10,000	103	—	—	GF063P2 B 103 K
20,000	203	—	—	GF063P2 B 203 K
50,000	503	—	—	GF063P2 B 503 K
100,000	104	—	—	GF063P2 B 104 K
200,000	204	—	—	GF063P2 B 204 K
500,000	504	—	—	GF063P2 B 504 K
1,000,000	105	—	—	GF063P2 B 105 K
2,000,000	205	—	—	GF063P2 B 205 K
5,000,000	505	—	—	GF063P2 B 505 K



**GF063P2**

\*Substitute code letter M in place of K at end of catalog part number for ±20% resistance tolerance.



Nominal Resistance		Resistance Tolerance: K = ±10% (see footnote for M = ±20%)			Potentiometer Styles
Value (Ω)	Code	Catalog No.* Tape & Reel	Catalog No.* Tape & Ammo Box	Catalog No.* Bulk	

**GF063W Through-Hole, W Terminal Style, Cross-Slot, Top Adjust**

10	100	—	—	GF063W B 100 K
20	200	—	—	GF063W B 200 K
50	500	—	—	GF063W B 500 K
100	101	—	—	GF063W B 101 K
200	201	—	—	GF063W B 201 K
500	501	—	—	GF063W B 501 K
1,000	102	—	—	GF063W B 102 K
2,000	202	—	—	GF063W B 202 K
5,000	502	—	—	GF063W B 502 K
10,000	103	—	—	GF063W B 103 K
20,000	203	—	—	GF063W B 203 K
50,000	503	—	—	GF063W B 503 K
100,000	104	—	—	GF063W B 104 K
200,000	204	—	—	GF063W B 204 K
500,000	504	—	—	GF063W B 504 K
1,000,000	105	—	—	GF063W B 105 K
2,000,000	205	—	—	GF063W B 205 K
5,000,000	505	—	—	GF063W B 505 K



**GF063W**

**GF063U Through-Hole, U Terminal Style, Cross-Slot, Top Adjust**

10	100	GF063UT B 100 K	GF063UT2 B 100 K	GF063U B 100 K
20	200	GF063UT B 200 K	GF063UT2 B 200 K	GF063U B 200 K
50	500	GF063UT B 500 K	GF063UT2 B 500 K	GF063U B 500 K
100	101	GF063UT B 101 K	GF063UT2 B 101 K	GF063U B 101 K
200	201	GF063UT B 201 K	GF063UT2 B 201 K	GF063U B 201 K
500	501	GF063UT B 501 K	GF063UT2 B 501 K	GF063U B 501 K
1,000	102	GF063UT B 102 K	GF063UT2 B 102 K	GF063U B 102 K
2,000	202	GF063UT B 202 K	GF063UT2 B 202 K	GF063U B 202 K
5,000	502	GF063UT B 502 K	GF063UT2 B 502 K	GF063U B 502 K
10,000	103	GF063UT B 103 K	GF063UT2 B 103 K	GF063U B 103 K
20,000	203	GF063UT B 203 K	GF063UT2 B 203 K	GF063U B 203 K
50,000	503	GF063UT B 503 K	GF063UT2 B 503 K	GF063U B 503 K
100,000	104	GF063UT B 104 K	GF063UT2 B 104 K	GF063U B 104 K
200,000	204	GF063UT B 204 K	GF063UT2 B 204 K	GF063U B 204 K
500,000	504	GF063UT B 504 K	GF063UT2 B 504 K	GF063U B 504 K
1,000,000	105	GF063UT B 105 K	GF063UT2 B 105 K	GF063U B 105 K
2,000,000	205	GF063UT B 205 K	GF063UT2 B 205 K	GF063U B 205 K
5,000,000	505	GF063UT B 505 K	GF063UT2 B 505 K	GF063U B 505 K



**GF063U**

**GF063U1 Through-Hole, U1 Terminal Style, Cross-Slot, Top Adjust**

10	100	—	—	GF063U1 B 100 K
20	200	—	—	GF063U1 B 200 K
50	500	—	—	GF063U1 B 500 K
100	101	—	—	GF063U1 B 101 K
200	201	—	—	GF063U1 B 201 K
500	501	—	—	GF063U1 B 501 K
1,000	102	—	—	GF063U1 B 102 K
2,000	202	—	—	GF063U1 B 202 K
5,000	502	—	—	GF063U1 B 502 K
10,000	103	—	—	GF063U1 B 103 K
20,000	203	—	—	GF063U1 B 203 K
50,000	503	—	—	GF063U1 B 503 K
100,000	104	—	—	GF063U1 B 104 K
200,000	204	—	—	GF063U1 B 204 K
500,000	504	—	—	GF063U1 B 504 K
1,000,000	105	—	—	GF063U1 B 105 K
2,000,000	205	—	—	GF063U1 B 205 K
5,000,000	505	—	—	GF063U1 B 505 K



**GF063U1**

\*Substitute code letter M in place of K at end of catalog part number for ±20% resistance tolerance.

Nominal Resistance		Resistance Tolerance: K = ±10% (see footnote for M = ±20%)			Potentiometer Styles
Value (Ω)	Code	Catalog No.* Tape & Reel	Catalog No.* Tape & Ammo Box	Catalog No.* Bulk	

**GF063Y Through-Hole, Y Terminal Style, Cross-Slot, Top Adjust**

10	100	—	—	GF063Y B 100 K
20	200	—	—	GF063Y B 200 K
50	500	—	—	GF063Y B 500 K
100	101	—	—	GF063Y B 101 K
200	201	—	—	GF063Y B 201 K
500	501	—	—	GF063Y B 501 K
1,000	102	—	—	GF063Y B 102 K
2,000	202	—	—	GF063Y B 202 K
5,000	502	—	—	GF063Y B 502 K
10,000	103	—	—	GF063Y B 103 K
20,000	203	—	—	GF063Y B 203 K
50,000	503	—	—	GF063Y B 503 K
100,000	104	—	—	GF063Y B 104 K
200,000	204	—	—	GF063Y B 204 K
500,000	504	—	—	GF063Y B 504 K
1,000,000	105	—	—	GF063Y B 105 K
2,000,000	205	—	—	GF063Y B 205 K
5,000,000	505	—	—	GF063Y B 505 K



**GF063Y**

**GF063Y1 Through-Hole, Y1 Terminal Style, Cross-Slot, Top Adjust**

10	100	—	—	GF063Y1 B 100 K
20	200	—	—	GF063Y1 B 200 K
50	500	—	—	GF063Y1 B 500 K
100	101	—	—	GF063Y1 B 101 K
200	201	—	—	GF063Y1 B 201 K
500	501	—	—	GF063Y1 B 501 K
1,000	102	—	—	GF063Y1 B 102 K
2,000	202	—	—	GF063Y1 B 202 K
5,000	502	—	—	GF063Y1 B 502 K
10,000	103	—	—	GF063Y1 B 103 K
20,000	203	—	—	GF063Y1 B 203 K
50,000	503	—	—	GF063Y1 B 503 K
100,000	104	—	—	GF063Y1 B 104 K
200,000	204	—	—	GF063Y1 B 204 K
500,000	504	—	—	GF063Y1 B 504 K
1,000,000	105	—	—	GF063Y1 B 105 K
2,000,000	205	—	—	GF063Y1 B 205 K
5,000,000	505	—	—	GF063Y1 B 505 K



**GF063Y1**

**GF063S Through-Hole, S Terminal Style, Cross-Slot, Side Adjust**

10	100	GF063ST B 100 K	GF063ST2 B 100 K	GF063S B 100 K
20	200	GF063ST B 200 K	GF063ST2 B 200 K	GF063S B 200 K
50	500	GF063ST B 500 K	GF063ST2 B 500 K	GF063S B 500 K
100	101	GF063ST B 101 K	GF063ST2 B 101 K	GF063S B 101 K
200	201	GF063ST B 201 K	GF063ST2 B 201 K	GF063S B 201 K
500	501	GF063ST B 501 K	GF063ST2 B 501 K	GF063S B 501 K
1,000	102	GF063ST B 102 K	GF063ST2 B 102 K	GF063S B 102 K
2,000	202	GF063ST B 202 K	GF063ST2 B 202 K	GF063S B 202 K
5,000	502	GF063ST B 502 K	GF063ST2 B 502 K	GF063S B 502 K
10,000	103	GF063ST B 103 K	GF063ST2 B 103 K	GF063S B 103 K
20,000	203	GF063ST B 203 K	GF063ST2 B 203 K	GF063S B 203 K
50,000	503	GF063ST B 503 K	GF063ST2 B 503 K	GF063S B 503 K
100,000	104	GF063ST B 104 K	GF063ST2 B 104 K	GF063S B 104 K
200,000	204	GF063ST B 204 K	GF063ST2 B 204 K	GF063S B 204 K
500,000	504	GF063ST B 504 K	GF063ST2 B 504 K	GF063S B 504 K
1,000,000	105	GF063ST B 105 K	GF063ST2 B 105 K	GF063S B 105 K
2,000,000	205	GF063ST B 205 K	GF063ST2 B 205 K	GF063S B 205 K
5,000,000	505	GF063ST B 505 K	GF063ST2 B 505 K	GF063S B 505 K



**GF063S**

\*Substitute code letter M in place of K at end of catalog part number for ±20% resistance tolerance.

Nominal Resistance		Resistance Tolerance: K = ±10% (see footnote for M = ±20%)			Potentiometer Styles
Value (Ω)	Code	Catalog No.* Tape & Reel	Catalog No.* Tape & Ammo Box	Catalog No.* Bulk	

**GF063S1 Through-Hole, S1 Terminal Style, Cross-Slot, Side Adjust**

10	100	GF063S1T B 100 K	GF063S1T2 B 100 K	GF063S1 B 100 K
20	200	GF063S1T B 200 K	GF063S1T2 B 200 K	GF063S1 B 200 K
50	500	GF063S1T B 500 K	GF063S1T2 B 500 K	GF063S1 B 500 K
100	101	GF063S1T B 101 K	GF063S1T2 B 101 K	GF063S1 B 101 K
200	201	GF063S1T B 201 K	GF063S1T2 B 201 K	GF063S1 B 201 K
500	501	GF063S1T B 501 K	GF063S1T2 B 501 K	GF063S1 B 501 K
1,000	102	GF063S1T B 102 K	GF063S1T2 B 102 K	GF063S1 B 102 K
2,000	202	GF063S1T B 202 K	GF063S1T2 B 202 K	GF063S1 B 202 K
5,000	502	GF063S1T B 502 K	GF063S1T2 B 502 K	GF063S1 B 502 K
10,000	103	GF063S1T B 103 K	GF063S1T2 B 103 K	GF063S1 B 103 K
20,000	203	GF063S1T B 203 K	GF063S1T2 B 203 K	GF063S1 B 203 K
50,000	503	GF063S1T B 503 K	GF063S1T2 B 503 K	GF063S1 B 503 K
100,000	104	GF063S1T B 104 K	GF063S1T2 B 104 K	GF063S1 B 104 K
200,000	204	GF063S1T B 204 K	GF063S1T2 B 204 K	GF063S1 B 204 K
500,000	504	GF063S1T B 504 K	GF063S1T2 B 504 K	GF063S1 B 504 K
1,000,000	105	GF063S1T B 105 K	GF063S1T2 B 105 K	GF063S1 B 105 K
2,000,000	205	GF063S1T B 205 K	GF063S1T2 B 205 K	GF063S1 B 205 K
5,000,000	505	GF063S1T B 505 K	GF063S1T2 B 505 K	GF063S1 B 505 K



**GF063S1**

**GF063X Through-Hole, X Terminal Style, Cross-Slot, Side Adjust**

10	100	—	GF063XT2 B 100 K	GF063X B 100 K
20	200	—	GF063XT2 B 200 K	GF063X B 200 K
50	500	—	GF063XT2 B 500 K	GF063X B 500 K
100	101	—	GF063XT2 B 101 K	GF063X B 101 K
200	201	—	GF063XT2 B 201 K	GF063X B 201 K
500	501	—	GF063XT2 B 501 K	GF063X B 501 K
1,000	102	—	GF063XT2 B 102 K	GF063X B 102 K
2,000	202	—	GF063XT2 B 202 K	GF063X B 202 K
5,000	502	—	GF063XT2 B 502 K	GF063X B 502 K
10,000	103	—	GF063XT2 B 103 K	GF063X B 103 K
20,000	203	—	GF063XT2 B 203 K	GF063X B 203 K
50,000	503	—	GF063XT2 B 503 K	GF063X B 503 K
100,000	104	—	GF063XT2 B 104 K	GF063X B 104 K
200,000	204	—	GF063XT2 B 204 K	GF063X B 204 K
500,000	504	—	GF063XT2 B 504 K	GF063X B 504 K
1,000,000	105	—	GF063XT2 B 105 K	GF063X B 105 K
2,000,000	205	—	GF063XT2 B 205 K	GF063X B 205 K
5,000,000	505	—	GF063XT2 B 505 K	GF063X B 505 K



**GF063X**

**GF063X1 Through-Hole, X1 Terminal Style, Cross-Slot, Side Adjust**

10	100	—	GF063X1T2 B 100 K	GF063X1 B 100 K
20	200	—	GF063X1T2 B 200 K	GF063X1 B 200 K
50	500	—	GF063X1T2 B 500 K	GF063X1 B 500 K
100	101	—	GF063X1T2 B 101 K	GF063X1 B 101 K
200	201	—	GF063X1T2 B 201 K	GF063X1 B 201 K
500	501	—	GF063X1T2 B 501 K	GF063X1 B 501 K
1,000	102	—	GF063X1T2 B 102 K	GF063X1 B 102 K
2,000	202	—	GF063X1T2 B 202 K	GF063X1 B 202 K
5,000	502	—	GF063X1T2 B 502 K	GF063X1 B 502 K
10,000	103	—	GF063X1T2 B 103 K	GF063X1 B 103 K
20,000	203	—	GF063X1T2 B 203 K	GF063X1 B 203 K
50,000	503	—	GF063X1T2 B 503 K	GF063X1 B 503 K
100,000	104	—	GF063X1T2 B 104 K	GF063X1 B 104 K
200,000	204	—	GF063X1T2 B 204 K	GF063X1 B 204 K
500,000	504	—	GF063X1T2 B 504 K	GF063X1 B 504 K
1,000,000	105	—	GF063X1T2 B 105 K	GF063X1 B 105 K
2,000,000	205	—	GF063X1T2 B 205 K	GF063X1 B 205 K
5,000,000	505	—	GF063X1T2 B 505 K	GF063X1 B 505 K



**GF063X1**

\*Substitute code letter M in place of K at end of catalog part number for ±20% resistance tolerance.

Nominal Resistance		Resistance Tolerance: K = ±10% (see footnote for M = ±20%)			Potentiometer Styles
Value (Ω)	Code	Catalog No.* Tape & Reel	Catalog No.* Tape & Ammo Box	Catalog No.* Bulk	

**GF063V Through-Hole, V Terminal Style, Cross-Slot, Side Adjust**

10	100	GF063VT B 100 K	GF063VT2 B 100 K	GF063V B 100 K
20	200	GF063VT B 200 K	GF063VT2 B 200 K	GF063V B 200 K
50	500	GF063VT B 500 K	GF063VT2 B 500 K	GF063V B 500 K
100	101	GF063VT B 101 K	GF063VT2 B 101 K	GF063V B 101 K
200	201	GF063VT B 201 K	GF063VT2 B 201 K	GF063V B 201 K
500	501	GF063VT B 501 K	GF063VT2 B 501 K	GF063V B 501 K
1,000	102	GF063VT B 102 K	GF063VT2 B 102 K	GF063V B 102 K
2,000	202	GF063VT B 202 K	GF063VT2 B 202 K	GF063V B 202 K
5,000	502	GF063VT B 502 K	GF063VT2 B 502 K	GF063V B 502 K
10,000	103	GF063VT B 103 K	GF063VT2 B 103 K	GF063V B 103 K
20,000	203	GF063VT B 203 K	GF063VT2 B 203 K	GF063V B 203 K
50,000	503	GF063VT B 503 K	GF063VT2 B 503 K	GF063V B 503 K
100,000	104	GF063VT B 104 K	GF063VT2 B 104 K	GF063V B 104 K
200,000	204	GF063VT B 204 K	GF063VT2 B 204 K	GF063V B 204 K
500,000	504	GF063VT B 504 K	GF063VT2 B 504 K	GF063V B 504 K
1,000,000	105	GF063VT B 105 K	GF063VT2 B 105 K	GF063V B 105 K
2,000,000	205	GF063VT B 205 K	GF063VT2 B 205 K	GF063V B 205 K
5,000,000	505	GF063VT B 505 K	GF063VT2 B 505 K	GF063V B 505 K



**GF063V**

**GF063V1 Through-Hole, V1 Terminal Style, Cross-Slot, Side Adjust**

10	100	GF063V1T B 100 K	GF063V1T2 B 100 K	GF063V1 B 100 K
20	200	GF063V1T B 200 K	GF063V1T2 B 200 K	GF063V1 B 200 K
50	500	GF063V1T B 500 K	GF063V1T2 B 500 K	GF063V1 B 500 K
100	101	GF063V1T B 101 K	GF063V1T2 B 101 K	GF063V1 B 101 K
200	201	GF063V1T B 201 K	GF063V1T2 B 201 K	GF063V1 B 201 K
500	501	GF063V1T B 501 K	GF063V1T2 B 501 K	GF063V1 B 501 K
1,000	102	GF063V1T B 102 K	GF063V1T2 B 102 K	GF063V1 B 102 K
2,000	202	GF063V1T B 202 K	GF063V1T2 B 202 K	GF063V1 B 202 K
5,000	502	GF063V1T B 502 K	GF063V1T2 B 502 K	GF063V1 B 502 K
10,000	103	GF063V1T B 103 K	GF063V1T2 B 103 K	GF063V1 B 103 K
20,000	203	GF063V1T B 203 K	GF063V1T2 B 203 K	GF063V1 B 203 K
50,000	503	GF063V1T B 503 K	GF063V1T2 B 503 K	GF063V1 B 503 K
100,000	104	GF063V1T B 104 K	GF063V1T2 B 104 K	GF063V1 B 104 K
200,000	204	GF063V1T B 204 K	GF063V1T2 B 204 K	GF063V1 B 204 K
500,000	504	GF063V1T B 504 K	GF063V1T2 B 504 K	GF063V1 B 504 K
1,000,000	105	GF063V1T B 105 K	GF063V1T2 B 105 K	GF063V1 B 105 K
2,000,000	205	GF063V1T B 205 K	GF063V1T2 B 205 K	GF063V1 B 205 K
5,000,000	505	GF063V1T B 505 K	GF063V1T2 B 505 K	GF063V1 B 505 K



**GF063V1**

\*Substitute code letter M in place of K at end of catalog part number for ±20% resistance tolerance.

**Packaging**

**Standard:**

**Tape & Reel Packaging**

PT, P1T, UT, ST, S1T, VT, V1T  
1,000 pieces per 14.3" reel.

**Tape & Ammo Packaging**

PT2, P1T2, UT2, ST2, S1T2, XT2, X1T2, VT2, V1T2  
1,000 pieces per ammo box.

**Bulk Packaging**

All GF063 Models  
50 pieces per vinyl bag.  
500 pieces per box.

**Soldering and Cleaning Guidelines**

For soldering, cleaning and other information, refer to Guidelines and Precautions for Using Potentiometers.