

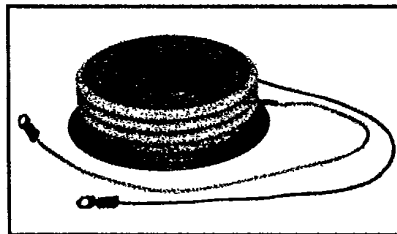

FT2500BH

Powerex, Inc. Hills Street, Youngwood, Pennsylvania 15697 (412) 925-7272
 Powerex Europe, S.A., 428 Ave. G. Durand, BP107, 72003 LeMans, France (43) 72.75.15

Phase Control SCR
2500 Amperes Avg
1600-2800 Volts

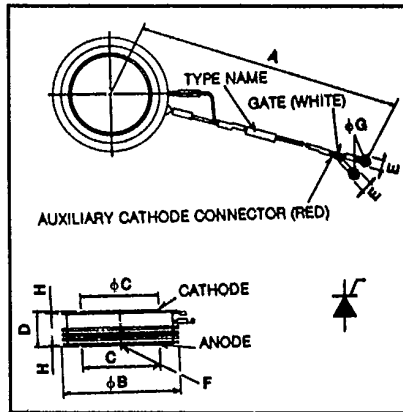

FT2500BH
Phase Control SCR
 2500 Amperes/1600-2800 Volts

FT2500BH
Outline Drawing

Dimensions	Inches	Metric
A	17.13 ± .40	435 ± 10
φB	4.73 Max	120 Max
φC	3.15	80
D	1.38 ± .02	35 ± 0.5
E	.30	7.5
F	M5	M5 × 0.8
φG	.169	4.3
H	.015 Min	0.4 Min

Description

Powerex Silicon Controlled Rectifiers (SCR) are designed for phase control applications. These are all-diffused, Press-Pak (Pow-R-Disc) devices employing the field-proven amplifying (di/namic) gate.

Features:

- Low On-State Voltage
- High di/dt
- High dv/dt
- Hermetic Packaging
- Excellent Surge and I²t Ratings

Applications:

- Power Supplies
- Battery Chargers
- Motor Control
- Light Dimmers
- VAR Generators

Ordering Information

Example: Select the complete ten digit part number you desire from the table - i.e. FT2500BH-40 is a 2000 Volt, 2500 Ampere Phase Control SCR.

Type	Voltage		Current
	V _{ORM} V _{RRM}	Code	I _T (avg)
FT2500BH	1600	-32	2500
	1800	-36	
	2000	-40	
	2500	-50	
	2800	-56	



Powerex, Inc., Hillis Street, Youngwood, Pennsylvania 15697 (412) 925-7272

Powerex Europe, S.A., 428 Ave. G. Durand, BP107, 72003 LeMans, France (43) 72.75.15

FT2500BH

Phase Control SCR

2500 Amperes Avg/1600-2800 Volts

Absolute Maximum Ratings

	Symbol	FT2500BH	Units
RMS On-State Current	$I_{T(RMS)}$	3900	Amperes
Average On-State Current	$I_{T(av)}$	2500	Amperes
Peak One-Cycle Surge (Non Repetitive) On-State Current (60Hz)	I_{TSM}	50×10^3	Amperes
Peak One-Cycle Surge (Non-Repetitive) On-State Current (50Hz)	I_{TSM}	45.6×10^3	Amperes
Critical Rate-of-Rise of On-State Current (Non-Repetitive)	di/dt	600	Amperes/ μ s
Critical Rate-of-Rise of On-State Current (Repetitive)	di/dt	250	Amperes/ μ s
I^2t (for Fusing), one cycle at 60Hz	I^2t	1.0×10^7	A ² sec
Peak Gate Power Dissipation	P_{GM}	30	Watts
Average Gate Power Dissipation	$P_{G(av)}$	8	Watts
Storage Temperature	T_{STG}	-40 to 150	°C
Operating Temperature	T_J	-40 to 125	°C
Mounting Force [Ⓞ]		8800 to 11,400	lb.
Mounting Force [Ⓞ]		4000 to 5200	kg

Electrical and Thermal Characteristics

Characteristics	Symbol	Test Conditions	FT2500BH	Units
Voltage—Blocking State Maximums				
Forward Leakage, Peak	I_{DRM}	$T_J = 125^\circ\text{C}$, V_{DRM} applied	300	mA
Reverse Leakage, Peak	I_{RRM}	$T_J = 125^\circ\text{C}$, V_{RRM} applied	300	mA
Current—Conducting State Maximums				
Peak On-State Voltage	V_{TM}	$I_{TM} = 8000\text{A}$, $T_J = 125^\circ\text{C}$	2.20	Volts
Switching				
Min. Critical dv/dt exponential to V_{DRM}	dv/dt	$T_J = 125^\circ\text{C}$, $V_D = \frac{1}{2}V_{DRM}$	1000	V/ μ sec
Thermal				
Maximum Thermal Resistance, [Ⓞ] double sided cooling Junction to Sink	$R_{\theta JS}$.01	°C/Watt
Gate—Maximum Parameters				
Gate Current to Trigger	I_{GT}	$V_D = 6\text{V}$, $T_J = 25^\circ\text{C}$, $R_L = 2\Omega$	250	mA
Gate Voltage to Trigger	V_{GT}	$V_D = 6\text{V}$, $T_J = 25^\circ\text{C}$, $R_L = 2\Omega$	3.5	Volts
Non-Triggering Gate Voltage	V_{GDM}	$T_J = 125^\circ\text{C}$, $V_D = \frac{1}{2}V_{DRM}$.20	Volts
Peak Forward Gate Current	I_{GTM}		6	Amperes
Peak Reverse Gate Voltage	V_{GRM}		10	Volts

[Ⓞ] Consult recommended mounting procedures.



Powerex, Inc., Hillis Street, Youngwood, Pennsylvania 15697 (412) 925-7272
 Powerex Europe, S.A., 428 Ave. G. Durand, BP107, 72003 LeMans, France (43) 72.75.15

FT2500BH
 Phase Control SCR
 2500 Amperes Avg/1600-2800 Volts

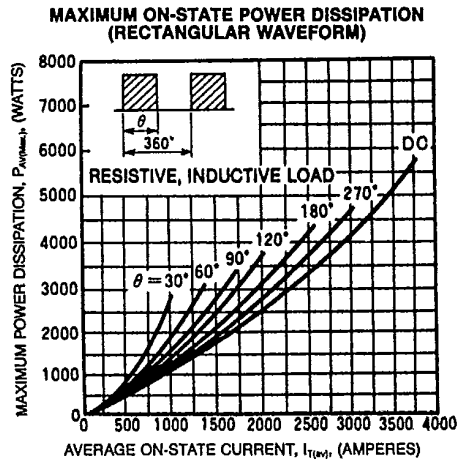
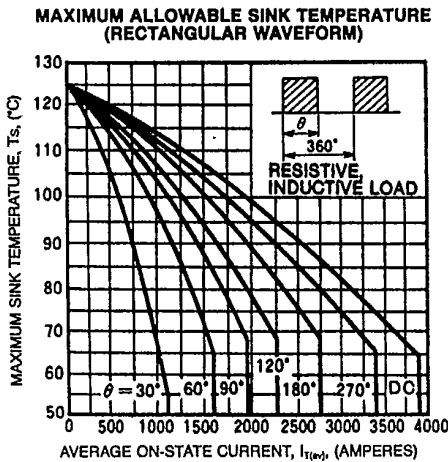
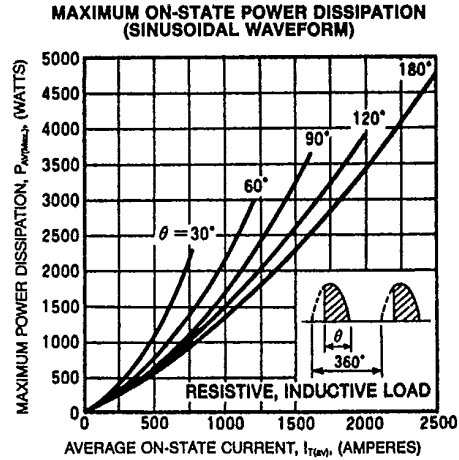
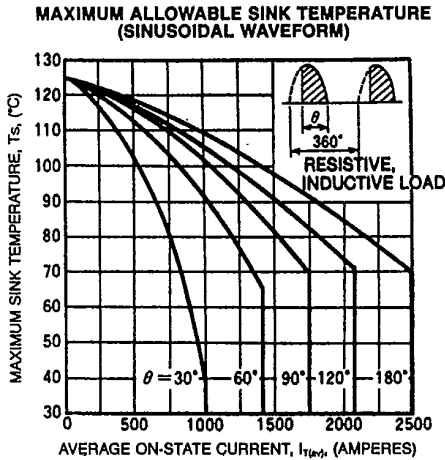
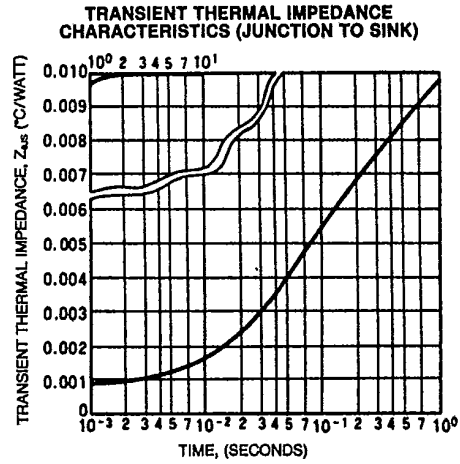
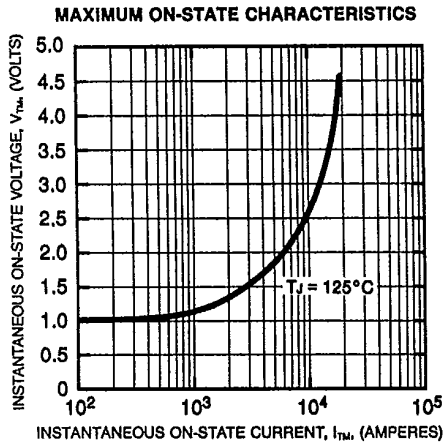



Powerex, Inc., Hillis Street, Youngwood, Pennsylvania 15697 (412) 925-7272
 Powerex Europe, S.A., 428 Ave. G. Durand, BP107, 72003 LeMans, France (43) 72.75.15

FT2500BH
 Phase Control SCR
 2500 Amperes Avg/1600-2800 Volts

