



PA3431

CMOS IC

2W STEREO AUDIO AMPLIFIER

DESCRIPTION

As a stereo audio speaker which is operating on a single 5V supply, the UTC **PA3431** is capable of delivering 2W of output power per channel into 4Ω loads in Bridge-Tied Load (BTL) mode with less than 1% THD+N. Way of two terminals (GAIN0 and GAIN1) can configured and control the amplifier gain. It also provided BTL gain settings of 6 dB, 10 dB, 15.6 dB, and 21.6 dB (inverting). Other features: the SHDN mode is supported to disable UTC **PA3431** for the low current consumption applications; the current consumption can be reduced to typically 150μA.

FEATURES

- * 2W Output power into 4Ω load from 5V supply each channel
- * Gain control internally
- * Differential input fully
- * Depop circuitry
- * Shutdown protection thermally

ORDERING INFORMATION

Ordering Number		Package	Packing
Normal	Lead Free Plating		
PA3431-N20-R	PA3431L-N20-R	HTSSOP-20	Tape Reel
PA3431-N20-T	PA3431L-N20-T	HTSSOP-20	Tube

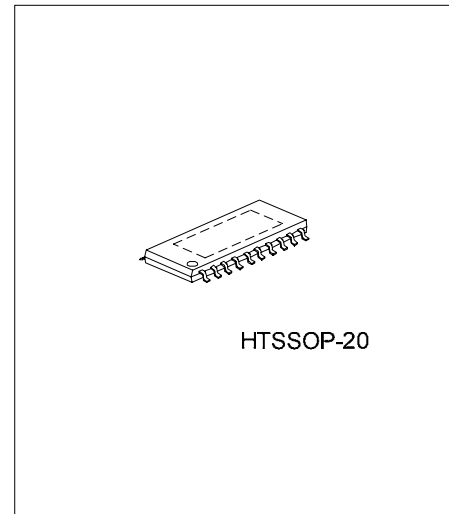

*Pb-free plating product number: PA3431L

<p>PA3431L-N20-T</p> <p>(1)Packing Type (2)Package Type (3)Lead Plating</p>	<p>(1) R: Tape Reel, T: Tube (2) N20: HTSSOP-20 (3) L: Lead Free Plating, Blank: Pb/Sn</p>
---	--

■ PIN CONFIGURATION

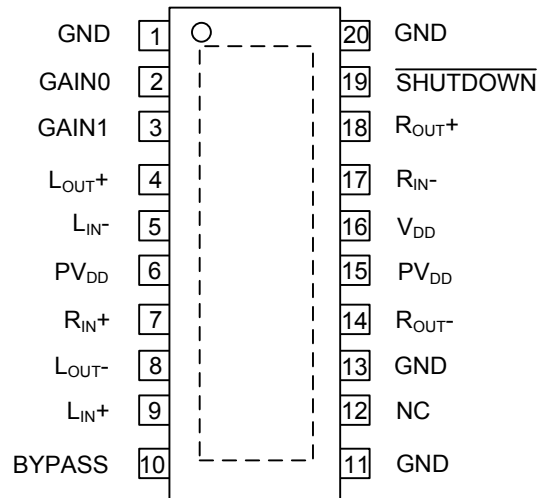

■ PIN DESCRIPTION

PIN NO.	PIN NAME	I/O	DESCRIPTION
1,11 13,20	GND		Ground
2	GAIN0	I	Bit 0 of gain control
3	GAIN1	I	Bit 1 of gain control
4	L_OUT+	O	Positive output for left channel
5	L_IN-	I	Negative differential input for left channel
6,15	PV_DD	I	Supply voltage
7	R_IN+	I	Positive differential input for right channel
8	L_OUT-	O	Negative output for left channel
9	L_IN+	I	Positive differential input for left channel
10	BYPASS		Tap to voltage divider for internal mid supply bias generator
12	NC		Nothing connection
14	R_OUT-	O	Negative output for right channel
16	V_DD		Supply voltage
17	R_IN-	I	Negative differential input for right channel
18	R_OUT+	O	Positive output for right channel
19	SHUTDOWN	I	In shutdown mode when held low

■ ABSOLUTE MAXIMUM RATINGS

PARAMETER	SYMBOL	RATINGS	UNIT
Supply Voltage	V_{CC}	6	V
Power Dissipation ($T_A \leq 25$)	P_D	2.7	W
Junction Temperature	T_J	+150	
Operating Temperature	T_{OPR}	-40 ~ +85	
Storage Temperature Range	T_{STG}	-65 ~ +150	

Note: Absolute maximum ratings are those values beyond which the device could be permanently damaged.

Absolute maximum ratings are stress ratings only and functional device operation is not implied.

■ ELECTRICAL CHARACTERISTICS ($T_a=25$, unless otherwise specified)

PARAMETER	SYMBOL	TEST CONDITIONS	MIN	TYP	MAX	UNIT
DC ELECTRICAL CHARACTERISTICS						
Supply Voltage	V_{DD}		4.5	5	5.5	V
High-Level Input Voltage	V_{IH}	SHUTDOWN, GAIN0, GAIN1	2			V
Low-Level Input Voltage	V_{IL}	SHUTDOWN, GAIN0, GAIN1			0.8	V
DC Differential Output Voltage	$V_{O(DIFF)}$	$V_{DD}=5V, Gain=2$		5	50	mV
Supply Current in Mute Mode	I_{DD}	$V_{DD}=5V, Stereo BTL$		7.5	11	mA
Supply Current, Shutdown Mode	$I_{DD(SD)}$	$V_{DD}=5V$		160	300	μA
AC ELECTRICAL CHARACTERISTICS ($V_{DD}=5.0V, R_L=4\Omega$)						
Output Power	P_{OUT}	THD =1%, BTL, $R_L=4\Omega, G=-2V/V$		2		W
		THD =1%, BTL, $R_L=8\Omega, G=-2V/V$		1.2		
		THD =10%, BTL, $R_L=4\Omega, G=-2V/V$		2.5		
		THD = 10%, BTL, $R_L=8\Omega, G=-2V/V$		1.6		
Total Harmonic Distortion Plus Noise	THD+N	$P_{OUT}=1.6W, BTL, R_L=4\Omega, G=-2V/V$		100		m%
		$P_{OUT}=1W, BTL, R_L=8\Omega, G=-2V/V$		60		
Max Output Power Bandwidth	B_{OM}	THD = 5%		15		kHz
Power Supply Ripple Rejection	PSRR	$F=1kHz, BTL, G=-2V/V, C_{BYP}=1\mu F$		68		dB
Channel-to-Channel Output Separation		$f=1kHz$		80		dB
Signal-to-Noise Ratio	SNR	$P_{OUT}=500mW, BTL, G=-2V/V$		90		dB
Output Noise Voltage	V_N	BTL, $G=-2V/V, A$ Weighted filter		45		μV (rms)

Note: Output power is measured at the output terminals of the IC at 1kHz.

■ TYPICAL APPLICATION CIRCUIT

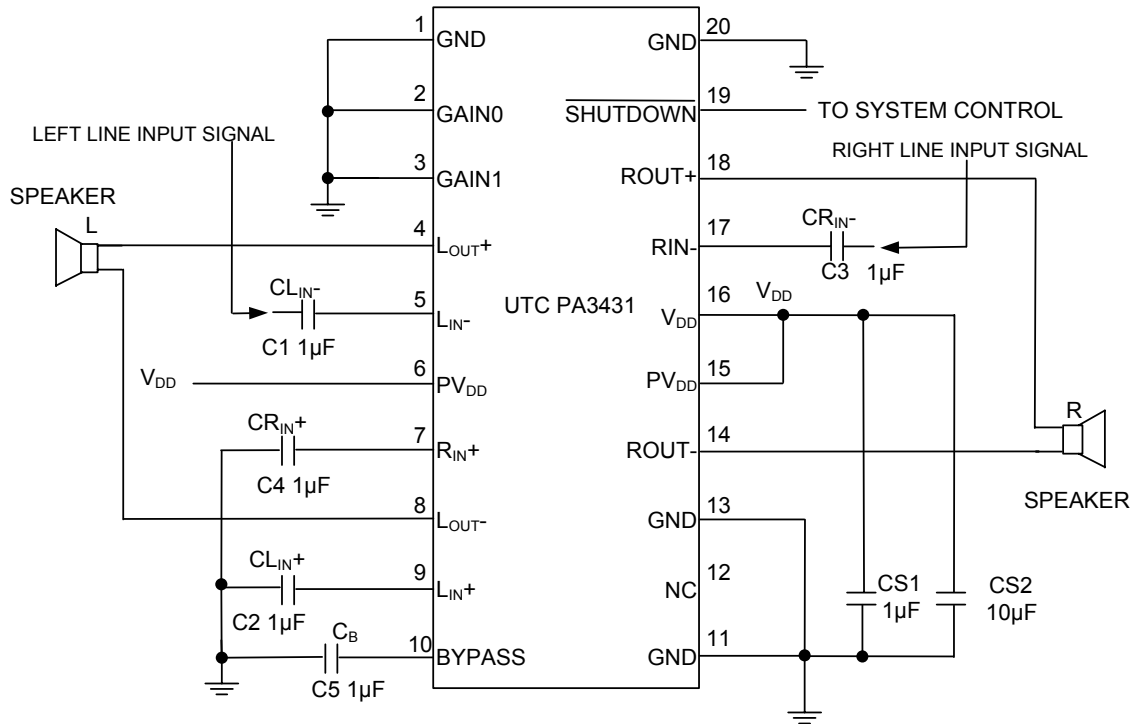

Typical Application Circuit Using Single-Ended Inputs

■ TYPICAL APPLICATION CIRCUIT(Cont.)

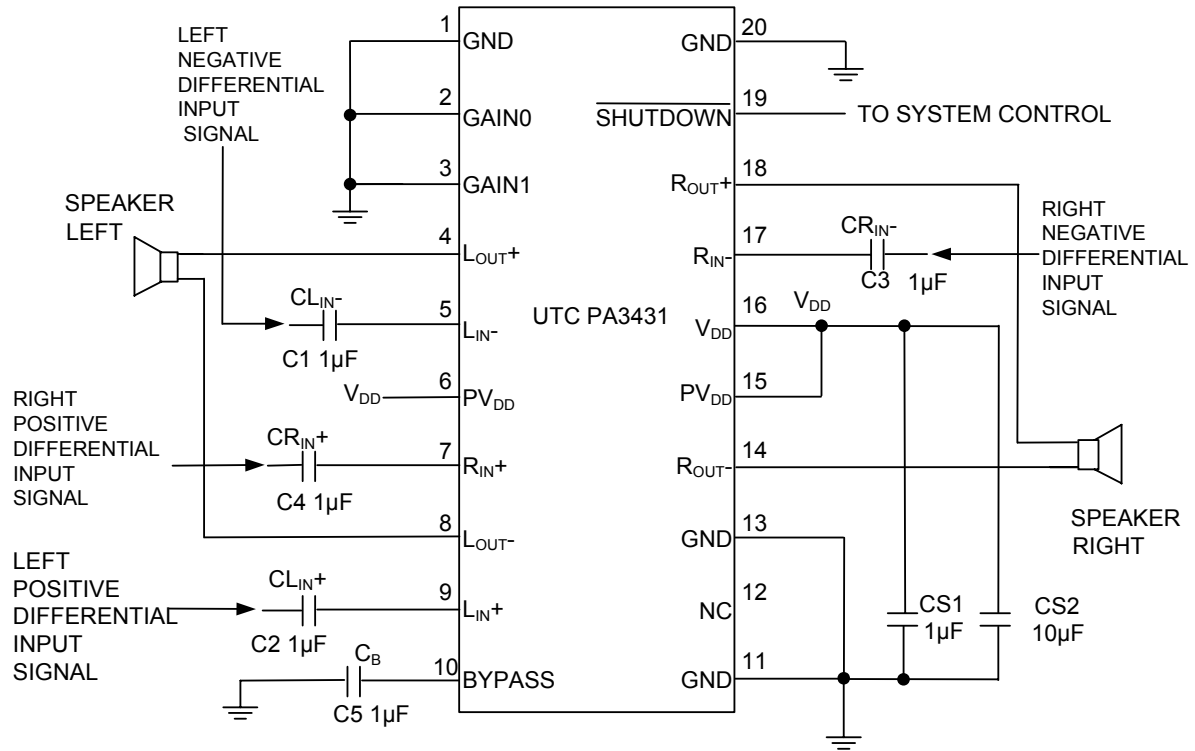

Typical Application Circuit Using Differential Inputs

■ APPLICATION INFORMATION

Shutdown Mode Operating

SHUTDOWN PIN INPUT	THE AMPLIFIER'S OUTPUT
LOW	MUTE(the current of this device will be reduced to 160μA)
HIGH	BTL
OTHERS	Don't Care

C_i(Input Capacitor)

The value of C_i is important to consider as it directly affects the bass performance of the application circuit. When C_i is required to allow the amplifier to bias the input signal to the proper dc level for optimum operation, it's value can be calculate by this equation:

$$C_i = 1 / (2\pi R_i F_c)$$

R_i:Input Impedance

F_c:High-pass Filter's Frequency

The low leakage tantalum or ceramic capacitors are suggested to be used as the input coupling capacitors, because of the small leakage current of the input ca-pacitors will cause the dc offset voltage at the input to the amplifier that reduces the operation headroom, especially at the high gain applications. It is important to let the positive side connecting to the higher dc level of the application when using the polarized capacitors.

Gain setting (VS GAIN0, GAIN1 and R_i)

Gain setting is determined by GAIN0 and GAIN1. The gains listed in the next table are realized by changing the taps on the input resistors inside the amplifier which will cause the internal input impedance(R_i) to be dependent on the gain setting as we can see listed in the next table.

A _v (dB)	GAIN0	GAIN1	R _i (kΩ)
6	0	0	90
10	0	1	70
15.6	1	0	45
21.6	1	1	30

■ TYPICAL CHARACTERISTICS

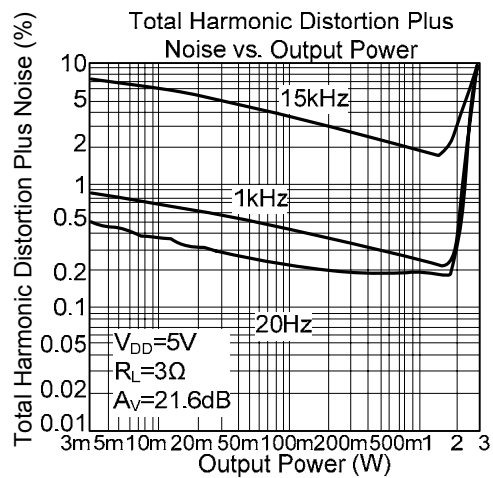
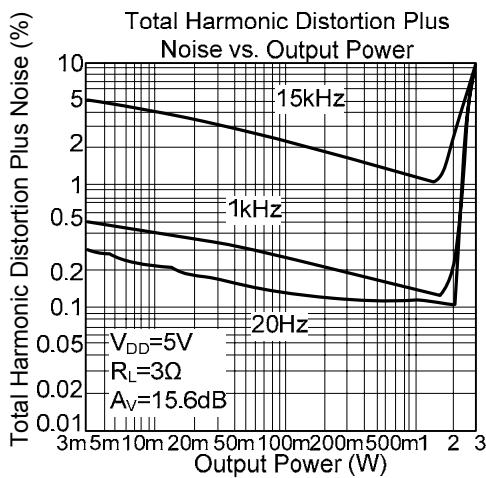
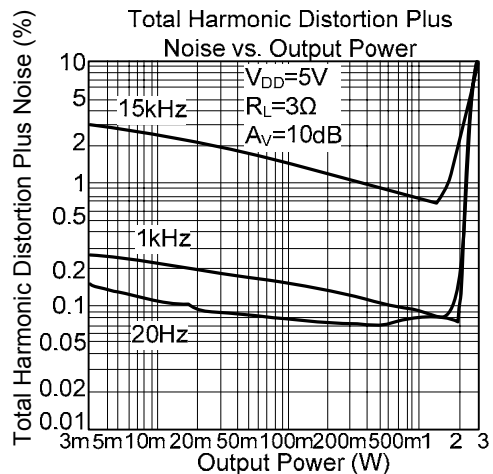
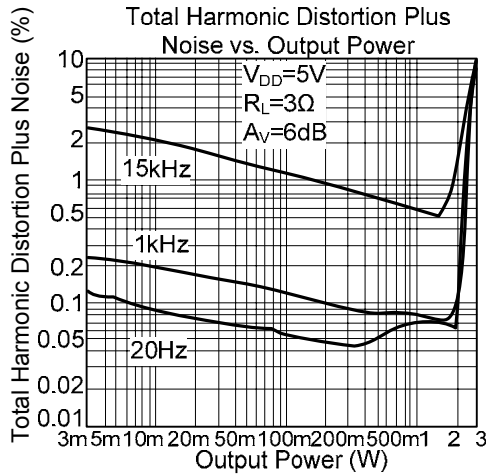
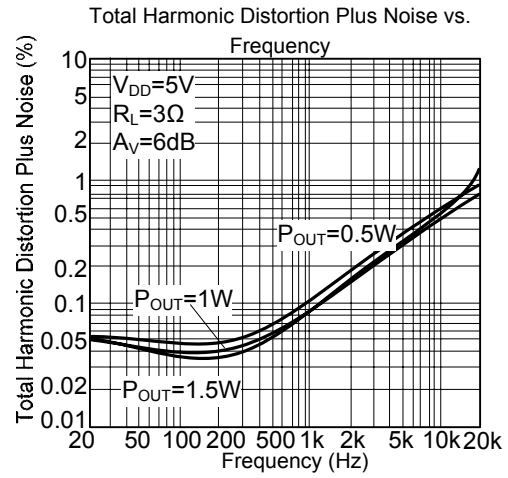
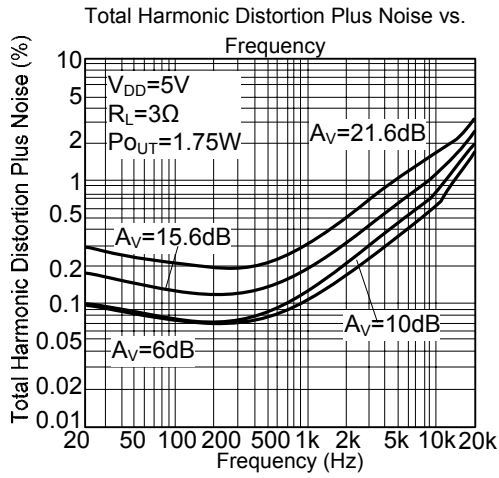

■ TYPICAL CHARACTERISTICS(Cont.)

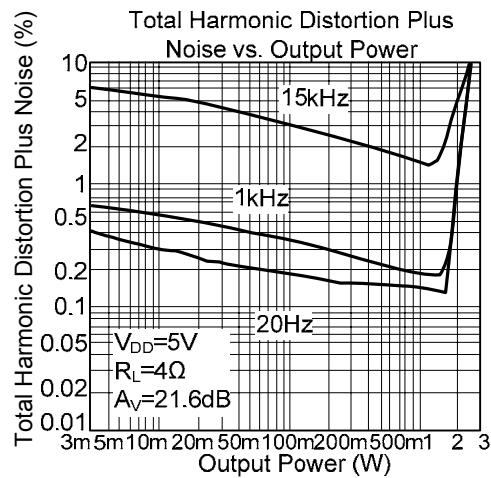
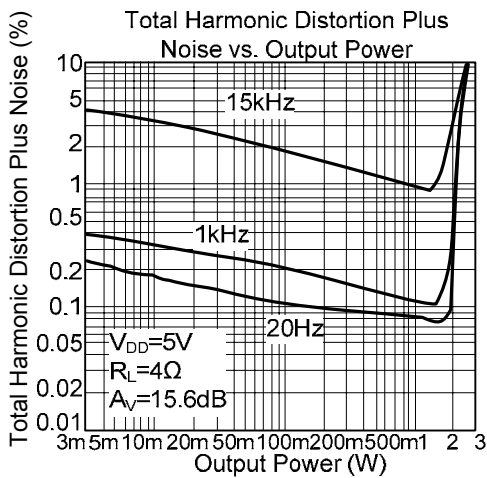
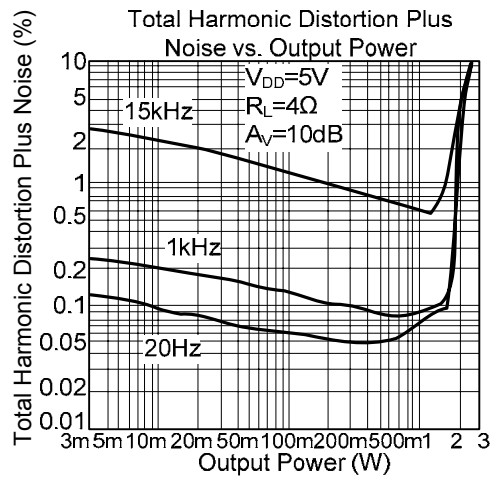
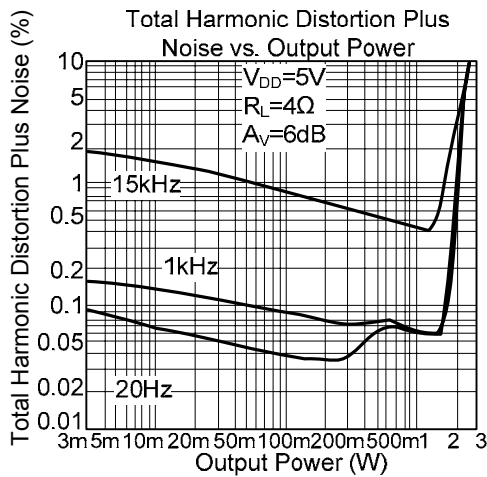
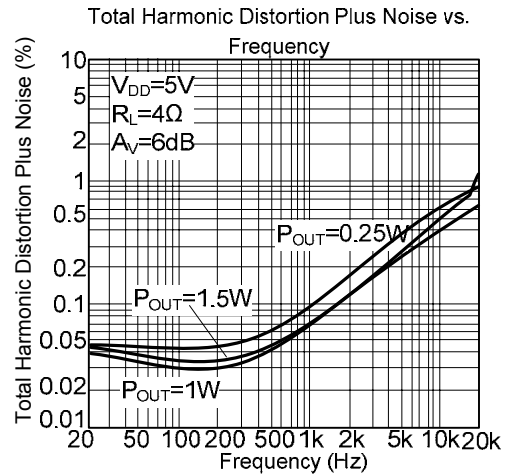
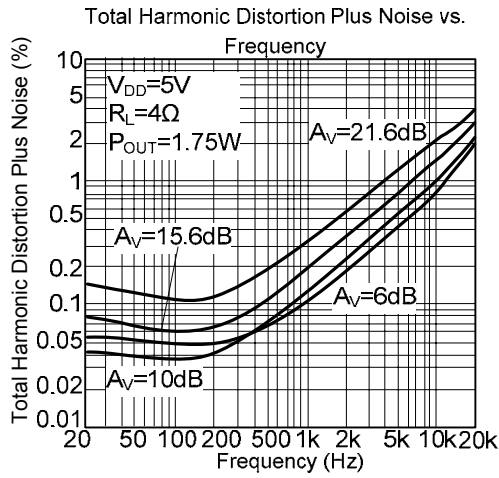

■ TYPICAL CHARACTERISTICS(Cont.)

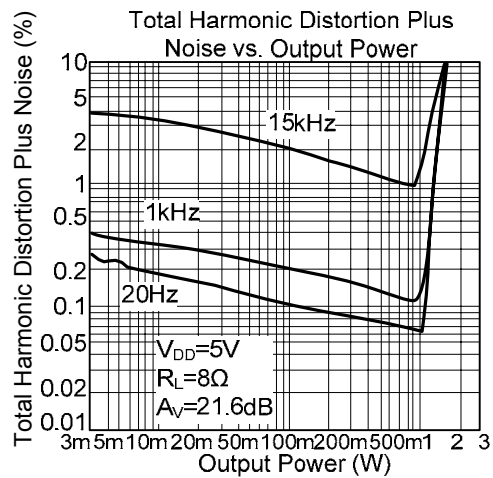
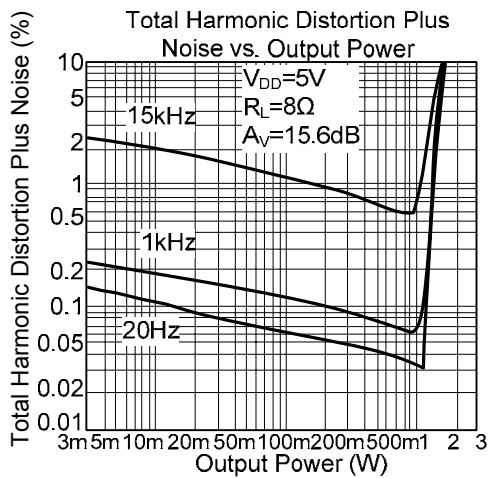
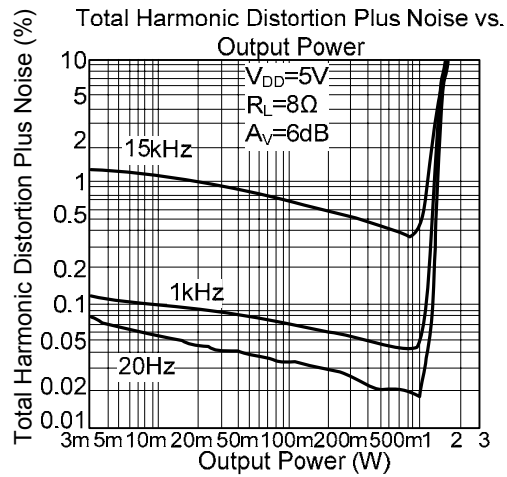
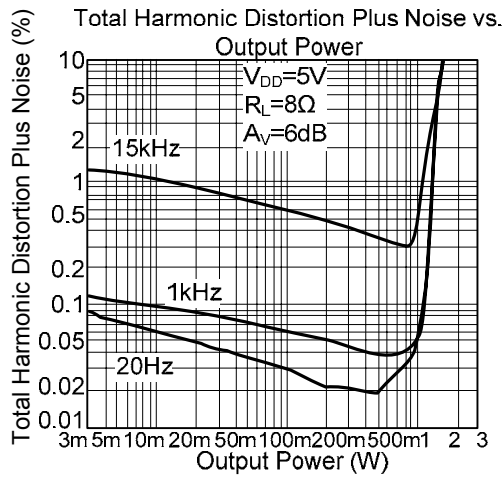
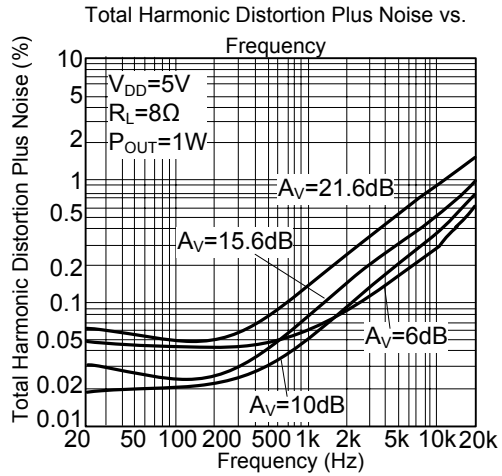
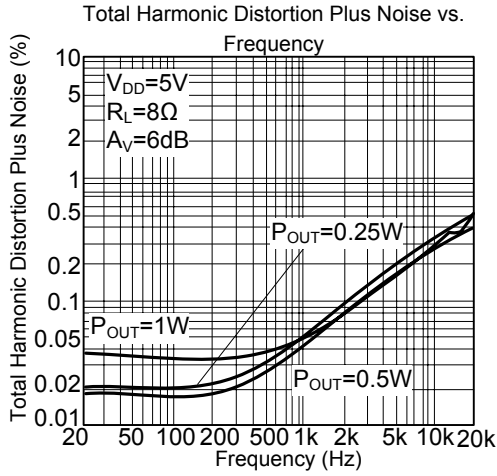

■ TYPICAL CHARACTERISTICS(Cont.)

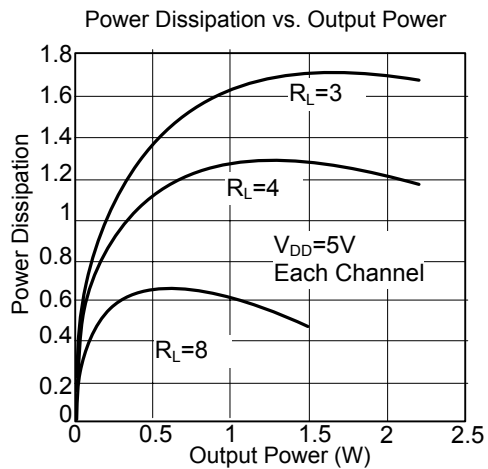
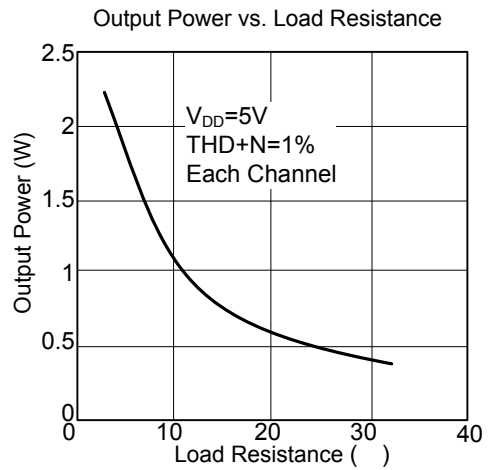
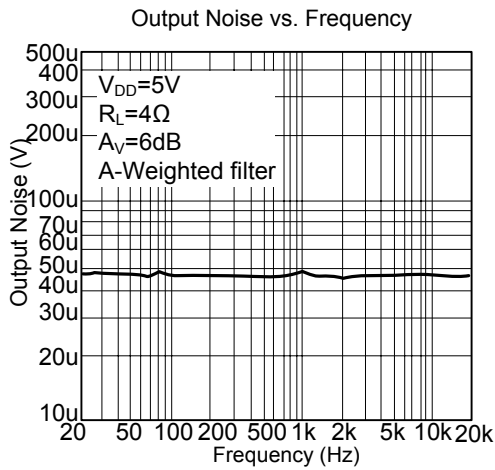
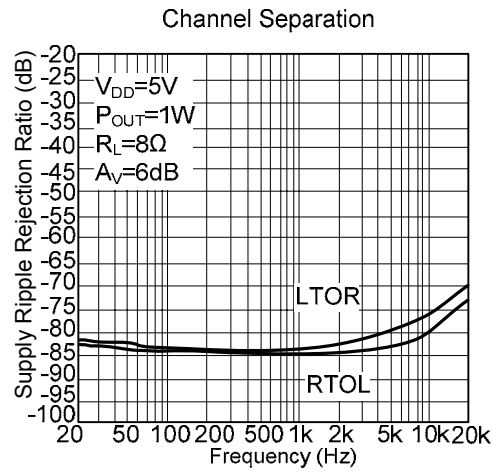
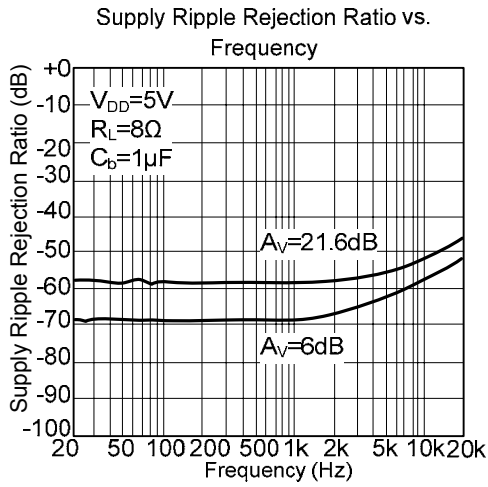

UTC assumes no responsibility for equipment failures that result from using products at values that exceed, even momentarily, rated values (such as maximum ratings, operating condition ranges, or other parameters) listed in products specifications of any and all UTC products described or contained herein. UTC products are not designed for use in life support appliances, devices or systems where malfunction of these products can be reasonably expected to result in personal injury. Reproduction in whole or in part is prohibited without the prior written consent of the copyright owner. The information presented in this document does not form part of any quotation or contract, is believed to be accurate and reliable and may be changed without notice.