

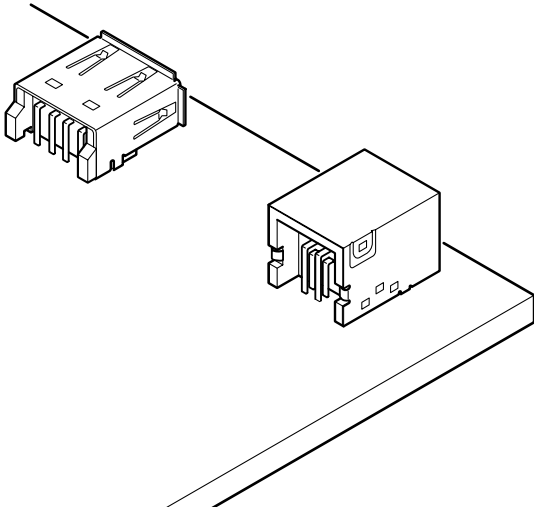

UB CONNECTOR

USB (Universal Serial Bus) Conforming Connector



- **Conforms to USB (Universal Serial Bus) 2.0 standards**
- **Secure EMI shielding effect**
- **SMT configuration**

Specifications

- Current rating: 1.0 A AC, DC/Line
 - Voltage rating: 30 V AC, DC
 - Temperature range: -55°C to +85°C
(including temperature rise in applying electrical current)
 - Contact resistance: Initial value/ 30 mΩ max.
After environmental tests/ 10 mΩ max.
(variation from initial value)
 - Insulation resistance: 1,000 MΩ min.
 - Withstanding voltage: 750 VAC/minute
- * Refer to "General Instruction and Notice when using Terminals and Connectors" at the end of this catalog.
* Contact JST for details.
* Compliant with RoHS.

Standards

- Ⓜ Recognized E60389
- Ⓢ Certified LR20812

Receptacle

USB 2.0 certified product

Type A <Through-hole type> Normal

TID No.: 6000158

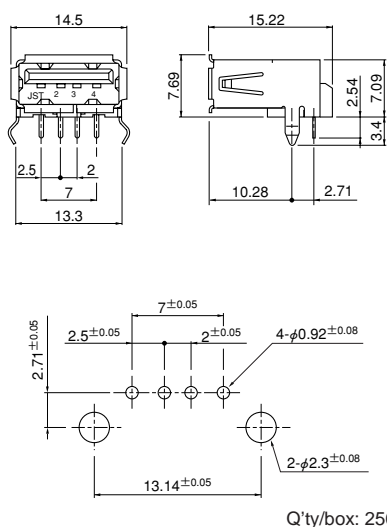

Type A <Through-hole type> With solder tab

TID No.: 6000162

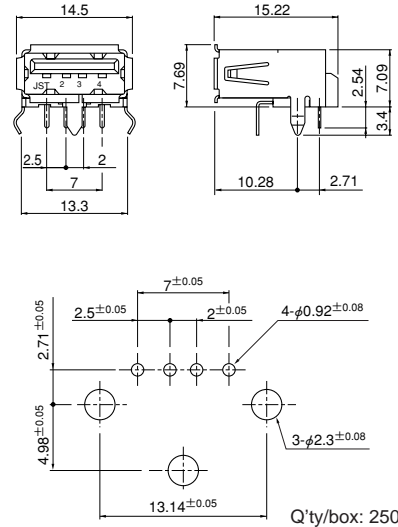

Type A <Through-hole type> With upper flange

TID No.: 6000163

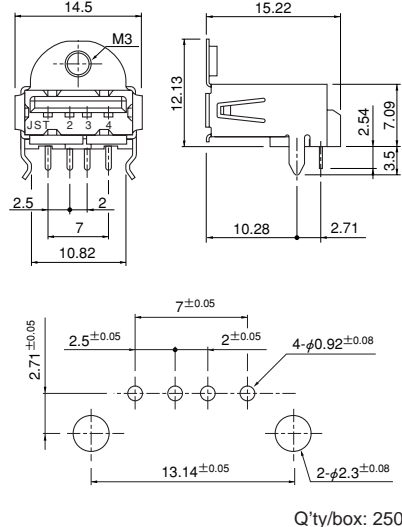

Model No.	Material and Finish	
UBA-4R-D14-4D	Contact	Copper alloy, nickel-undercoated, selective gold-plated
	Housing	Thermoplastic resin, UL94V-0
	Shell	Copper alloy, nickel-undercoated, tin-plated

RoHS compliance This product displays (LF)(SN) on a label.

Model No.	Material and Finish	
UBA-4R-D14T-4D	Contact	Copper alloy, nickel-undercoated, selective gold-plated
	Housing	Thermoplastic resin, UL94V-0
	Shell	Copper alloy, nickel-undercoated, tin-plated
	Solder tab	Copper alloy, copper-undercoated, tin-plated (reflow treatment)

RoHS compliance This product displays (LF)(SN) on a label.

Model No.	Material and Finish	
UBA-4R-D14C2-4D	Contact	Copper alloy, nickel-undercoated, selective gold-plated
	Housing	Thermoplastic resin, UL94V-0
	Shell	Copper alloy, nickel-undercoated, tin-plated

RoHS compliance This product displays (LF)(SN) on a label.

Note: 1. The dimensions above should serve as a guideline. Contact JST for details.

2. Thin gold-plated (Au Flash) product that is USB 2.0 uncertified product (** 10) is also available.

Receptacle

USB 2.0 certified product

Type A <Through-hole type> Reverse

TID No.: 61000434

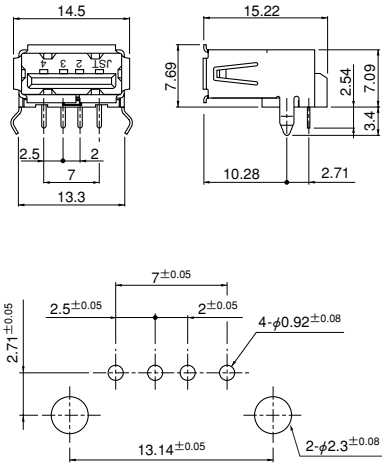

Q'ty/box: 250

Model No.	Material and Finish
UBA-R4R-D14-4D	Contact: Copper alloy, nickel-undercoated, selective gold-plated
	Housing: Thermoplastic resin, UL94V-0
	Shell: Copper alloy, nickel-undercoated, tin-plated

RoHS compliance This product displays (LF)(SN) on a label.

Type A <Through-hole type> Straight, normal

TID No.: 6000456

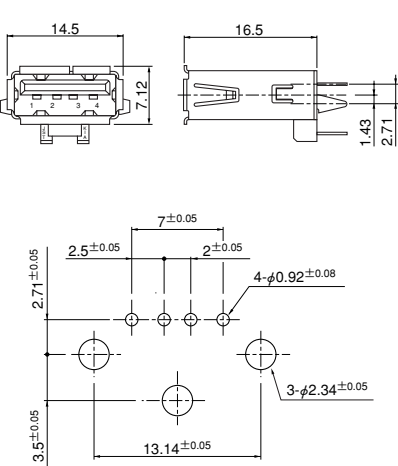

Q'ty/box: 250

Model No.	Material and Finish
UBAS-4R-D14D-4D	Contact: Copper alloy, nickel-undercoated, selective gold-plated
	Housing: Thermoplastic resin, UL94V-0
	Shell: Copper alloy, nickel-undercoated, tin-plated

RoHS compliance This product displays (LF)(SN) on a label.

Type A <Through-hole type> Vertical, normal

TID No.: 6000455

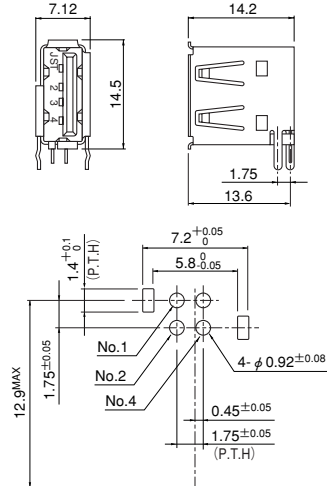

Q'ty/box: 350

Model No.	Material and Finish
UBAL-4R-D14-4S	Contact: Copper alloy, nickel-undercoated, selective gold-plated
	Housing: Thermoplastic resin, UL94V-0
	Shell: Copper alloy, nickel-undercoated, tin-plated

RoHS compliance This product displays (LF)(SN) on a label.

Type A <Through-hole type> Vertical, dual-row

TID No.: 6000455

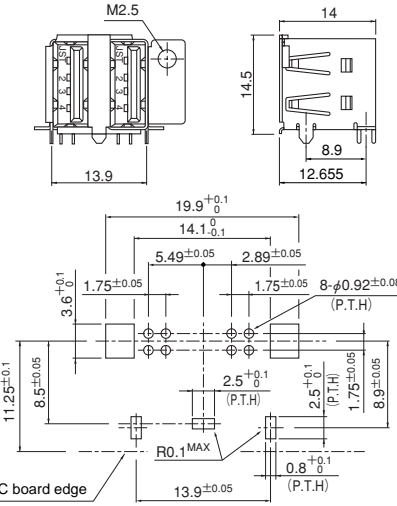

Q'ty/box: 105

Model No.	Material and Finish
UBAL-4RS-D14K-4S	Contact: Copper alloy, nickel-undercoated, selective gold-plated
	Housing: Thermoplastic resin, UL94V-0
	Shell A: Copper alloy, nickel-undercoated, tin-plated
	Shell B: Copper alloy, nickel-undercoated, tin-plated

RoHS compliance This product displays (LF)(SN) on a label.

Type A <Through-hole type> Double-stack

TID No.: 6000434

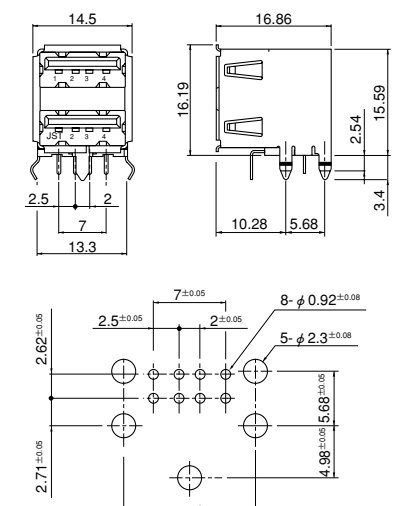

Q'ty/box: 210

Model No.	Material and Finish
UBA-4RS-D14T-4D	Contact: Copper alloy, nickel-undercoated, selective gold-plated
	Housing: Thermoplastic resin, UL94V-0
	Locator
	Shell A: Copper alloy, nickel-undercoated, tin-plated
	Shell B: Copper alloy, nickel-undercoated, tin-plated (reflow treatment)
Solder tab: Copper alloy, copper-undercoated, tin-plated (reflow treatment)	

RoHS compliance This product displays (LF)(SN) on a label.

Type A <Through-hole type> Double-stack with upper flange

TID No.: 61000434

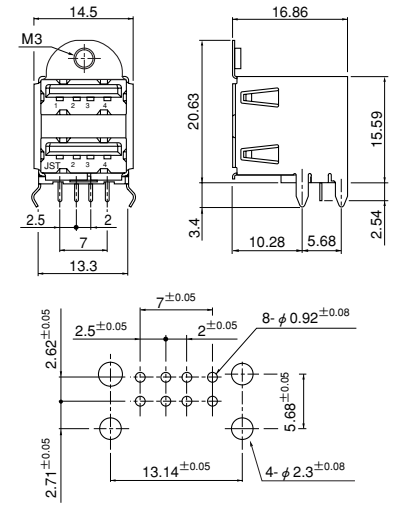

Q'ty/box: 210

Model No.	Material and Finish
UBA-4RS-D14C-4D	Contact: Copper alloy, nickel-undercoated, selective gold-plated
	Housing: Thermoplastic resin, UL94V-0
	Locator
	Shell A: Copper alloy, nickel-undercoated, tin-plated
Shell B: Copper alloy, nickel-undercoated, tin-plated	

RoHS compliance This product displays (LF)(SN) on a label.

Note: 1. The dimensions above should serve as a guideline. Contact JST for details.
2. Thin gold-plated (Au Flash) product that is USB 2.0 uncertified product (** 10) is also available.

UB CONNECTOR

Receptacle

USB 2.0 certified product

Type A <SMT type> Without flange

TID No.: 60000160

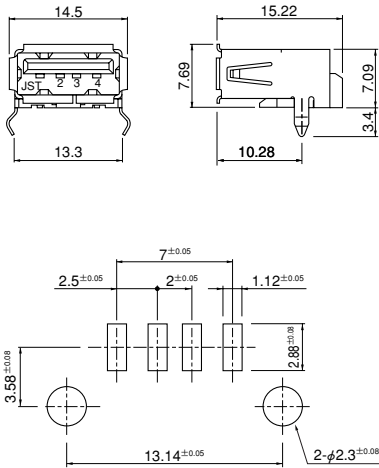

Q'ty/box: 250

Type A <SMT type> With side flange

TID No.: 6000171

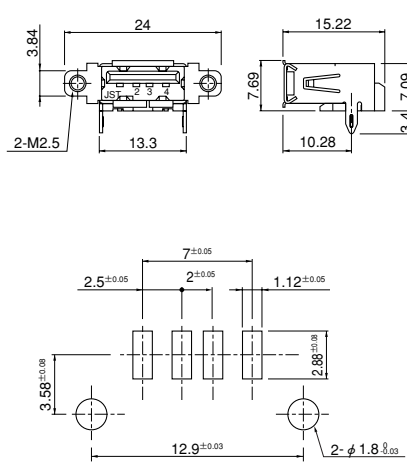

Q'ty/box: 192

Type A <SMT type, offset 3 mm> With side flange

TID No.: 60000172

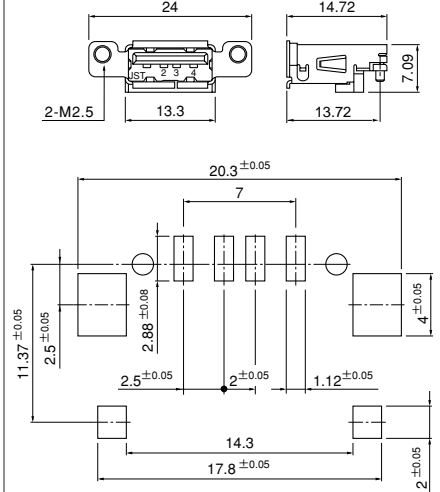

Q'ty/box: 378

Model No.	Material and Finish	
UBA-4R-S14-4S	Contact	Copper alloy, nickel-undercoated, selective gold-plated
	Housing	Thermoplastic resin, UL94V-0
	Shell	Copper alloy, nickel-undercoated, tin-plated

RoHS compliance This product displays (LF)(SN) on a label.

Model No.	Material and Finish	
UBA-4R-S14A-4S	Contact	Copper alloy, nickel-undercoated, selective gold-plated
	Housing	Thermoplastic resin, UL94V-0
	Shell	Copper alloy, nickel-undercoated, tin-plated

RoHS compliance This product displays (LF)(SN) on a label.

Model No.	Material and Finish	
UBA-4R-S14B-4S	Contact	Copper alloy, nickel-undercoated, selective gold-plated
	Housing	Thermoplastic resin, UL94V-0
	Shell	Copper alloy, nickel-undercoated, tin-plated

RoHS compliance This product displays (LF)(SN) on a label.

Type A <SMT type> With upper flange

TID No.: 60000174

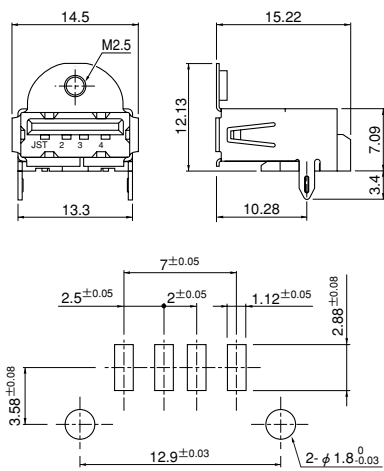

Q'ty/box: 216

Type A <SMT type> FULL SMT

TID No.: 60000434

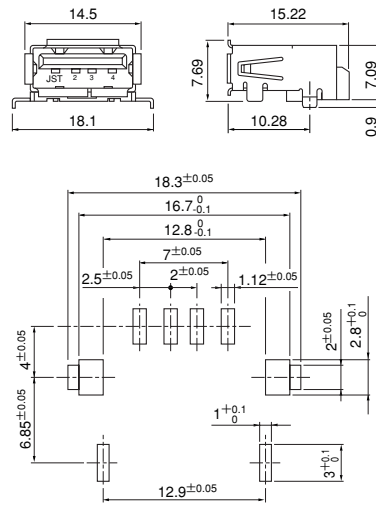

Q'ty/box: 192

Type A <SMT type> Reverse

TID No.: 62000434

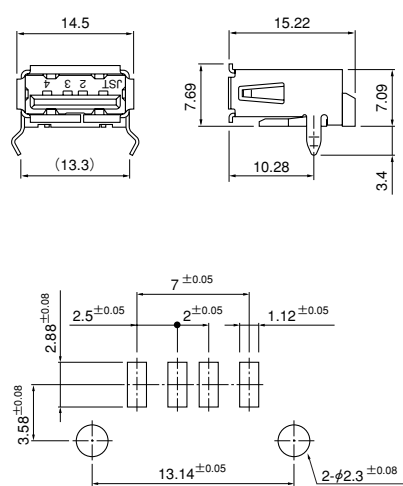

Q'ty/box: 250

Model No.	Material and Finish	
UBA-4R-S14C-4S	Contact	Copper alloy, nickel-undercoated, selective gold-plated
	Housing	Thermoplastic resin, UL94V-0
	Shell	Copper alloy, nickel-undercoated, tin-plated

RoHS compliance This product displays (LF)(SN) on a label.

Model No.	Material and Finish	
UBA-4R-S14HD-4S	Contact	Copper alloy, nickel-undercoated, selective gold-plated
	Housing	Thermoplastic resin, UL94V-0
	Shell	Copper alloy, nickel-undercoated, tin-plated

RoHS compliance This product displays (LF)(SN) on a label.

Model No.	Material and Finish	
UBA-4R-S14-4S	Contact	Copper alloy, nickel-undercoated, selective gold-plated
	Housing	Thermoplastic resin, UL94V-0
	Shell	Copper alloy, nickel-undercoated, tin-plated

RoHS compliance This product displays (LF)(SN) on a label.

Note: 1. The dimensions above should serve as a guideline. Contact JST for details.

2. Thin gold-plated (Au Flash) product that is USB 2.0 uncertified product (** 10) is also available.

Receptacle

USB 2.0 certified product

**Type B <Through-hole type>
With solder tab**
TID No.: 60000457

Q'ty/box: 270

**Type B <Through-hole type>
With upper flange**
TID No.: 60000457

Q'ty/box: 270

**Type B <Through-hole type>
Straight**
TID No.: 60000468

Q'ty/box: 600

Model No.	Material and Finish
UBB-4R-D14T-4D	Contact Copper alloy, nickel-undercoated, selective gold-plated
	Housing Thermoplastic resin, UL94V-0
	Shell Copper alloy, nickel-undercoated, tin-plated

RoHS compliance This product displays (LF)(SN) on a label.
 Note: 1. The dimensions above should serve as a guideline. Contact JST for details.
 2. Thin gold-plated (Au Flash) product that is USB 2.0 uncertified product (** 10) is also available.

Model No.	Material and Finish
UBB-4R-D14C-4D	Contact Copper alloy, nickel-undercoated, selective gold-plated
	Housing Thermoplastic resin, UL94V-0
	Shell Copper alloy, nickel-undercoated, tin-plated

RoHS compliance This product displays (LF)(SN) on a label.
 Note: 1. The dimensions above should serve as a guideline. Contact JST for details.
 2. Thin gold-plated (Au Flash) product that is USB 2.0 uncertified product (** 10) is also available.

Model No.	Material and Finish
UBBS-4R-D14-4D	Contact Copper alloy, nickel-undercoated, selective gold-plated
	Housing Thermoplastic resin, UL94V-0
	Shell Copper alloy, nickel-undercoated, tin-plated

RoHS compliance This product displays (LF)(SN) on a label.
 Note: 1. The dimensions above should serve as a guideline. Contact JST for details.
 2. Thin gold-plated (Au Flash) product that is USB 2.0 uncertified product (** 10) is also available.

Plug type A SMT type

USB 2.0 certified product

TID No.: 61001068

Q'ty/box: 5,580

Model No.	Material and Finish
UBA-4P-S14E	Contact Copper alloy, nickel-undercoated, selective gold-plated
	Housing Heat resisting resin, UL94V-0
	Shell Copper alloy, nickel-undercoated, palladium-plated

RoHS compliance This product displays (LF)(SN) on a label.
 Note: 1. Not UL/CSA approved.
 2. The dimensions left should serve as a guideline. Contact JST for details.
 3. Thin gold-plated (Au Flash) product that is USB 2.0 uncertified product (** 10) is also available.