

# 0RCP-D4T12x

## Isolated DC-DC Converter

The 0RCP-D4T12x is an isolated DC/DC converter that operates from a nominal 48 V source. This unit provides up to 240 W of output power from a nominal 48 V input.

This unit is designed to be highly efficient and low cost. Features include remote on/off, short circuit protection, over current protection, undervoltage lockout and over-temperature protection, pre-bias startup and Power Management Bus communication.

The converter is provided in an industry standard eighth brick package.

### Key Features & Benefits

- 48 VDC Input
- 12 VDC @ 20 A Output
- 1/8<sup>th</sup> Brick Converter
- Basic Isolation
- High Efficiency
- High Power Density
- Power Management Bus Rev1.3 compliance
- Input Under Voltage Lockout
- Output Over-Voltage Protection
- OCP/SCP
- Over Temperature Protection
- Low Cost
- Remote On/Off
- Approved to UL/CSA/IEC 62368-1 (TBD)
- Class II, Category 2, Isolated DC/DC Converter (refer to IPC-9592B)

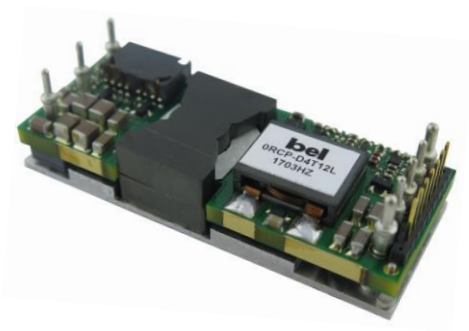

### Applications

- Industrial
- Computers and Peripherals
- Telecommunications

## 1. MODEL SELECTION

MODEL NUMBER	OUTPUT VOLTAGE	INPUT VOLTAGE	MAX. OUTPUT CURRENT	MAX. OUTPUT POWER	TYPICAL EFFICIENCY
ORCP-D4T12L	12 VDC	48 VDC	20 A	240 W	95.4%
ORCP-D4T120	12 VDC	48 VDC	20 A	240 W	95.4%
ORCP-D4T12A	12 VDC	48 VDC	20 A	240 W	95.4%
ORCP-D4T12B	12 VDC	48 VDC	20 A	240 W	95.4%

**NOTE:** Add "G" suffix at the end of the model number to indicate packaging.

### PART NUMBER EXPLANATION

0	R	CP	-	D4	T	12	x	G
Mounting Type	RoHS Status	Series Name		Output Power	Input Range	Output Voltage	Logic and Optional Features	Package Type
Through hole mount	RoHS	1/8 <sup>th</sup> Brick		240 W	48 V	12 V	0 – Active high, with baseplate, Pin length = 0.18 inch L – Active low, with baseplate, Pin length = 0.18 inch A – Active high, with baseplate, Pin length = 0.145 inch B – Active low, with baseplate, Pin length = 0.145 inch	G – Tray package

## 2. ABSOLUTE MAXIMUM RATINGS

PARAMETER	DESCRIPTION	MIN	TYP	MAX	UNITS
Input Voltage		-0.3	-	80	V
Input Transient Voltage	100 ms maximum	-	-	100	V
Remote On/Off		-0.3	-	16	V
Logic Pin Voltage (to SIG_GND or Vo-)		-0.3	-	3.6	V
I/O Isolation Voltage		-	-	1500	V
Ambient Temperature		-40	-	85	°C
Storage Temperature		-55	-	125	°C
Altitude		-	-	2000	m

**NOTE:** Ratings used beyond the maximum ratings may cause a reliability degradation of the converter or may permanently damage the device.

### 3. INPUT SPECIFICATIONS

All specifications are typical at 25°C unless otherwise stated.

PARAMETER	DESCRIPTION	MIN	TYP	MAX	UNIT
Operating Input Voltage		36	48	75	V
Input Current (full load)	at 36 VDC	-	-	7.5	A
Input Current (no load)		-	50	100	mA
Remote Off Input Current		-	3	6	mA
Input Reflected Ripple Current is (rms)	With simulated source impedance of 10 $\mu$ H, 5 Hz to 20 MHz. Use a 100 $\mu$ F/100 V electrolytic capacitor with ESR=1 ohm max, at 200 KHz @ 25°C.	-	3	-	mA
Input Reflected Ripple Current is (pk-pk)		-	20	-	mA
I <sup>2</sup> t Inrush Current Transient		-	-	1	A <sup>2</sup> s
Under-voltage Turn on Threshold		-	34.5	36	V
Under-voltage Turn off Threshold		31	32.5	-	V

**CAUTION: This converter is not internally fused. An input line fuse must be used in application. Recommended input fast-acting fuse on system board.**

### 4. OUTPUT SPECIFICATIONS

All specifications are typical at nominal input, full load at 25°C unless otherwise stated.

PARAMETER	DESCRIPTION	MIN	TYP	MAX	UNIT
Output Voltage Set Point	Vin=48V, Io=50% load at 25C ambient.	11.880	12.000	12.120	V
Load Regulation	Vin=36-40V, Io=0~100% load at 25C ambient.	-	200	-	mV
	Vin=40-75V, Io=0~100% load at 25C ambient.	-	10	-	mV
Line Regulation	Vin=36-40V, Io=100% load at 25C ambient. See Typical Output Voltage Regulation vs. Input Voltage at 25C ambient.	-	-	-	mV
	Vin=40-75V, Io=100% load at 25C ambient.	-	24	-	mV
Regulation Over Temperature (-40deg.C-85deg.C)	Vin=36-40V, Io=100% load	-	250	-	mV
	Vin=40-75V, Io=100% load	-	140	-	mV
Output Ripple and Noise (pk-pk)	Vin=48V, Io=100% load at 25C ambient.	-	55	100	mV
Output Ripple and Noise (rms)	0-20MHz BW, with a 1 $\mu$ F ceramic capacitor, a 10 $\mu$ F Tantalum cap and a 270 $\mu$ F Oscon cap at output.	-	10	-	mV
Output Ripple and Noise (pk-pk) under worst case	over all operating input voltage, load and ambient temperature condition	-	150	-	mV
Output Current Range		0	-	20	A
Output DC Current Limit		-	26	-	A
Short Circuit Surge Transient		-	-	5	A <sup>2</sup> s
Rise time		-	20	35	
Turn-On Time	Enable form Vin	-	40	70	ms
	Enable form ON/OFF	-	40	70	ms
Overshoot at Turn on		-	0	3	%
Output Capacitance		270	-	10000	$\mu$ F
<b>Transient Response</b>					
$\Delta$ V 75%~50% of Max Load		-	300	-	mV
Settling Time	di/dt=0.1A/ $\mu$ s, Vin=48Vdc, Ta=25°C, with a 1 $\mu$ F ceramic capacitor, a 10 $\mu$ F Tantalum cap and a 270 $\mu$ F Oscon cap at output.	-	200	-	us
$\Delta$ V 50%~75% of Max Load		-	300	-	mV
Settling Time		-	200	-	us



Asia-Pacific  
+86 755 298 85888

Europe, Middle East  
+353 61 225 977

North America  
+1 408 785 5200

## 5. GENERAL SPECIFICATIONS

PARAMETER	DESCRIPTION	MIN	TYP	MAX	UNIT
Efficiency (Vin =48V; Io=Io, max)	The efficiency is measured at Vin=48V, full load and Ta=25°C.	-	95.4	-	%
Switching Frequency		-	150	-	kHz
FIT <sup>2</sup>	Calculated Per Telcordia SR-332, Issue 3 (Vin=48 V, Vo=12 V, Io=16 A, Ta = 25°C, FIT <sup>2</sup> =10 <sup>9</sup> /MTBF)	-	189	-	
Over Temperature Protection		-	130	-	°C
Weight		-	38.5	-	g
Dimensions					
Inches (L x W x H)			2.30 x 0.90 x 0.50		INCH
Millimeters (L x W x H)			58.42 x 22.86 x 12.7		mm
Isolation Characteristics					
Input to Output		-	-	1500	V
Isolation Resistance		10M	-	-	Ohm
Isolation Capacitance		-	1000	-	pF

**Notes:** All specifications are typical at 25 °C unless otherwise stated.

## 6. EFFICIENCY DATA

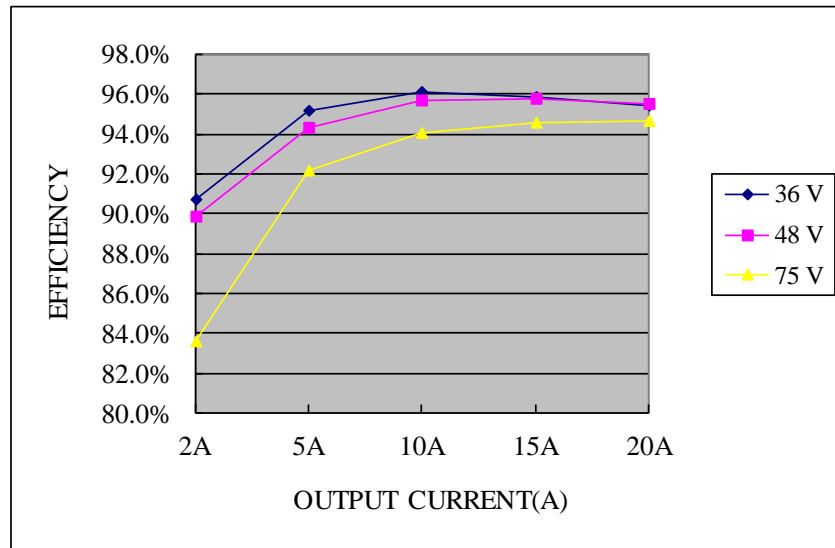

Figure 1. Efficiency data

**7. THERMAL DEARTING CURVES**

New high power architectures require an accurate thermal design. Design engineers have to optimize the module working conditions and ensure reliable operation. Convection cooling is the common mode to cool down the module. Heat transfer is dependent on a test setup and it is important to characterize the module in an environment similar to existent electronic applications. Reported thermal data reflects real operating conditions because the values are physically measured in a wind tunnel.

**Thermal test setup**

A module in electronic cards is typically located in a busy area without relevant space around it. To simulate a real condition and avoid turbulence we add a cover with defined dimensions. The distance has to be 6.35mm (0.25"inch) from the top of the module and 6.35mm (0.25"inch) on the left and right side of the module. The values reflect most of the real applications and it is a common procedure in the power module market. Ambient temperature and airflow are measured in front of the module at the distance of 76.2mm (3"inch).

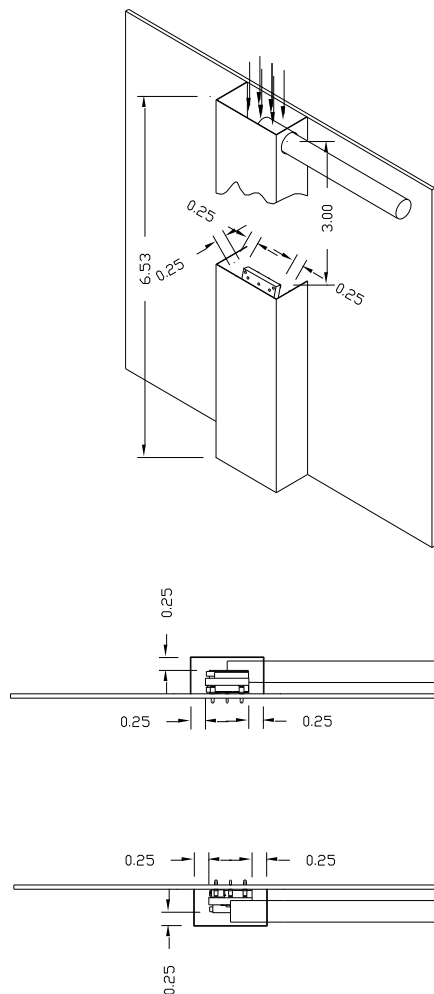

Figure 2. Thermal test setup

**THERMAL DEARTING CURES(CONTINUED)**

Maximum junction temperature of semiconductors derated to 120 degree C.

The OTP is achieved by temperature sensor U10 and it's in non-latch mode when the hottest component Q7 reaches 118°C with 200LFM air flow correspondingly. It will restart automatically when the temperature falls down to 105°C. The protecting point will be varied a little under different conditions (air flow, ambient temperature, input voltage, load...).

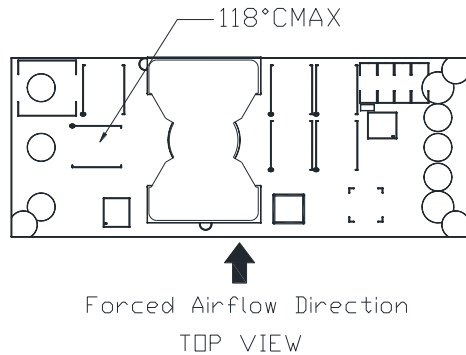

Figure 3. Airflow direction

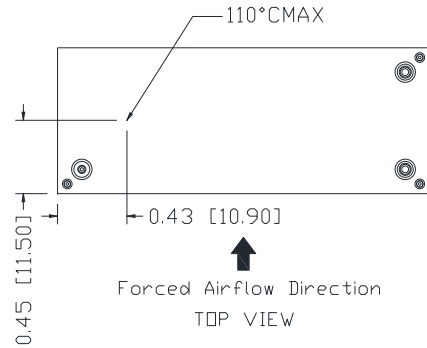

Figure 4. Hot spot

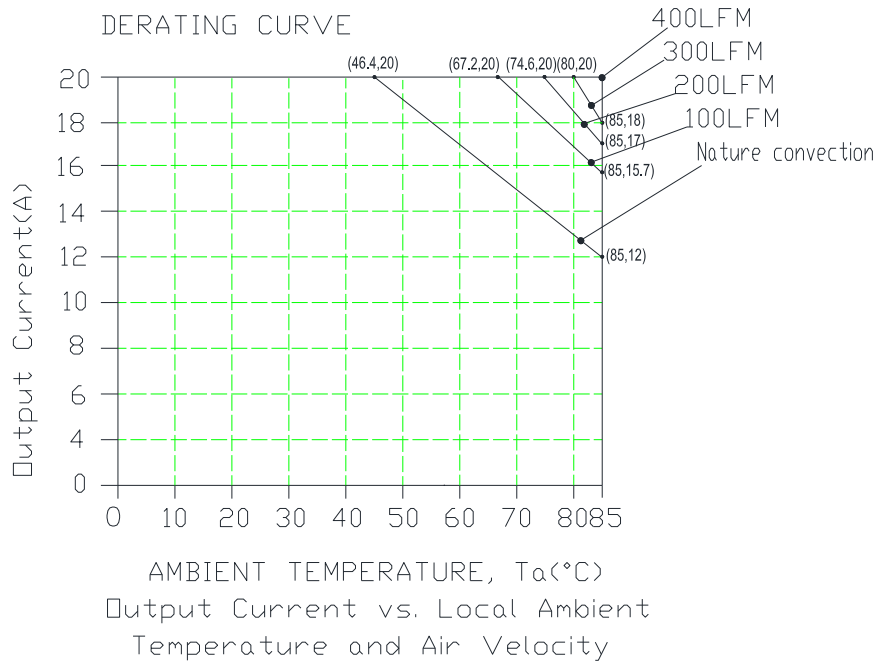

Figure 5. Derating curve

## 8. REMOTE ON/OFF

PARAMETER		DESCRIPTION	MIN	TYP	MAX	UNIT
Signal Low (Unit On)	Active Low	0RCY-D4T12L/0RCY-D4T12B The remote on/off pin open, Unit off.	-0.3	-	0.8	V
Signal High (Unit Off)			2	-	16	V
Signal Low (Unit Off)	Active High	0RCY-D4T120/0RCY-D4T12A The remote on/off pin open, Unit on.	-0.3	-	0.8	V
Signal High (Unit On)			2	-	16	V
Current Sink			0	-	1	mA

Recommended remote on/off circuit for active low

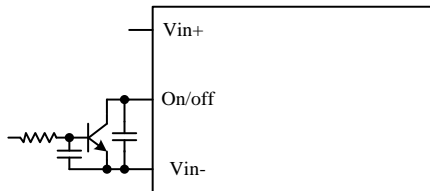

Figure 6. Control with open collector/drain circuit

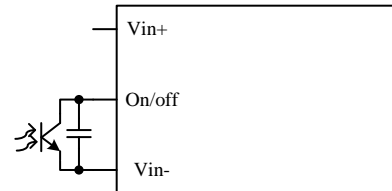

Figure 7. Control with photocoupler circuit

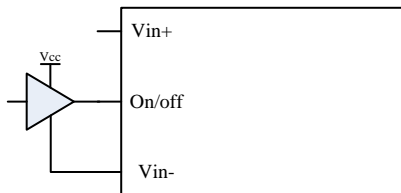

Figure 8. Control with logic circuit

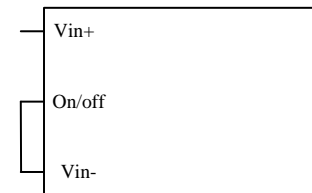

Figure 9. Permanently on

Recommended remote on/off circuit for active high

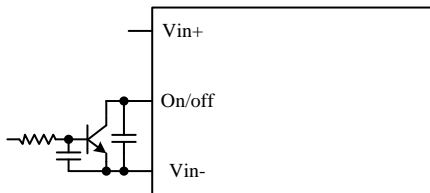

Figure 10. Control with open collector/drain circuit

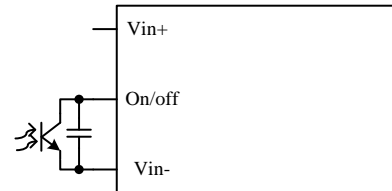

Figure 11. Control with photocoupler circuit

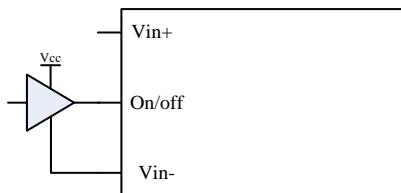

Figure 12. Control with logic circuit

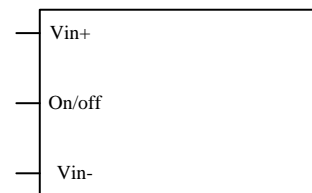

Figure 13. Permanently on

9. RIPPLE AND NOISE WAVEFORM

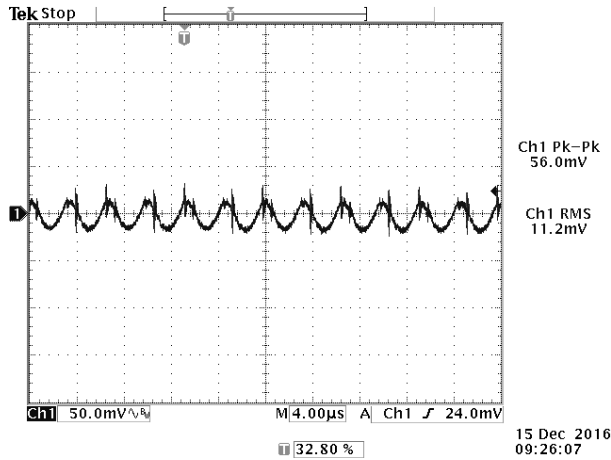

Figure 14. Ripple and noise waveform

Note: Ripple and noise at full load, 48Vdc input, 12Vdc/20A output and Ta=25 deg C. and with a 1uF ceramic cap and a 270 uF Tantalum cap at output.

10. TRANSIENT RESPONSE WAVEFORMS

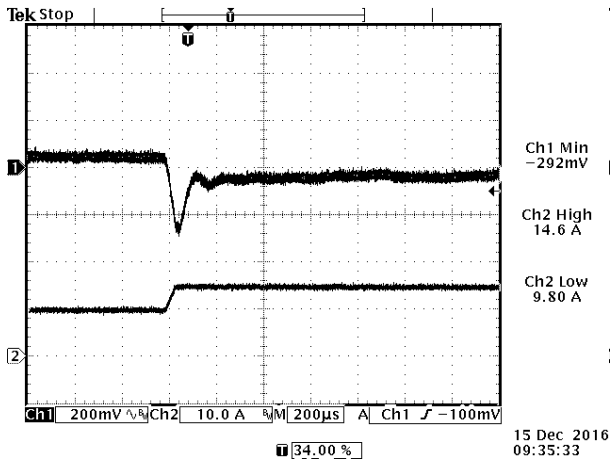

Figure 15.

Vout= 12V 50%-75% Load Transients at Vin=48V@Ta=25°C

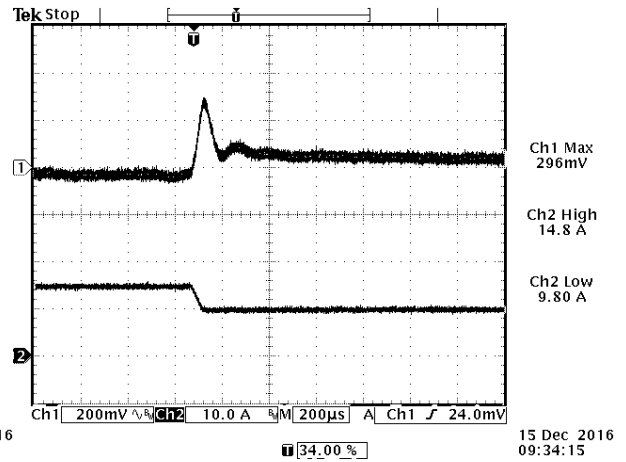

Figure 16.

Vout= 12V 75%-50% Load Transients at Vin=48V@Ta=25°C



## 11. STARTUP & SHUTDOWN

### Rise time

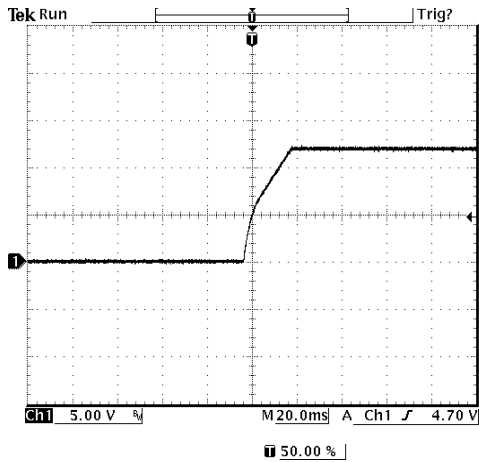

17 Jan 2017 10:29:22

Figure 17.

**Test Condition:**  $V_{out}=12V/20A$  at  $V_{in}=48V@T_a=25^\circ C$   
 $C_{ext}=270\mu F$

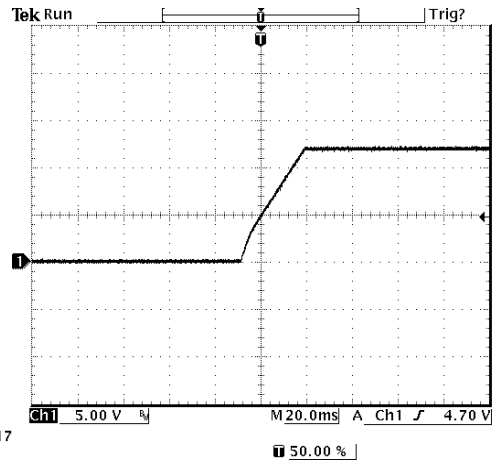

17 Jan 2017 10:30:41

Figure 18.

**Test Condition:**  $V_{out}=12V/20A$  at  $V_{in}=48V@T_a=25^\circ C$   
 $C_{ext}=10000\mu F$

### Startup time

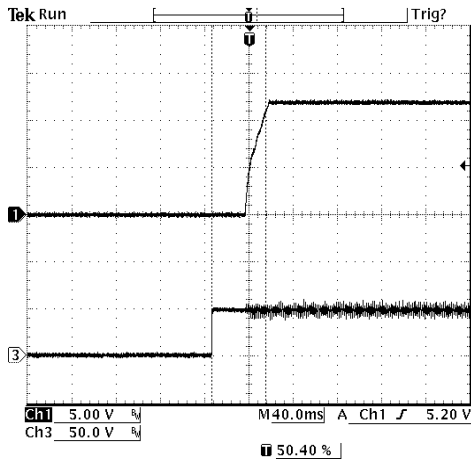

17 Jan 2017 10:49:41

Figure 19.  
 Startup from  $V_{in}$   
 Ch1:  $V_o$   
 Ch2:  $V_{in}$

**Test Condition:**  $V_{out}=12V/20A$  at  $V_{in}=48V@T_a=25^\circ C$

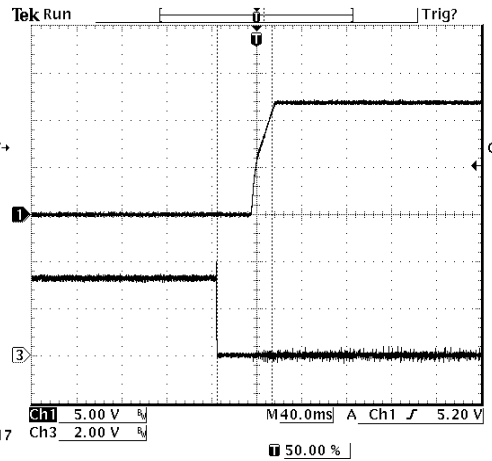

17 Jan 2017 10:37:34

Figure 20.  
 Startup from on/off  
 Ch1:  $V_o$   
 Ch2: on/off

**Test Condition:**  $V_{out}=12V/20A$  at  $V_{in}=48V@T_a=25^\circ C$

**STARTUP & SHUTDOWN(CONTINUED)**

**Shutdown**

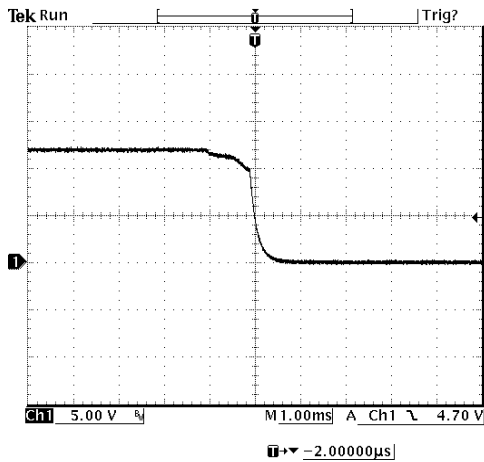

Figure 21.  
Startup from Vin  
Ch1: Vo

**Test Condition:** Vout= 12V/20A at Vin=48V@Ta=25°C

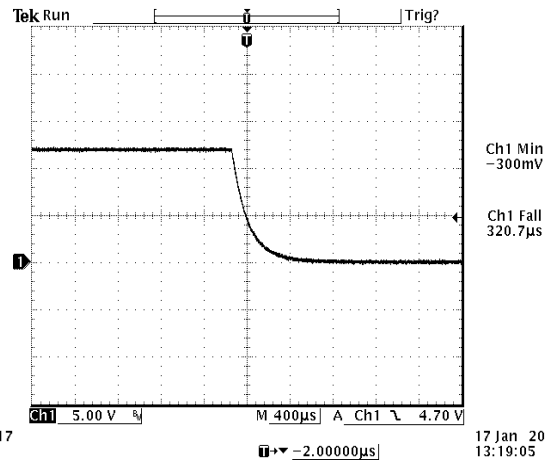

Figure 22.  
Startup from on/off  
Ch1: Vo

**Test Condition:** Vout= 12V/20A at Vin=48V@Ta=25°C

**12. OVERCURRENT PROTECTION**

To provide protection in a fault output overload condition, the module is equipped with internal over current protection circuitry . If the overcurrent condition occurs, the module will shut down into hiccup mode and restart once every 250 ms. The module operates normally when the output current goes into specified range.

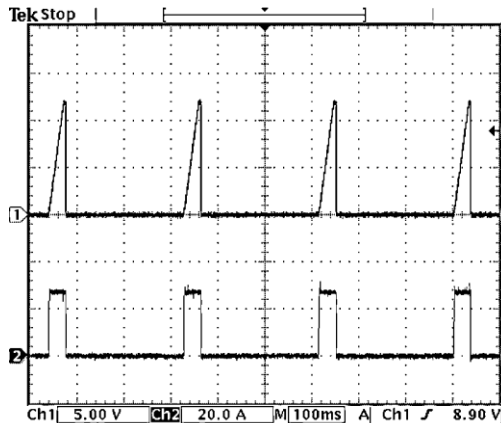

Figure 23.  
Test condition: Vin=48V@Ta=25°C

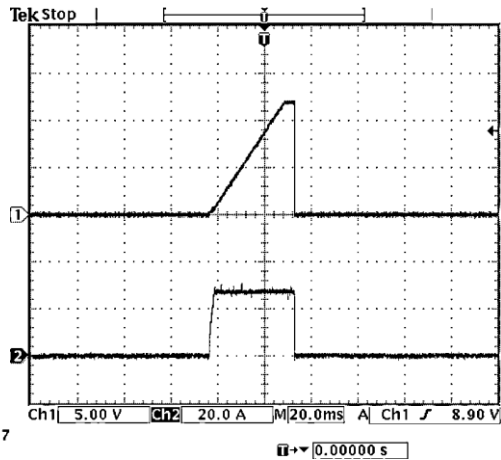

Figure 24.  
Expansion of on time portion of above figure  
CH1: Output Voltage  
CH2: Output current waveform

**13. TYPICAL OUTPUT VOLTAGE REGULATION**

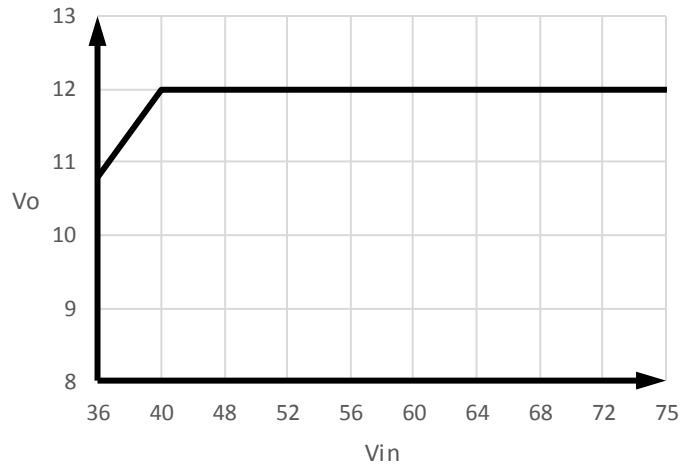

Figure 25.  
Typical Output Voltage Regulation vs. Input Voltage at 25C ambient

**14. INPUT UNDER-VOLTAGE LOCKOUT**

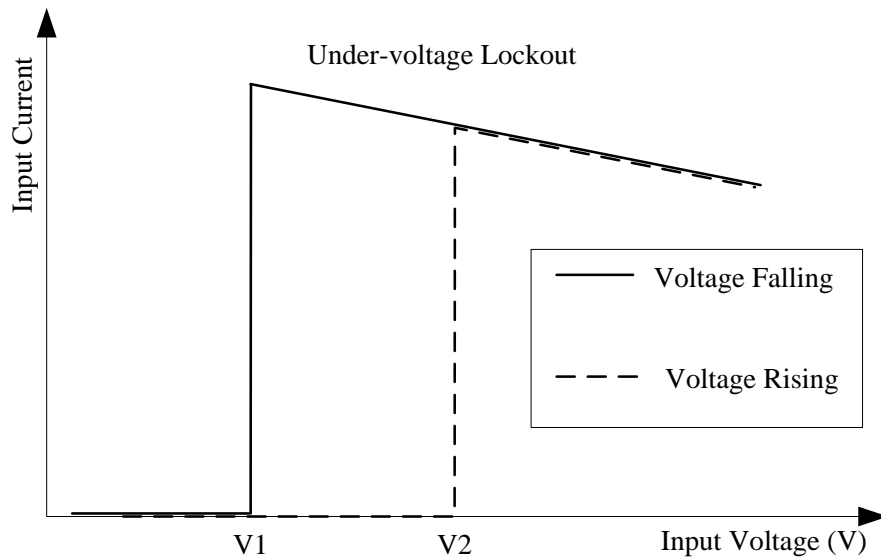

Figure 26. Input under-voltage lockout

V1=32.5V

V2=34.5V

**15. OUTPUT TRIM EQUATIONS**

Equations for calculating the trim resistor are shown below. The Trim Down resistor should be connected between the Trim pin and Sense (-) pin. The Trim Up resistor should be connected between the Trim pin and the Sense (+). Only one of the resistors should be used for any given application.

Minimum trim down voltage is 13.2V. (Trim up at Vin>44V)

Maximum trim up voltage is 9.6V

The total voltage increased by trim and remote sense should not exceed 5% of the nominal output voltage.

**Trim down test circuit**

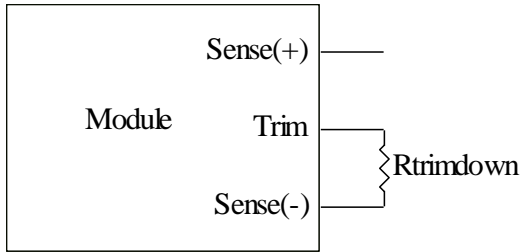

Figure 27. Trim down test circuit

$$R_{trimdown} = \frac{511}{|\delta|} - 10.22 [k\Omega]$$

**Trim up test circuit**

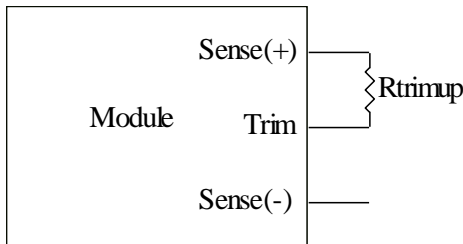

Figure 29. Trim up test circuit

$$R_{trimup} = \frac{(100 + \delta) \cdot V_o \cdot 5.11 - 626}{1.225 \cdot \delta} - 10.22 [k\Omega]$$

**Note:**

$$\delta = \frac{(V_{o\_req} - V_o)}{V_o} \times 100 [\%]$$

V<sub>o\_req</sub>=Desired (trimmed) output voltage [V]

Output voltage V<sub>o</sub>=12 V.

**Note:** 1. The trim used the VOUT\_COMMAND of POWER MANAGEMENT BUS and the trim used the function of trim pin(6 pin) cannot be used at the same time.

2. If use VOUT\_COMMAND of POWER MANAGEMENT BUS to trim Vout set point, then the function of trim pin(6 pin) will be disabled immediately. And if need enable the function of trim pin(6pin) to trim Vout set point again, should turn off and turn on the input voltage of module to restart module.

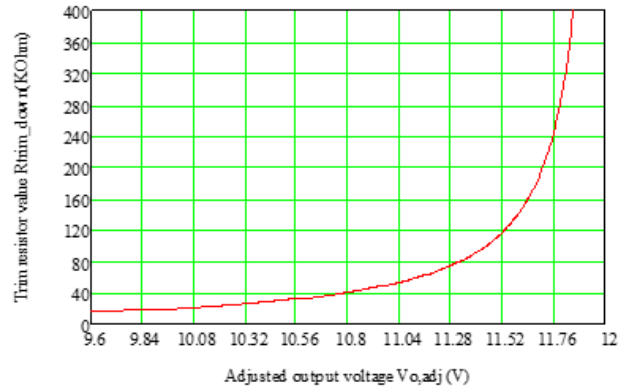

Figure 28. Trim down curve

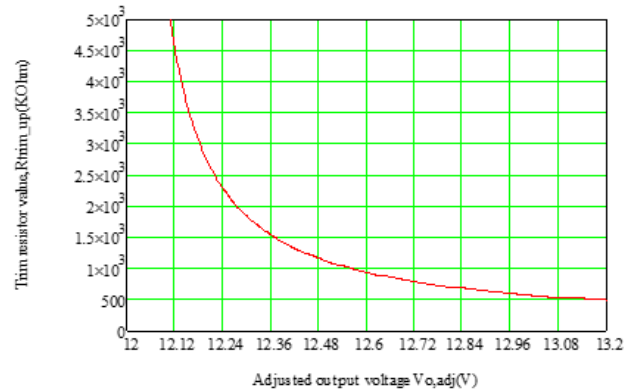

Figure 30. Trim up curve

## 16. SAFETY & EMC

**Safety:** TBD

**EMC:** 1. Conductive EMI: EN55022 class A

Compliance to EN55022 class A (both q.peak and average) with the following inductive and capacitive filter

**Setup:**

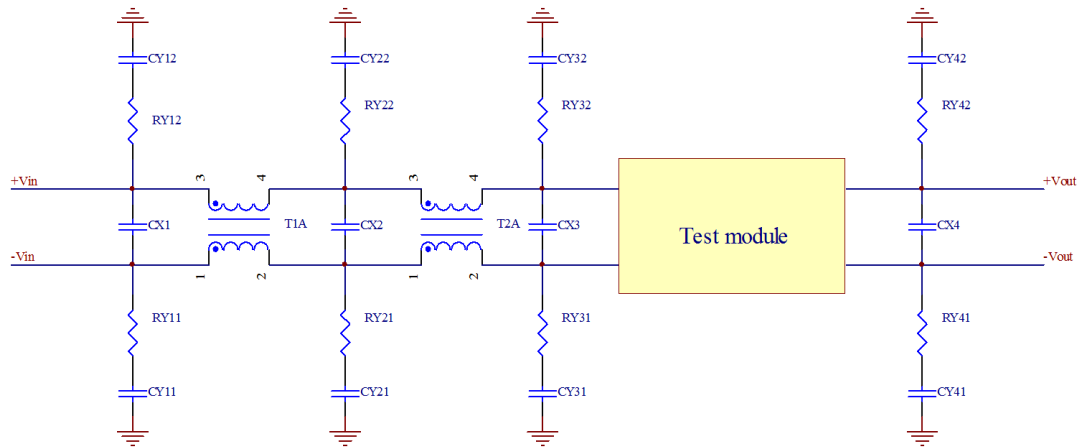

Figure 31.

ITEM	DESIGNATOR	PARAMETER
1	CX2	1uF/100V,1206, ceramic
2	CX3	1uF/100V,1206, ceramic 220uF/100V, AL cap 100uF/100V, AL cap 1/16V, 0805, ceramic
3	CX4	10uF/16V, case B,Tantalum 270uF/16V,Oscon
4	CY31	2200pF/500V, Y1
5	CY32	2200pF/500V, Y1
6	RY31	0Ω,1206, Resistor
7	RY32	0Ω,1206, Resistor
8	T2A	970uH, common mode
9	T1A,CX1,CX2,RY11,RY21,RY12, RY22,RY41,YR42,CY11,CY21,CY12, CY22,CY41,CY42	NIL

**SAFETY&EMC(CONTINUED)**

Positive:

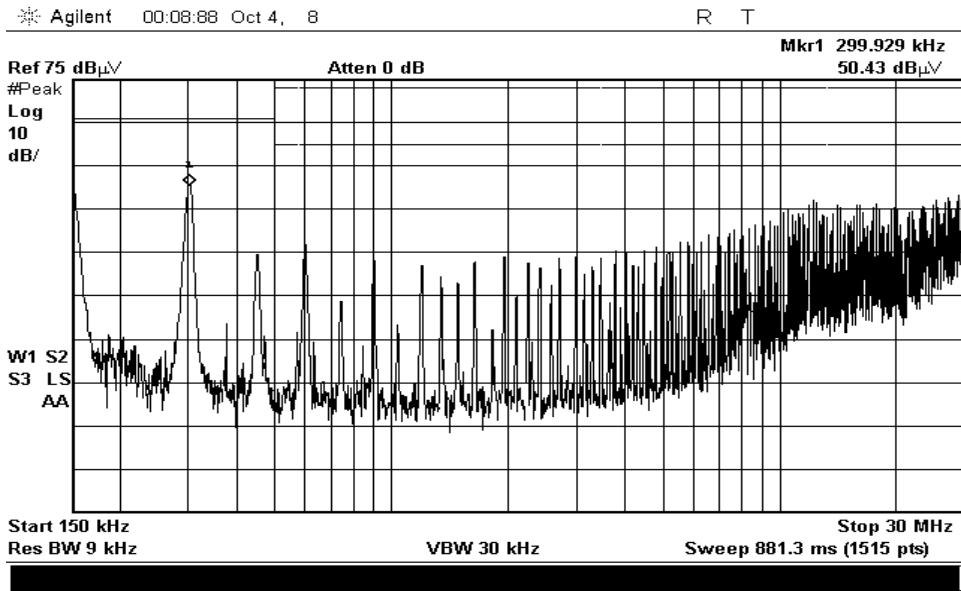

Figure 32.

Negative:

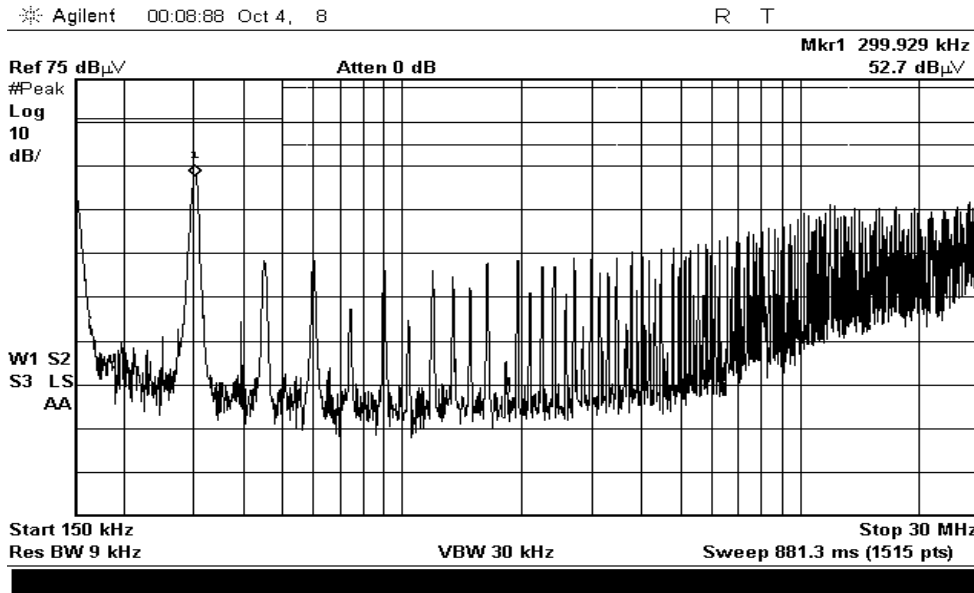

Figure 33.

**17. POWER MANAGEMENT BUS**

**Power Management Bus Digital Feature Description**

The module supports Power Management Bus to allow to be monitored, controlled and configured by the system. More detailed Power Management Bus information can be found in the Power Management Bus Power Management Protocol Specification, Part I and part II, revision 1.3, which is shown in the System Management Interface Forum Web site: [www.powerSIG.org](http://www.powerSIG.org). The supported Power Management Bus commands of the module are listed below in the supported POWER MANAGEMENT BUS COMMANDS section. The module supports four Power Management Bus signal lines: Data, Clock, SMBALERT (optional), Control (C2 pin, optional), and two Address lines: Addr0 and Addr1.

SMBALERT protocol is also supported by the module. SMBALERT line is also a wired-AND signal, by which the module can alert the POWER MANAGEMENT BUS master via pulling the SMBALERT pin to an active low. There is only one way that the master and the module response to the alert of SMBALERT line. The master will communicate with the slave module using the programmed address, and using the various READ\_STATUS commands to find the cause for the SMBALERT. The CLEAR\_FAULTS command will clear the SMBALERT.

The module contains a data flash used to store configuration settings, which will not be programmed into the device data flash automatically. The STORE\_DEFAULT\_ALL can be used to store the current settings to the non-volatile memory. The RESTORE\_DEFAULT\_ALL can be used to restore the factory settings to the non-volatile memory.

**Power Management Bus Addressing**

The Module has flexible Power Management Bus addressing capability. When connect different resistor from Addr0 and Addr1 pin to GND pin, 64 possible addresses can be acquired. The address is in the form of octal digits; Each pin offers one octal digit, and then combine together to form the decimal address as shown in below.

$$\text{Address} = 8 * \text{ADDR1} + \text{ADDR0}$$

Corresponded to each octal digit, the requested resistor values are shown below, and +/-1% resistors accuracy can be accepted. If there are any resistances exceeding the requested range, address 64 will be return. 0-12 and 40, 44, 45, and 55 in decimal address cannot be used, since they are reserved according to the Power Management Bus specifications, and which will also return address 64.

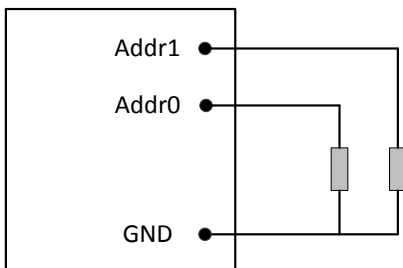

Octal Digit	Resistor (Kohm)
0	10
1	15.4
2	23.7
3	36.5
4	54.9
5	84.5
6	130
7	200

NOTE: Power Management Bus communication is only supported when vin normal and remote on.



Asia-Pacific  
+86 755 298 85888

Europe, Middle East  
+353 61 225 977

North America  
+1 408 785 5200

**POWER MANAGEMENT BUS(CONTINUED)**

**Power Management Bus Data Format**

For commands which is except to the output voltage, including input voltage, output current, temperature, PWM frequency, duty cycle, the controller will use the 2-byte linear format as defined by the Power Management Bus system management protocol. The linear data format contains 2 bytes which include a 5-bit two's complement exponent and an 11-bit two's complement mantissa as below. The transmitted value Y is reported as the form  $Y = X \cdot 2^N$ .

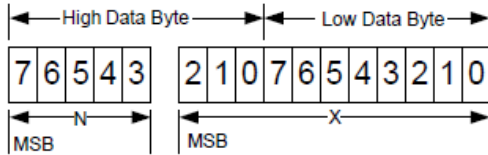

For example, to set the over temperature fault threshold 135 deg C by OT\_FAULT\_LIMIT command, the read/write data can be calculated refer to below: the binary number of N is 0, whose decimal number is 0.

$X = \text{TOTP}/2(0) = 135$ , whose binary is 0b00010000111.

Combine X and N, the binary is 0b0000000010000111. The hexadecimal of OT\_FAULT\_LIMIT is 0x0087.

The output voltage parameters use the Power Management Bus Vout linear format. The data format is shown below.

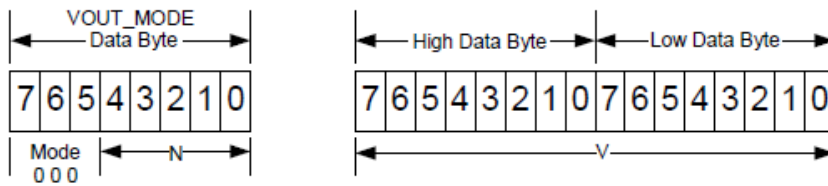

The voltage will be in the form  $\text{Voltage} = V \cdot 2^N$ . The Mantissa and exponent in this equation will be read and reported using 3 bytes. The first byte is the VOUT\_MODE byte which will always contain 000 in the 3 MSB's. The 5 LSB's are the exponent. The exponent N is fixed and equals -10. The other 2 bytes N will contain the Mantissa. In the above format N is a 5-bit two's complement binary integer and V is a 16-bit unsigned binary integer. All 16 bits are reported to be compatible with the Power Management Bus protocol.

For example, to set Vout to 10.8V by VOUT\_COMMAND, the read/write data can be calculated refer to below process:

$$V = \text{Vout}/2(-10) = 10.8/2(-10) \approx 11059$$

Convert the decimal to hexadecimal format is 0x2B33. So the VOUT\_COMMAND is 0x2B33.



**POWER MANAGEMENT BUS(CONTINUED)****Supported Power Management Bus Commands**

The main Power Management Bus commands described in the Power Management Bus 1.3 specification are supported by the module. Partial Power Management Bus commands are fully supported; Partial Power Management Bus commands have difference with the definition in Power Management Bus 1.3 specification. All the supported Power Management Bus commands are detailed summarized in the below table.

Command	Comm and code	Command Description	Type	Standard or not	Data format	Default value	Range Limit	Data units	Exponent	Note
OPERATION	0x01	Configures the operational state of the module	R/W byte	Refer to description	Bit field	0x80	/	/	/	/
ON_OFF_CONFIG	0x02	Configures the combination of CONTROL pin input and serial bus commands needed to turn the module on and off	Read byte	Refer to description	Bit field	0x18	/	/	/	OPERATION command controls module on/off
STORE_DEFAULT_ALL	0x11	Store the current settings to the non-volatile memory	W and no data bytes	Standard	/	/	/	/	/	/
RESTORE_DEFAULT_ALL	0x12	Restore the factory settings to the non-volatile memory	W and no data bytes	Standard	/	/	/	/	/	/
VOUT_MODE	0x20	Read Vo data format	Read byte	Standard and refer to Power Management Bus data format	mode + exponent	0x16	/	/	/	/
VOUT_COMMAND	0x21	Set the output voltage normal value	R/W word	Standard and refer to Power Management Bus data format	Vout linear	12	9.6-13.2	Volts	-10	/
VOUT_MAX	0x24	Set a upper limit on the output voltage the module can command	Read word	Standard and refer to Power Management Bus data format	Vout linear	13.2	/	Volts	-10	/
VOUT_MARGIN_HIGH	0x25	Set the output voltage margin high value	R/W word	Standard and refer to Power Management Bus data format	Vout linear	12.6	<13	Volts	-10	/
VOUT_MARGIN_LOW	0x26	Set the output voltage margin low value	R/W word	Standard and refer to Power Management Bus data format	Vout linear	11.4	>10.2	Volts	-10	/
VOUT_MIN	0x2B	Set a lower limit on the output voltage the module can command	Read word	Standard and refer to Power Management Bus data format	Vout linear	9.6	/	Volts	-10	/
MAX_DUTY	0x32	Set the maximum duty cycle	R/W word	Standard and refer to Power Management Bus data format	Linear	50	40-50	%	0	/
FREQUENCY_SWITCH	0x33	Set the switching frequency	R/W word	Standard and refer to Power Management Bus data format	Linear	150	140-175	kHz	0	The switching frequency updated at the next Vin power on
VOUT_OV_FAULT_LIMIT	0x40	Set the output overvoltage fault threshold	R/W word	Standard and refer to Power Management Bus data format	Vout linear	13.5	11-16	Volts	-10	Must be higher than the value of VOUT_COMMAND
VOUT_OV_FAULT_RESPONSE	0x41	Instructs what action to take in response to an output overvoltage fault	R/W byte	Refer to description	Bit field	0xB8	/	/	/	/
IOUT_OC_FAULT_LIMIT	0x46	Set the output overcurrent fault threshold	R/W word	Standard and refer to Power Management Bus data format	Linear	25	22-27	A	0	/
IOUT_OC_FAULT_RESPONSE	0x47	Instructs what action to take in response to an output overcurrent fault	R/W byte	Refer to description	Bit field	0xF8	/	/	/	/
IOUT_OC_WARN_LIMIT	0x4A	Set a threshold causing an output current high warning	R/W word	Standard and refer to Power Management Bus data format	Linear	24	22-27	A	0	Must less than IOUT_OC_FAULT_LIMIT value
OT_FAULT_LIMIT	0x4F	Set the over temperature fault threshold	R/W word	Standard and refer to Power	Linear	130	25-140	Dec C	0	/

				Management Bus data format						
OT_FAULT_RESP ONSE	0x50	Instructs what action to take in response to an over temperature fault	R/W byte	Refer to description	Bit field	0xB8	/	/	/	/
OT_WARN_LIMIT	0x51	Set a threshold causing a temperature high warning	R/W word	Standard and refer to Power Management Bus data format	Linear	125	25-140	Dec C	0	Must less than OT_FAULT_LIMIT value
VIN_OV_FAULT_LI MIT	0x55	Set the input overvoltage fault threshold	Read word	Standard and refer to Power Management Bus data format	Linear	80	/	Volts	-3	Realized by hardware
VIN_UV_FAULT_LI MIT	0x59	Set the input undervoltage fault threshold	Read word	Standard and refer to Power Management Bus data format	Linear	33	/	Volts	-3	Realized by hardware
STATUS_WORD	0x79	Returns the information with a summary of the unit's fault/warn condition	Read word	Refer to description	Bit field	/	/	/	/	/
STATUS_VOUT	0x7A	Returns the information with a summary of the unit's output voltage condition	Read byte	Refer to description	Bit field	/	/	/	/	/
STATUS_IOUT	0x7B	Returns the information with a summary of the unit's output current condition	Read byte	Refer to description	Bit field	/	/	/	/	/
STATUS_INPUT	0x7C	Returns the information with a summary of the unit's input condition	Read byte	Refer to description	Bit field	/	/	/	/	/
STATUS_TEMPER ATURE	0x7D	Returns the information with a summary of the unit's temperature condition	Read byte	Refer to description	Bit field	/	/	/	/	/
STATUS_CML	0x7E	Returns the information with a summary of the unit's communication condition	Read byte	Refer to description	Bit field	/	/	/	/	/
READ_VIN	0x88	Returns the input voltage of the module	Read word	Standard and refer to Power Management Bus data format	Linear	/	/	/	-3	/
READ_VOUT	0x8B	Returns the output voltage of the module	Read word	Standard and refer to Power Management Bus data format	Vout Linear	/	/	/	-10	/
READ_IOUT	0x8C	Returns the output current of the module	Read word	Standard and refer to Power Management Bus data format	Linear	/	/	/	0	/
READ_TEMPERAT URE_1	0x8D	Returns the temperature of the module	Read word	Standard and refer to Power Management Bus data format	Linear	/	/	/	0	/
READ_DUTY_CYC LE	0x94	Returns the duty cycle of PWM	Read word	Standard and refer to Power Management Bus data format	Linear	/	/	/	0	/
READ_DUTY_CYC LE	0x94	Returns the duty cycle of PWM	Read word	Standard and refer to Power Management Bus data format	Linear	/	/	/	0	/
READ_FREQUEN CY	0x95	Returns the frequency of PWM	Read word	Standard and refer to Power Management Bus data format	Linear	/	/	/	0	/
Power Management Bus_REVISION	0x98	Returns the revision of Power Management Bus	Read byte	Refer to description	Bit field	0x33	/	/	/	Power Management Bus V1.3
MFR_C1_C2_CON FIG	0x6C	Configure C2 pin function	R/W byte	Refer to description	Bit field	0x00	/	/	/	Default C2 function: PGOOD



MFR_C2_CONFIG	0x6D	Configure C2 pin logic	R/W byte	Refer to description	Bit field	0x00	/	/	/	Default Secondary on/off function: Secondary on/off signal ignored and Negative logic enabled
MFR_PGOOD_POLARITY	0x6E	Configure power good logic	R/W byte	Refer to description	Bit field	0x00	/	/	/	Negative PGOOD logic

OPERATION				
Bit number	Purpose	Bit value	Meaning	Default settings
7	Turn the module on/off	1	on	1
		0	off	
6	Not supported	/	/	0
5:4	Control the source of the output voltage command	00	VOUT_COMMAND	00
		01	VOUT_MARGIN_LOW	
		10	VOUT_MARGIN_HIGH	
		11	Not supported	
3:0	Reserved or Not supported	/	/	0000

ON_OFF_CONFIG				
Bit number	Purpose	Bit value	Meaning	Default settings
7:5	Reserved	/	/	000
4	Module powers up regardless of the state of the CONTROL pin and OPERATION command or not	0	Not supported	1
		1	Wait CONTROL and OPERATION	
3	Module powers up regardless of the state of the OPERATION command or not	0	Not supported	1
		1	Wait OPERATION command	
2	Module powers up regardless of the state of the CONTROL pin or not (Not supported)	0	Not supported	0
		1	Wait CONTROL pin	
1:0	Not supported	/	/	00

VOUT_OV_FAULT_RESPONSE				
Bit number	Purpose	Bit value	Meaning	Default settings
7:6	Response when fault happens	00	Not supported	10
		01	Not supported	
		10	The module shuts down and response according to the retry setting in bits[5:3]	
		11	Not supported	
5:3	Retry setting	000	Module does not attempt to restart until a RESET signal or OPERATION command or Bias power is removed	111
		001-110	Not supported	
		111	Attempts to restart continuously until it is commanded off	
2:0	Delay time	XXX	Not supported	000



Asia-Pacific  
+86 755 298 85888

Europe, Middle East  
+353 61 225 977

North America  
+1 408 785 5200

IOUT_OC_FAULT_RESPONSE				
Bit number	Purpose	Bit value	Meaning	Default settings
7:6	Response when fault happens	00	Not supported	11
		01	Not supported	
		10	Not supported	
		11	The module shuts down and response according to the retry setting in bits[5:3]	
5:3	Retry setting	000	Module does not attempt to restart until a RESET signal or OPERATION command or Bias power is removed	111
		001-110	Not supported	
		111	Attempts to restart continuously until it is commanded off	
2:0	Delay time	XXX	Not supported	000

OT_FAULT_RESPONSE				
Bit number	Purpose	Bit value	Meaning	Default settings
7:6	Response when fault happens	00	Not supported	10
		01	Not supported	
		10	The module shuts down and response according to the retry setting in bits[5:3]	
		11	Not supported	
5:3	Retry setting	000	Module does not attempt to restart until a RESET signal or OPERATION command or Bias power is removed	111
		001-110	Not supported	
		111	Attempts to restart continuously until it is commanded off	
2:0	Delay time	XXX	Not supported	000

STATUS_WORD				
Low byte				
Bit number	Purpose	Bit value	Meaning	Default settings
7	Busy	1	A fault was declared because the device was busy and unable to respond	0
		0	Not occurred	
6	Off	1	This bit is asserted if the unit is not providing power to the output, regardless of the reason, including simply not being enabled	0
		0	Not occurred	
5	VOUT_OV_FAULT	1	An output overvoltage fault has occurred	0
		0	Not occurred	
4	IOUT_OC_FAULT	1	An output overcurrent fault has occurred	0
		0	Not occurred	
3	VIN_UV_FAULT	1	An input undervoltage fault has occurred	0
		0	Not occurred	
2	TEMPERATURE	1	A temperature fault or warning has occurred	0
		0	Not occurred	
1	CML	1	A communications, memory or logic fault has occurred	0
		0	Not occurred	
0	NONE_OF_THE_ABOVE	1	A fault or warning not listed in bits [7:1] of this byte has occurred	0
		0	Not occurred	
High byte				
Bit number	Purpose	Bit value	Meaning	Default settings
7	VOUT	1	An output voltage fault or warning has occurred	0
		0	Not occurred	
6	IOUT/POUT	1	An output current or output power fault or warning has occurred	0
		0	Not occurred	
5	INPUT	1	An output overvoltage fault has occurred	0
		0	Not occurred	
4	Not supported	/	/	/
3	Not supported	/	/	/
2	Not supported	/	/	/
1	Not supported	/	/	/
0	UNKNOWN	1	A fault type not given in bits [15:1] of the STATUS_WORD has been detected	0
		0	Not occurred	

STATUS_VOUT				
Bit number	Purpose	Bit value	Meaning	Default settings
7	VOUT_OV_FAULT	1	Occurred	0
		0	Not occurred	
6	VOUT_OV_WARNING	1	Occurred	0
		0	Not occurred	
5	VOUT_UV_WARNING	1	Occurred	0
		0	Not occurred	
4	VOUT_UV_FAULT	1	Occurred	0
		0	Not occurred	
3:0	Not supported	/	/	/

STATUS_IOUT				
Bit number	Purpose	Bit value	Meaning	Default settings
7	IOUT_OC_FAULT	1	Occurred	0
		0	Not occurred	
6	Not supported	/	/	/
5	IOUT_OC_WARNING	1	Occurred	0
		0	Not occurred	
4:0	Not supported	/	/	/

STATUS_INPUT				
Bit number	Purpose	Bit value	Meaning	Default settings
7	VIN_OV_FAULT	1	Occurred	0
		0	Not occurred	
6	VIN_OV_WARNING	1	Occurred	0
		0	Not occurred	
5	VIN_UV_WARNING	1	Occurred	0
		0	Not occurred	
4	VIN_UV_FAULT	1	Occurred	0
		0	Not occurred	
3:0	Not supported	/	/	/

STATUS_TEMPERATURE				
Bit number	Purpose	Bit value	Meaning	Default settings
7	OT_FAULT	1	Occurred	0
		0	Not occurred	
6	OT_WARNING	1	Occurred	0
		0	Not occurred	
5:0	Reserved or Not supported	/	/	/

STATUS_CML				
Bit number	Purpose	Bit value	Meaning	Default settings
7	Invalid or unsupported command received	1	Occurred	0
		0	Not occurred	
6	Invalid or unsupported data received	1	Occurred	0
		0	Not occurred	
5:0	Reserved or Not supported	/	/	/

MFR_C1_C2_CONFIG				
Bit number	Purpose	Bit value	Meaning	Default settings
7:4	Reserved	/	/	/
3:0	Pin configuration	0000	C2 pin: POWER_GOOD	0000
		0010	C2 pin: ON/OFF (Secondary)	

MFR_C2_CONFIG				
Bit number	Purpose	Bit value	Meaning	Default settings
7:2	Reserved	/	/	/
1	ON/OFF Configuration	1	And- Primary and secondary side on/off	0
		0	C2 pin signal is ignored	
0	Secondary Side ON/OFF logic	1	Positive Logic (High level enable: input > 2.64V)	0
		0	Negative Logic (Low level enable: input < 0.66V)	

MFR_PGOOG_POLARITY				
Bit number	Purpose	Bit value	Meaning	Default settings
7:1	Reserved	/	/	/
0	Power Good Logic	1	Positive PGOOD logic	0
		0	Negative PGOOD logic	

Power Management Bus_REVISION				
Bit number	Purpose	Bit value	Meaning	Default settings
7:4	Indicate the revision of Power Management Bus specification Part I to which the device is compliant	0b0000	1.0	1.3
		0b0001	1.1	
		0b0010	1.2	
		0b0011	1.3	
3:0	Indicate the revision of Power Management Bus specification Part II to which the device is compliant	0b0000	1.0	1.3
		0b0001	1.1	
		0b0010	1.2	
		0b0011	1.3	



Asia-Pacific  
+86 755 298 85888

Europe, Middle East  
+353 61 225 977

North America  
+1 408 785 5200

**18. MECHANICAL DIMENSIONS**

**OUTLINE**

**0RCP-D4T120/0RCP-D4T12L**

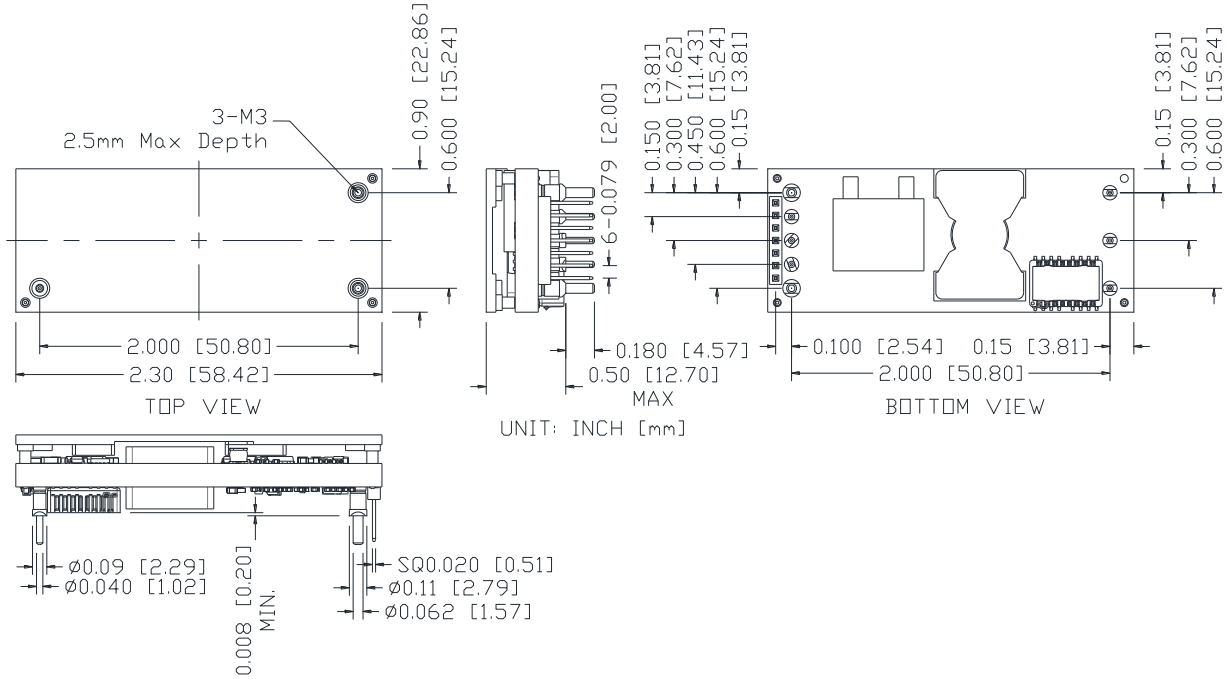

Figure 34. 0RCP-D4T120/0RCP-D4T12L outline

**Note:** This module is recommended and compatible with Pb-Free Wave Soldering and must be soldered using a peak solder temperature of no more than 260 °C for less than 5 seconds.

All Pins: Material - Copper Alloy;  
Finish - Tin plated.

Undimensioned components are shown for visual reference only.

All dimensions in inches; Tolerances: x.xx +/-0.02 in [0.5 mm]. x.xxx +/-0.010 in [0.25 mm]. Unless otherwise stated.

In pin definition, "NA" means no pin is assembled, the corresponding function is not available.



## MECHANICAL DIMENSIONS(CONTINUED)

### PIN DEFINITIONS

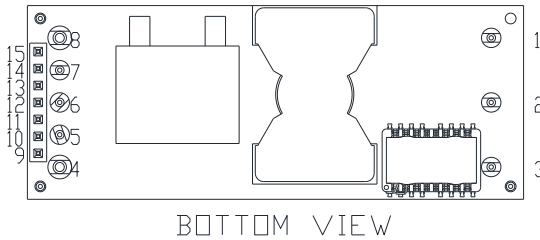

Figure 35. 0RCP-D4T120/0RCP-D4T12L pin

PIN	FUNCTION	PIN SIZE	PIN	FUNCTION	PIN SIZE
1	Vin+	0.040"	9	C2	SQ0.02"
2	Enable	0.040"	10	SIG_GND	SQ0.02"
3	Vin -	0.040"	11	DATA	SQ0.02"
4	Vout -	0.060"	12	SMBALER	SQ0.02"
5	Sense (-)	0.040"	13	CLK	SQ0.02"
6	Trim/C1	0.040"	14	ADDR1	SQ0.02"
7	Sense (+)	0.040"	15	ADDR0	SQ0.02"
8	Vout (+)	0.060"			

### RECOMMENDED PAD LAYOUT

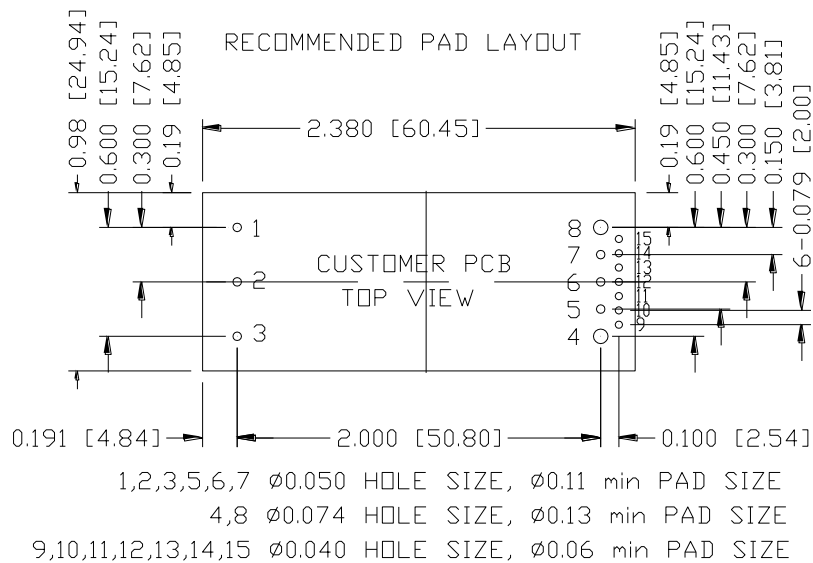

Figure 36. 0RCP-D4T120/0RCP-D4T12L recommended pad layout

**MECHANICAL DIMENSIONS(CONTINUED)**

**OUTLINE**

**0RCP-D4T12A/0RCP-D4T12B**

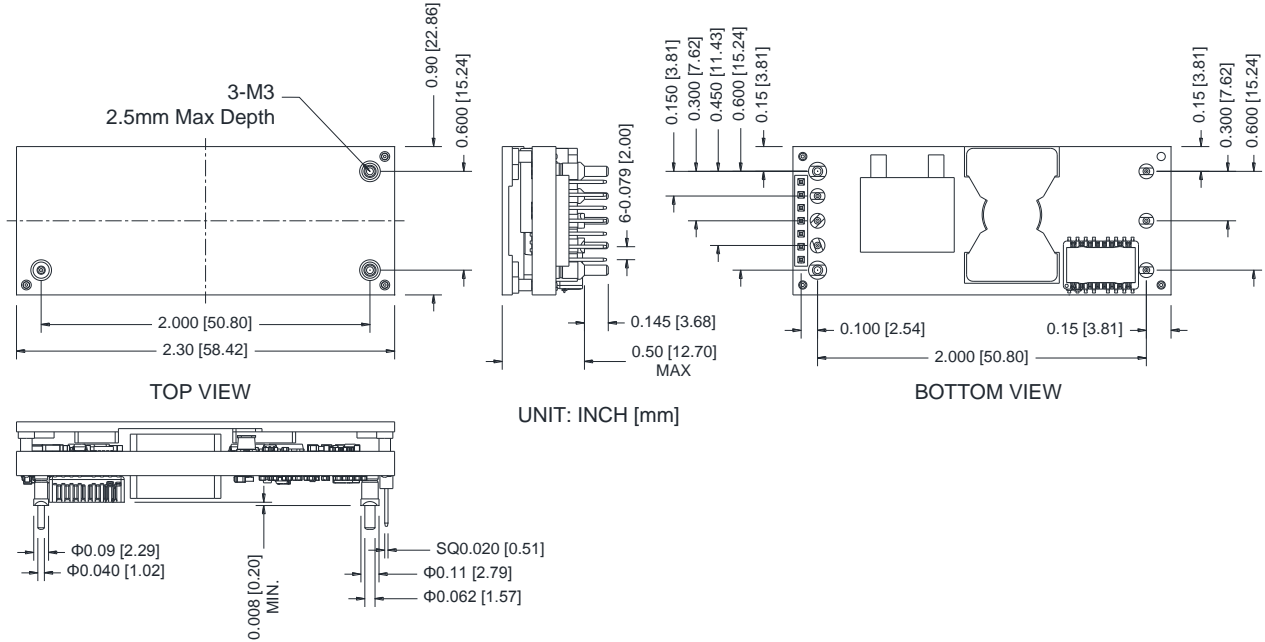

Figure 37. 0RCP-D4T12A/0RCP-D4T12B outline

**Note:** This module is recommended and compatible with Pb-Free Wave Soldering and must be soldered using a peak solder temperature of no more than 260 °C for less than 5 seconds.

All Pins: Material - Copper Alloy;  
Finish - Tin plated.

Undimensioned components are shown for visual reference only.

All dimensions in inches; Tolerances: x.xx +/-0.02 in [0.5 mm]. x.xxx +/-0.010 in [0.25 mm]. Unless otherwise stated.

In pin definition, "NA" means no pin is assembled, the corresponding function is not available.

## MECHANICAL DIMENSIONS(CONTINUED)

### PIN DEFINITIONS

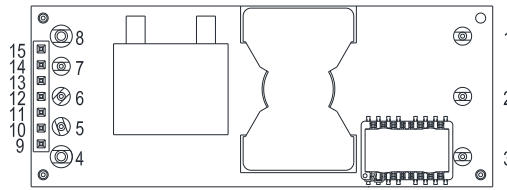

BOTTOM VIEW

Figure 38. 0RCP-D4T12A/0RCP-D4T12B pin

PIN	FUNCTION	PIN SIZE	PIN	FUNCTION	PIN SIZE
1	Vin+	F0.04"	9	C2	SQ0.02"
2	ON/OFF	F0.04"	10	SIG GND	SQ0.02"
3	Vin (-)	F0.04"	11	DATA	SQ0.02"
4	Vout (-)	F0.06"	12	SMBALERT	SQ0.02"
5	SENSE (-)	F0.04"	13	CLK	SQ0.02"
6	TRIM/C1	F0.04"	14	ADDR1	SQ0.02"
7	SENSE (+)	F0.04"	15	ADDR0	SQ0.02"
8	Vout (+)	F0.06"			

### RECOMMENDED PAD LAYOUT

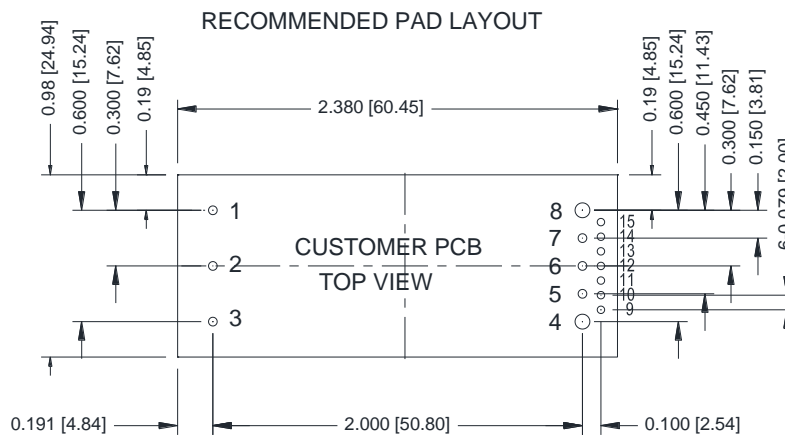

1,2,3,5,6,7  $\Phi$ 0.050 HOLE SIZE,  $\Phi$ 0.11 min PAD SIZE

4,8  $\Phi$ 0.074 HOLE SIZE,  $\Phi$ 0.13 min PAD SIZE

9,10,11,12,13,14,15  $\Phi$ 0.040 HOLE SIZE,  $\Phi$ 0.06 min PAD SIZE

Figure 39. 0RCP-D4T12A/0RCP-D4T12B recommended pad layout

## 19. REVISION HISTORY

DATE	REVISION	CHANGES DETAIL	APPROVAL
2014-6-11	A	First release	YP.Zhou
2014-12-11	B	Update Power Management Bus and output specs; Add actual waveforms and efficiency data	J.Deng
2016-12-15	AC	Update cover, input specs, output specs, general, MDB, UVLO, add wave of NR, TR, startup & shutdown.	XF.Jiang
2017-01-23	AD	Update input specs, output specs, efficiency data, trim, startup & shutdown, remote onoff, ocp, UVLO, other.	XF.Jiang
2017-12-14	AE	Update cover, output specs, General, TD, Trim, MDB, Remote on/off, Safety&EMC	J.Yao
2018-03-01	AF	Update TD.	J.Yao
2018-04-10	AG	Add ORCP-D4T12A and ORCP-D4T12B.	J.Yao
2018-09-29	AH	Update the form, MTBF, weight.Add thermal considerations and thermal test setup.	J.Yao
2019-01-15	AI	Update Power Management Bus	YL.Zheng
2019-07-08	AJ	Update Power Management Bus	YP.Zhou

For more information on these products consult: [tech.support@psbel.com](mailto:tech.support@psbel.com)

**NUCLEAR AND MEDICAL APPLICATIONS** - Products are not designed or intended for use as critical components in life support systems, equipment used in hazardous environments, or nuclear control systems.

**TECHNICAL REVISIONS** - The appearance of products, including safety agency certifications pictured on labels, may change depending on the date manufactured. Specifications are subject to change without notice.



[tech.support@psbel.com](mailto:tech.support@psbel.com)  
[belfuse.com/power-solutions](http://belfuse.com/power-solutions)