

- * High Reliability by S.M.T. & TQC.
- * With Cold Junction Compensation, Suited to Operated at -20 C ~ +60 C
- * All type with Sensor Break Alarm LED.
- * With P+D Control to Control Temperature Easily.
- * High Accuracy of Displaying & Setting Less than 0.5% of F.S.
- * With Stand-by/Over-heat Alarm.(Optioned).
- * With Heater Break Alarm.(Optioned).
- * 表面貼焊技術及全面品管，提供最可靠性產品
- * 具冷接點補償，適用於周圍溫度 -20 C ~ +60 C
- * 全機種具有測溫體斷線警報
- * P+D 控制易於控溫
- * 高精度的顯示及設定精度，低於全刻度 0.5%
- * 具有待機／過熱警報功能（選擇機種）
- * 具有加熱器斷線警報功能（選擇機種）

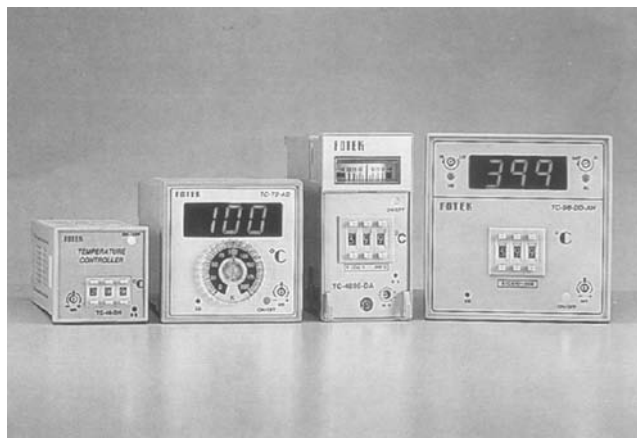

■ Guiding of Model

Ex. TC - 4896 DA - PT - R 3 - F - S - A

① ② ③④ ⑤ ⑥⑦ ⑧ ⑨ ⑩

① Product 產品代號

TC = Temperature Controller

② Outline 外型

48 = 48(W) X 48(H) mm X mm
 4896 = 48(W) X 96(H) mm X mm
 72 = 72(W) X 72(H) mm X mm
 96 = 96(W) X 96(H) mm X mm

③ Method of Setting 設定方式

D = Digital Swith
 A = Trimmer

④ Method of Display 顯示方式

A = Analog Deviation Meter
 D = Digital LED Display
 N = Without Display

⑤ Type of Sensor 感溫線種類

PT = RTD PT-100 Ω
 J = J Type Thermocouple
 Non = K Type Thermocouple

⑥ Method of Output 輸出方式

R = Relay (5A/250VAC)
 V = Voltage (20mA/12V)
 L = Linear (4~20mA)

⑦ Range of Setting 設定範圍

Digital Switch

0 = -99 ~ + 99
 1 = 0 ~ +199
 3 = 0 ~ +399
 5 = 0 ~ +599
 9 = 0 ~ +999
 11 = 0 ~ +1199

Trimmer

05 = -50 ~ +50
 1 = 0 ~ +100
 2 = 0 ~ +200
 4 = 0 ~ +400
 6 = 0 ~ +600
 12 = 0 ~ +1200

⑧ Unit of Degree 刻度單位

F = F
 non = C

⑨ Method of Control 控制方式

S = ON/OFF
 non = P+D ON/OFF

⑩ Alarm 警報

A = With Stand-by / Over Heat Alarm
 AH = With Stand-by / Over Heat Alarm
 & Heater Break Alarm
 Non = Without Alarm

General Data 共同規格	Sensor Type 感溫線	K < CA > , J < IC > or PT-100 Ω
	Output Method 輸出方式	Relay < 5A / 250VAC > , Voltage < 20mA / 12V > , Linear < 4~20mA >
	Control Method 控制方式	P+D ON/OFF , ON/OFF or Proportion
	Proportion Band 比例帶	Appro 2.5% of F.S.
	Cycle Time 動作週期	2 Sec or 20 Sec < ON+OFF >
	Manual Reset 偏移修正	Trimmer, Range ± 10°
	Unit of Degree 單位	°C or °F
AL Alarm AI警報	Setting Method 設定方式	Trimmer (AL)
	Setting Range 設定範圍	0 ~ +50° , 0 ~ -50° or -50° ~ +50° of Setting Value
	Output Method 輸出方式	Relay , 0.5A/250VAC
HB Alarm Hb警報	Setting Method 設定方式	Trimmer (HB)
	Setting Range 設定範圍	0.5A~25A ; 1.0A~50A
	Output Method 輸出方式	Relay , 0.5A/250VAC
Electrical Data 電氣規格	Power Supply 工作電壓	110 / 220 VAC ± 20% 50 / 60Hz
	Current Consumption 耗電流	2.5VA max.
	Insulation Resistance 絕緣阻抗	Over 50M Ω / 500 VDC Between Power And Another Terminal
	Dielectrical Strength 耐壓強度	Over 2.5KV / 1min Between Power And Another Terminal
Mechanical Data 機械規格	Operating Temp./Hum 工作環境	-20°C ~ +60°C ; 35%~85% RH
	Vibration Resistance 耐振動	10~55Hz / 1.5mm , 2Hrs in X.Y.Z Direction
	Panel Thickness 面板厚度	1.0~8.0mm

■ Attachment/附件

CT provided with Heater Break Alarm type only.
只有加熱器斷線警報功能機種附 CT

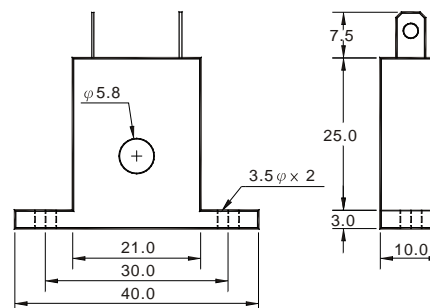

TC-4896 Series

DIN 48X96 Temperature Controller

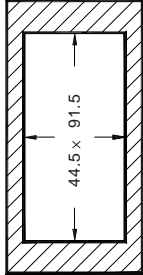
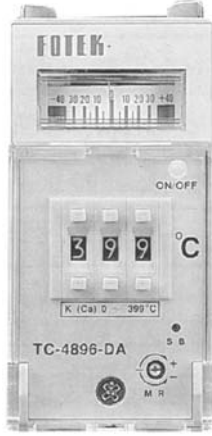
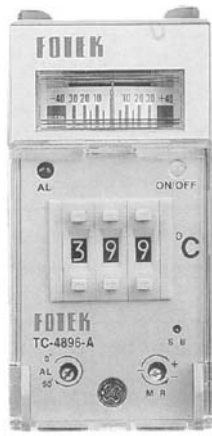
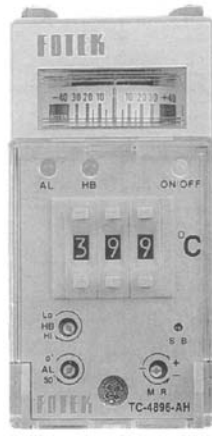
Model	TC-4896-DA-□-□	TC-4896-DA-□-□-A	TC-4896-DA-□-□-AH
DIN48 X 96 			
Alarm 警報	Non	AL Alarm	AL+HB
Display 顯示方式	Method 方式	Analog Deviation Meter	
	Tolerance 誤差	1.0% of F.S.	
	Range 範圍	±40°	
Setting 設定方式	Method 方式	Digital Switch < 3 Digits >	
	Tolerance 誤差	0.5% of Setting Range	
	Range 範圍	-99~+99 , 0~199 , 0~399 , 0~599 , 0~999	

Dimension & Fixed Hole / 外型及固定孔尺寸

Outline

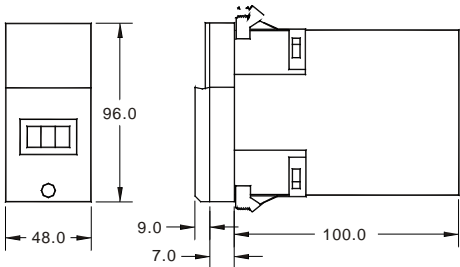

Fixed Hole (Thickness 1~8mm)

Single Cutout Multi Juxtaposed Cutout
 單個開孔 多個並排開孔

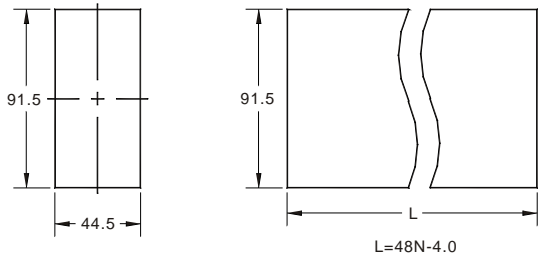





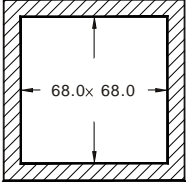

L=48N-4.0

N	2	3	4	5	6
L	92.0	140.0	188.0	236.0	284.0

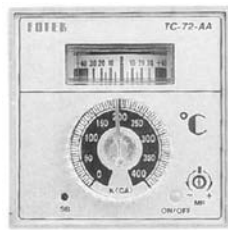
DIN 72X72 Temperature Controller

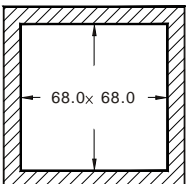
TC-72 Series

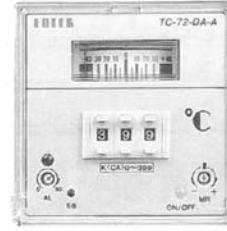

	Model	TC-72-AN-□-□	TC-72-AA-□-□	TC-72-AA-□-□- A
Outline 外型	DIN72 X 72 			
	Alarm 警報	Non	Non	AL Alarm
Display 顯示方式	Method 方式	Non	Analog Deviation Meter	
	Tolerance 誤差	Non	1.0% of F.S.	
	Range 範圍	Non	± 40°	
Setting 設定方式	Method 方式	Trimmer < Variable Resister >		
	Tolerance 誤差	1.0% of Setting Range		
	Range 範圍	0~100 , 0~200 , 0~400 , 0~600 , 0~1200		
	Model	TC-72-DN-□-□	TC-72-DA-□-□	TC-72-DA-□-□- A
Outline 外型	DIN72 X 72 			
	Alarm 警報	Non	Non	AL Alarm
Display 顯示方式	Method 方式	Non	Analog Deviation Meter	
	Tolerance 誤差	Non	1.0% of F.S.	
	Range 範圍	Non	± 40°	
Setting 設定方式	Method 方式	Digital Switch		
	Tolerance 誤差	0.5% of Setting Range		
	Range 範圍	-99 ~+99 , 0~199 , 0~399 , 0~599 , 0~999 , 0~1199		

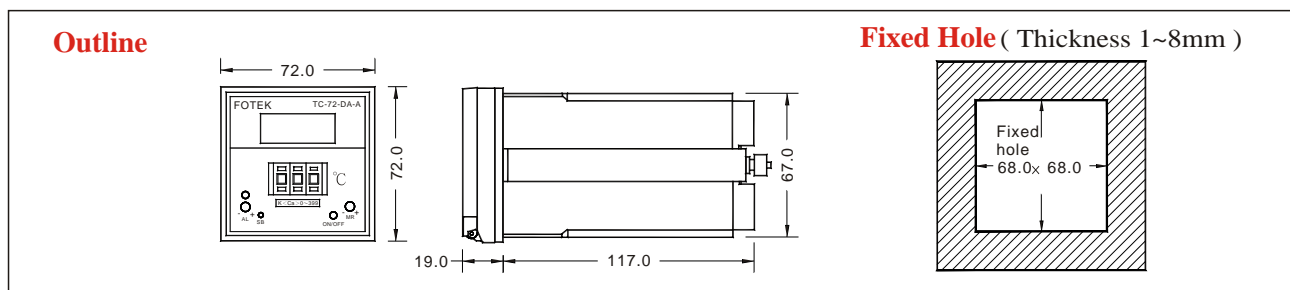
Dimension & Fixed Hole/外型及固定孔尺寸





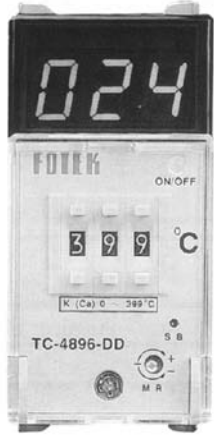

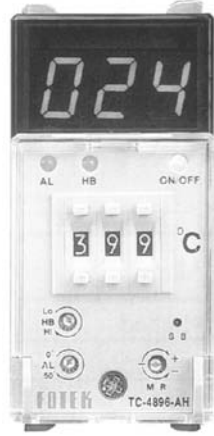
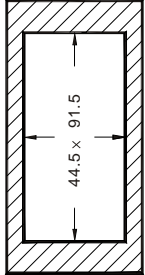

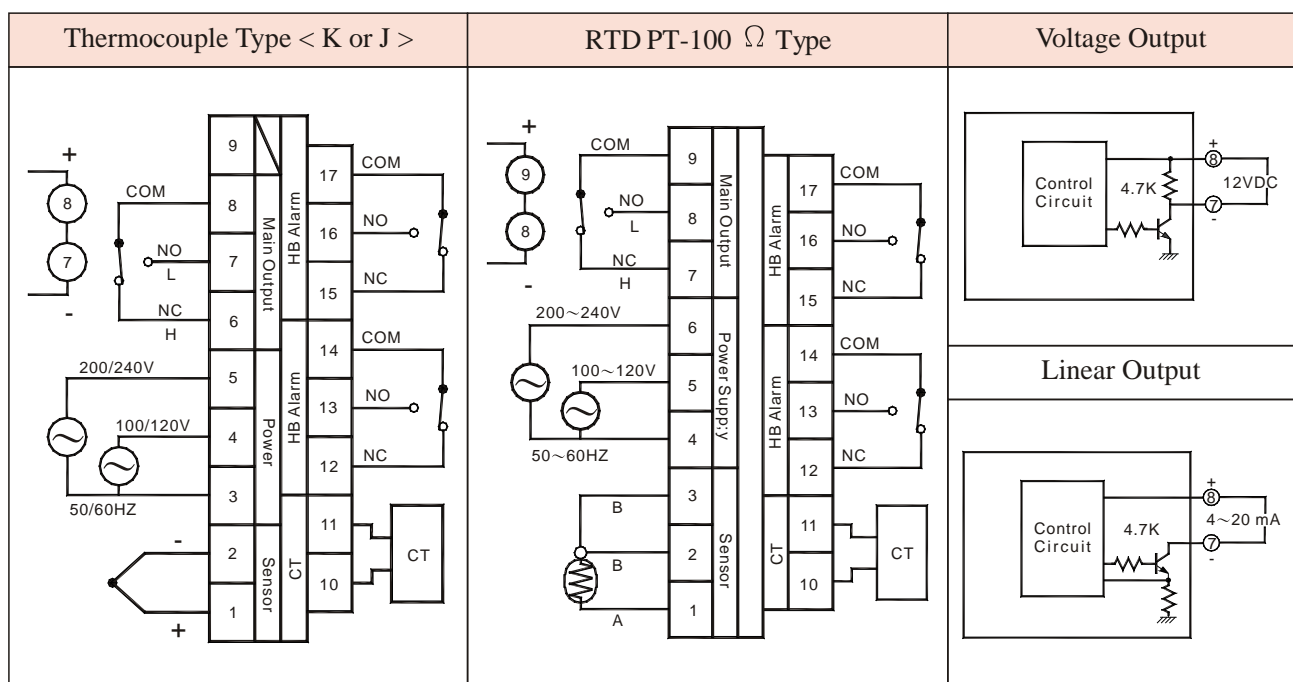

DIN 48X96 Temperature Controller

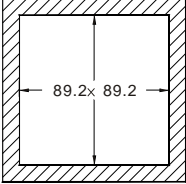
TC-4896 Series

	Model	TC-4896-DD-□-□	TC-4896-DD-□-□-A	TC-4896-DD-□-□-AH
Outline 外型	DIN48 X 96			
				
Alarm 警報		Non	AL Alarm	AL+HB
Display 顯示方式	Method 方式	14 mm 7 Segment Red LED		
	Tolerance 誤差	0.5% of F.S. + 1 Digit		
	Range 範圍	-99~+99, 0~999		
Setting 設定方式	Method 方式	Digital Switch < 3 Digits >		
	Tolerance 誤差	0.5% of Setting Range		
	Range 範圍	-99~+99, 0~199, 0~399, 0~599, 0~999		

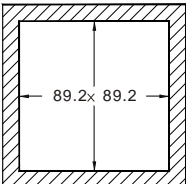
Connection Diagram & Output Circuit 接線圖及輸出回路





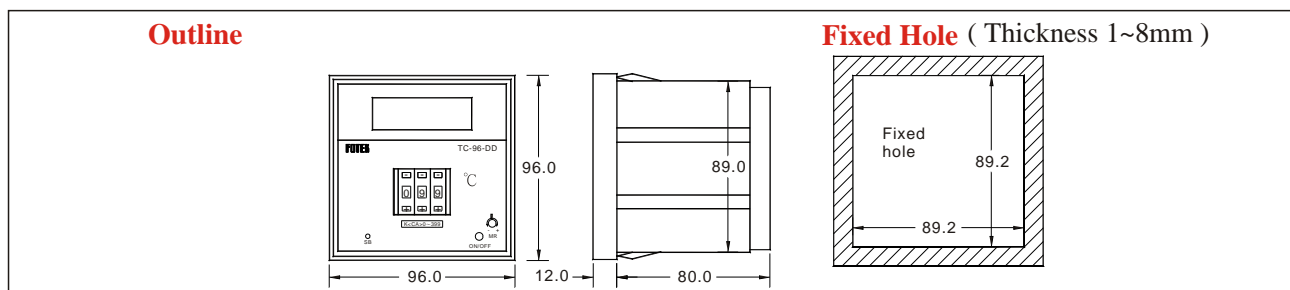

	Model	TC-96-AD-□-□	TC-96-AD-□-□-A	TC-96-AD-□-□-AH
Outline 外型	DIN96 X 96 			
	Alarm 警報	Non	AL Alarm	AL+HB Alarm
Display 顯示方式	Method 方式	14mm 7 Segment Red LED		
	Tolerance 誤差	0.5% of F.S.		
	Range 範圍	-99 ~+99 , 0~999 , 0~1200		
Setting 設定方式	Method 方式	Trimmer < Variable Resister >		
	Tolerance 誤差	1.0% of F.S.		
	Range 範圍	-50 ~+50 , 0~100 , 0~200 , 0~400 , 0~600 or 0~1200		
	Model	TC-96-DD-□-□	TC-96-DD-□-□-A	TC-96-DD-□-□-AH
Outline 外型	DIN96 X 96 			
	Alarm 警報	Non	AL Alarm	AL+HB Alarm
Display 顯示方式	Method 方式	14mm 7 Segment Red LED		
	Tolerance 誤差	0.5% of F.S.		
	Range 範圍	-99 ~+99 , 0~999 , 0~1200		
Setting 設定方式	Method 方式	Digital Switch		
	Tolerance 誤差	0.5% of F.S.		
	Range 範圍	-99 ~+99 , 0~199 , 0~399 , 0~599 , 0~999 , 0~1199		

Dimension & Fixed Hole/外型及固定孔尺寸



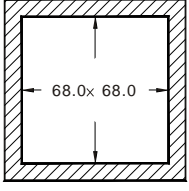

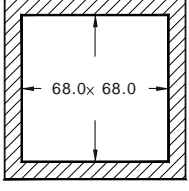

TC-72 Series

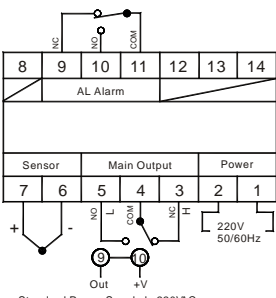
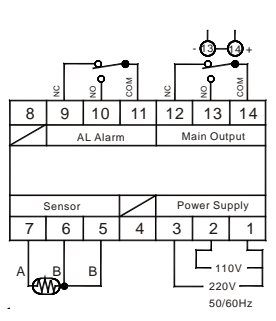
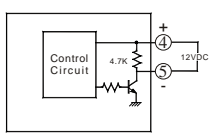
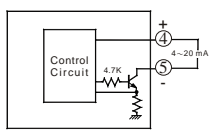

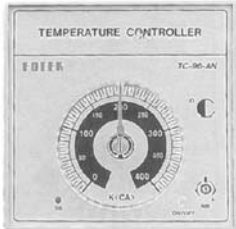

	Model	TC-72-AD-□-□	TC-72-AD-□-□-A
Outline 外型	DIN72 X 72		
			
	Alarm 警報	Non	AL Alarm
Display 顯示方式	Method 方式	14mm 7 Segment Red LED	
	Tolerance 誤差	0.5% of F.S.	
	Range 範圍	0~999 or 0~1999	
Setting 設定方式	Method 方式	Trimmer < Variable Resister >	
	Tolerance 誤差	1.0% of F.S.	
	Range 範圍	0~100 , 0~200 , 0~400 , 0~600 , 0~1200	

	Model	TC-72-DD-□-□	TC-72-DD-□-□-A
Outline 外型	DIN72 X 72		
			
	Alarm 警報	Non	AL Alarm
Display 顯示方式	Method 方式	14mm 7 Segment Red LED	
	Tolerance 誤差	0.5% of F.S.	
	Range 範圍	-99~99 , 0~999 or 0~1999	
Setting 設定方式	Method 方式	Digital Switch	
	Tolerance 誤差	0.5% of Setting Range	
	Range 範圍	-99 ~+99 , 0~199 , 0~399 , 0~599 , 0~999 , 0~1199	

K type	PT type	Voltage Output
 <p>Standard Power Supply Is 220VAC If Need 110VAC, Please Change It On, The Inner PC Board.</p>		
		Linear Output
		

TC-96 Series

TC-96-AN-□-□	TC-96-AA-□-□	TC-96-AA-□-□-A	TC-96-AA-□-□-AH
			
Non	Non	AL Alarm	AL+HB Alarm
Non	Analog Deviation Meter		
Non	1.0% of F.S.		
Non	$\pm 40^\circ$		
Trimmer < Variable Resister >			
1.0% of F.S.			
-50 ~+50 , 0~100 , 0~200 , 0~400 , 0~600 or 0~1200			

TC-96-DN-□-□	TC-96-DA-□-□	TC-96-DA-□-□-A	TC-96-DA-□-□-AH
			
Non	Non	AL Alarm	AL+HB Alarm
Non	Analog Deviation Meter		
Non	1.0% of F.S.		
Non	$\pm 40^\circ$		
Digital Switch			
0.5% of F.S.			
-99 ~+99 , 0~199 , 0~399 , 0~599 , 0~999 , 0~1199			

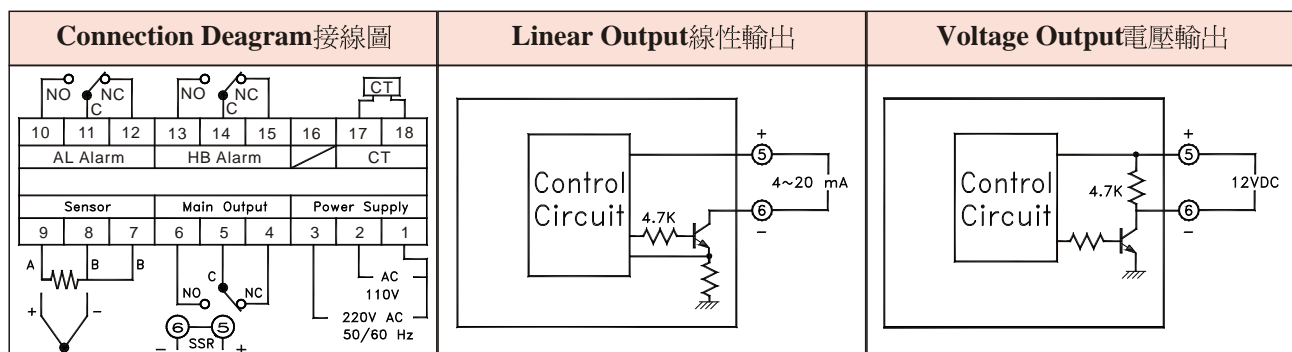

■ Control Output 控制輸出

ON/OFF LED Turn to Green Color , Control Output Turn ON. 綠色動作燈，表示控制輸出動作。
 ON/OFF LED Turn to Red Color , Control Output Turn OFF. 紅色動作燈，表示控制輸出復歸。
 but , Linear Output Type That ON/OFF LED Turn to Green Color. 但，線性輸出型，動作燈亮綠色。

■ Sensor Break Alarm (SB) 測溫體斷線指示燈

SB LED Turn ON when Sensor Break 測溫體斷線時，SB燈會亮著。

■ Stand-by/Over-heat Alarm (AL) 待機 / 過熱警報

SV = Setting Value 設定溫度值

AV1/AV2 = Stand-by/Over-heat Value 待機 / 過熱設定值

DIP Switch to Select Function

on Inner PC Board

功能選擇DIP 開關在內部機板上。

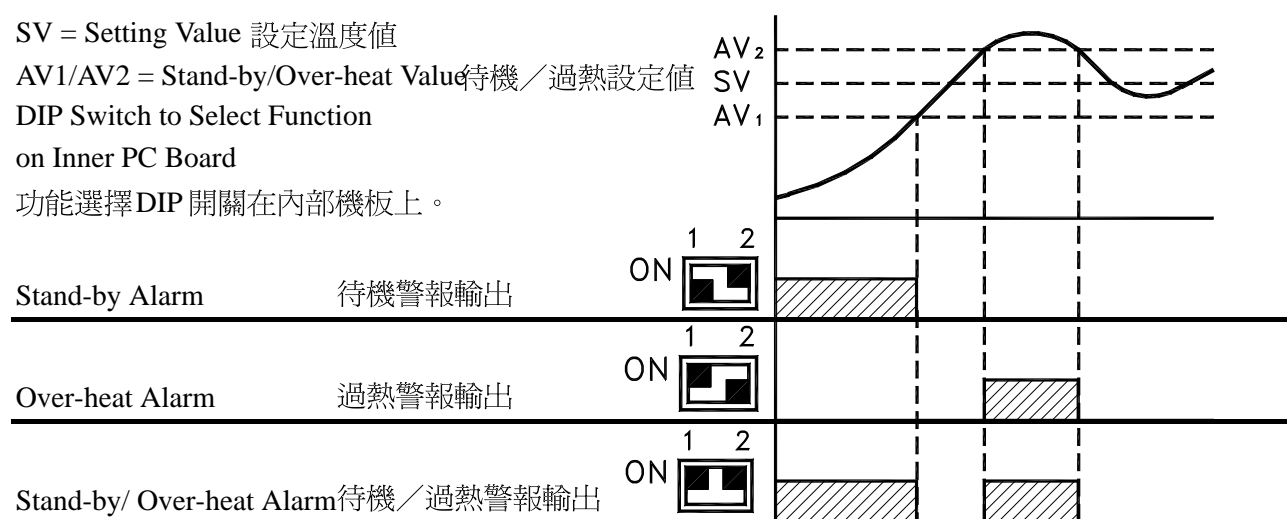

■ Heater Break Alarm (HB) 加熱器斷線警報

Heater Break Alarm Output Turns ON when the Current of Heater Lower than Setting Value that may set at Front Panel. (0.5A~25A standard/1.0A~50A Optioned)

當加熱器電流低於設定值時，加熱器斷線警報即動作，設定值可在面板設定，標準 0.5A~25A，訂做 1.0A~50A

■ Illustration/説明

P+D ON/OFF

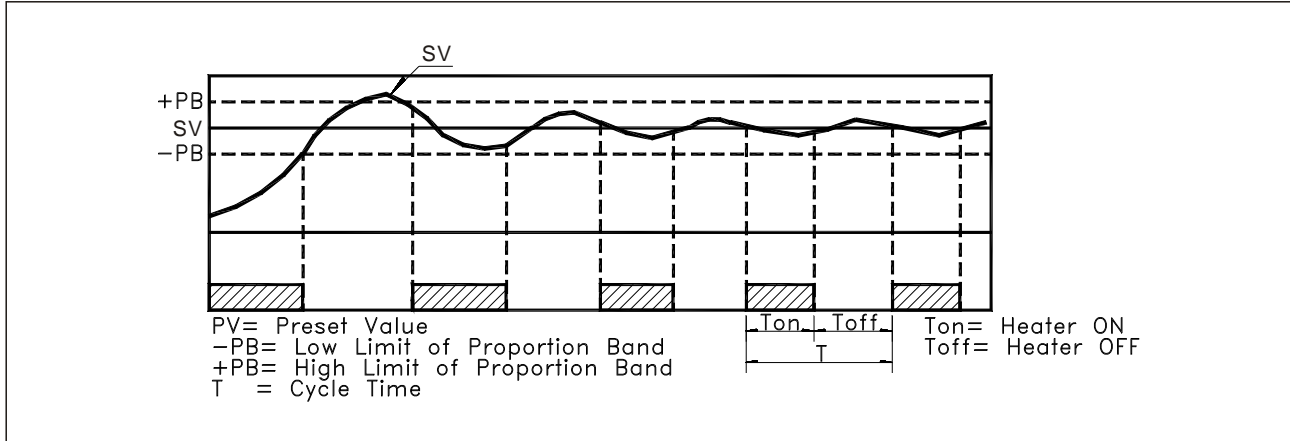

ON/OFF (S)

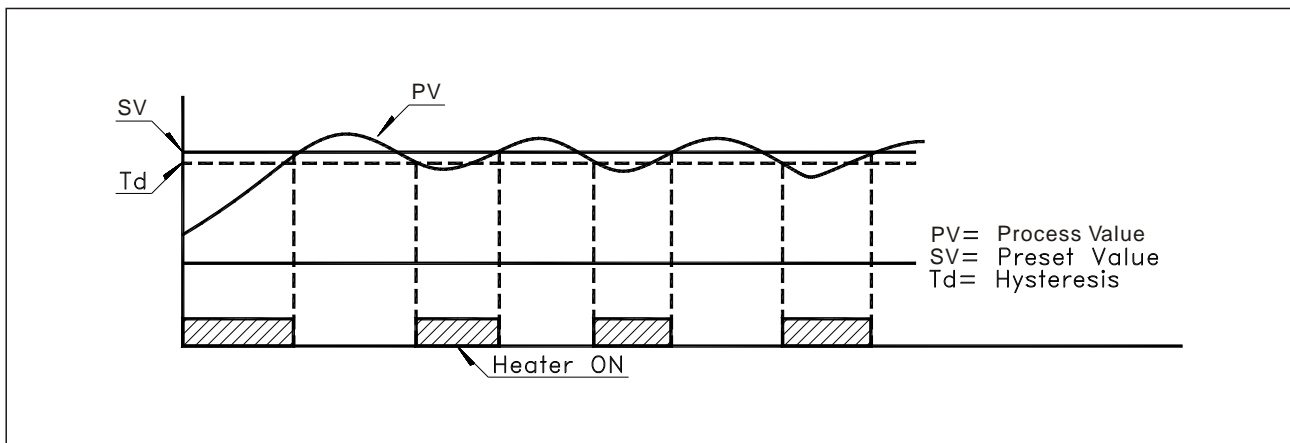

Proportion

