

## 10 A DPDT MINIATURE POWER RELAY

### FEATURES

- Dielectric strength 5000 Vrms
- Low height: 15.7 mm
- Epoxy sealed version available
- 10 Amp switching (N.O. contact only)
- AC and DC coils
- Isolation spacing greater than 10 mm
- Proof tracking index (PTI/CTI) 250
- Reinforced insulation, EN 60730-1 (VDE 0631, part 1) EN 60335-1 (VDE 0700, part 1)
- UL, CUR file E43203
- VDE certificate 40012572



### CONTACTS

<b>Arrangement</b>	DPDT (2 Form C) DPST (2 Form A)
<b>Ratings</b>	Resistive load:  Max. switched power: 2 X 240 W or 2500 VA Max. switched current: 2 X 10 A Max. switched voltage: 300 VDC* or 400 VAC  * Note: If switching voltage is greater than 30 VDC, special precautions must be taken. Please contact the factory.
<b>Rated Load UL, CUR</b>	8 A at 250 VAC resistive [1][2] 10 A at 250 VAC resistive, 30k cycles (N.O.) [1]
<b>VDE</b>	2 Form A - DC coil 8 A at 250 VAC, 100k cycles, 85°C [1] 8 A at 250 VAC, 10k cycles, 85°C [2]  2 Form A - AC coil 8 A at 250 VAC, 80k cycles, 70°C [1] 8 A at 250 VAC, 40k cycles, 70°C [2]  2 Form C - DC coil 8 A at 250 VAC, 30k cycles, 70°C [1] 8 A at 250 VAC, 20k cycles, 85°C [1] 8 A at 250 VAC, 10k cycles, 85°C [2]  2 Form C - AC coil 8 A at 250 VAC, 80k cycles, 70°C [1] 8 A at 250 VAC, 10k cycles, 70°C [2]
<b>Material</b>	Silver nickel [1], silver tin oxide [2], gold plating available
<b>Resistance</b>	< 100 milliohms initially

### NOTES

1. All values at 20°C (68°F).
2. Relay may pull in with less than "Must Operate" value.
3. Specifications subject to change without notice.

### GENERAL DATA

<b>Life Expectancy Mechanical Electrical</b>	Minimum operations 3 x 10 <sup>7</sup> 1 x 10 <sup>5</sup> at 8 A 250 VAC res.
<b>Operate Time (typical)</b>	7 ms at nominal coil voltage
<b>Release Time (typical)</b>	3 ms at nominal coil voltage (with no coil suppression)
<b>Dielectric Strength (at sea level for 1 min.)</b>	5000 Vrms coil to contact 2500 Vrms between contact sets 1000 Vrms between open contacts
<b>Insulation Resistance</b>	10 <sup>5</sup> megohms min. at 500 VDC, 20°C, 50% RH
<b>Insulation (according to DIN VDE 0110, IEC 60664-1)</b>	B250 at 2 Form C, flux proof version C250 at other relay versions Overvoltage category: III Pollution degree: 3 Nominal voltage: 250 VAC
<b>Dropout DC coils AC coils</b>	Greater than 10% of nominal coil voltage Greater than 15% of nominal coil voltage
<b>Ambient Temperature Operating</b>	At nominal coil voltage -40°C (-40°F) to 85°C (185°F) - DC coils -40°C (-40°F) to 70°C (158°F) - AC coils
<b>Vibration</b>	Break contacts: 5 g at 20...500 Hz Make contacts: 20 g at 30...500 Hz
<b>Shock</b>	20 g
<b>Enclosure</b>	P.B.T. polyester, UL-94 : V0
<b>Terminals</b>	Tinned copper alloy, P.C.
<b>Max. Solder Temp.</b>	270°C (518°F)
<b>Max. Solder Time</b>	5 seconds
<b>Max. Solvent Temp.</b>	80°C (176°F)
<b>Max. Immersion Time</b>	30 seconds
<b>Weight</b>	14 grams
<b>Packing unit in pcs</b>	20 per carton tube / 1000 per carton box

### COIL

<b>Power</b>	
<b>At Pickup Voltage (typical)</b>	200 mW (DC coil) .422 VA (AC coil)
<b>Max. Continuous Dissipation</b>	1.7 W at 20°C (68°F) ambient 1.7 VA at 20°C (68°F) ambient
<b>Temperature Rise</b>	26°C (47°F) at nominal coil voltage
<b>Max. Temperature</b>	155°C (311°F) Class F

## ZETTLER electronics GmbH

Junkersstr. 3, D-82178 Puchheim, Germany

phone: +49 89 800 97-0 office@ZETTLERelectronics.com  
fax: +49 89 800 97-200 www.ZETTLERelectronics.com

This product specification to be used only together with the application notes which can be downloaded from <http://www.ZETTLERelectronics.com/pdfs/relais/ApplicationNotes.pdf>

2012-08-23

# AZ742

## RELAY ORDERING DATA

COIL SPECIFICATIONS - DC COIL				ORDER NUMBER*	
Nominal Coil VDC	Must Operate VDC	Max. Continuous VDC	Coil Resistance Ohm $\pm 10\%$	2 Form A	2 Form C
3	2.1	7.6	22	AZ742-2A-3D	AZ742-2C-3D
5	3.5	12.7	60	AZ742-2A-5D	AZ742-2C-5D
6	4.2	15.3	90	AZ742-2A-6D	AZ742-2C-6D
9	6.3	22.9	200	AZ742-2A-9D	AZ742-2C-9D
12	8.4	30.6	360	AZ742-2A-12D	AZ742-2C-12D
18	12.6	45.9	710	AZ742-2A-18D	AZ742-2C-18D
24	16.8	61.2	1,440	AZ742-2A-24D	AZ742-2C-24D
36	25.2	92.0	3,140	AZ742-2A-36D	AZ742-2C-36D
48	33.6	122.0	5,700	AZ742-2A-48D	AZ742-2C-48D
60	42.0	153.0	7,500	AZ742-2A-60D	AZ742-2C-60D
110	77.0	280.0	25,200	AZ742-2A-110D	AZ742-2C-110D

COIL SPECIFICATIONS - AC COIL					ORDER NUMBER*	
Nominal Coil VAC	Must Operate VAC	Max. Continuous VAC	Nominal Current mA $\pm 10\%$	Coil Resistance Ohm $\pm 10\%$	2 Form A	2 Form C
12	9.0	18.0	63.0	100	AZ742-2A-12A	AZ742-2C-12A
24	18.0	36.0	31.3	400	AZ742-2A-24A	AZ742-2C-24A
48	36.0	72.0	15.6	1,550	AZ742-2A-48A	AZ742-2C-48A
60	45.0	90.0	12.5	2,600	AZ742-2A-60A	AZ742-2C-60A
110	82.5	165.0	6.8	8,900	AZ742-2A-110A	AZ742-2C-110A
115	86.3	172.5	6.5	9,600	AZ742-2A-115A	AZ742-2C-115A
120	90.0	180.0	6.3	10,200	AZ742-2A-120A	AZ742-2C-120A
220	165.0	330.0	3.4	35,500	AZ742-2A-220A	AZ742-2C-220A
230	172.5	345.0	3.3	38,500	AZ742-2A-230A	AZ742-2C-230A
240	180.0	360.0	3.1	42,500	AZ742-2A-240A	AZ742-2C-240A

\* "2A" or "2C" denote silver nickel contacts.  
 Add suffix "G" at "2A" or "2C" for gold plated silver nickel contacts.  
 Add suffix "E" at "2A" or "2C" for silver tin oxide contacts.  
 Add suffix "E" at the end of order number for sealed version.

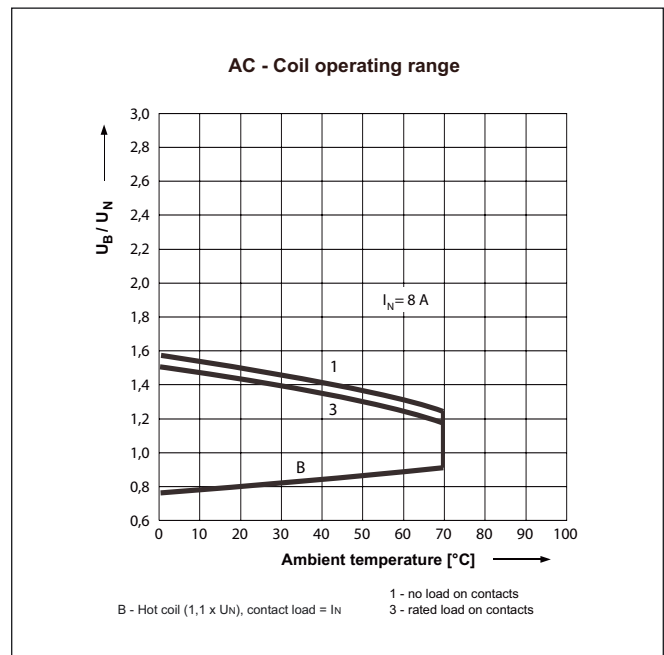
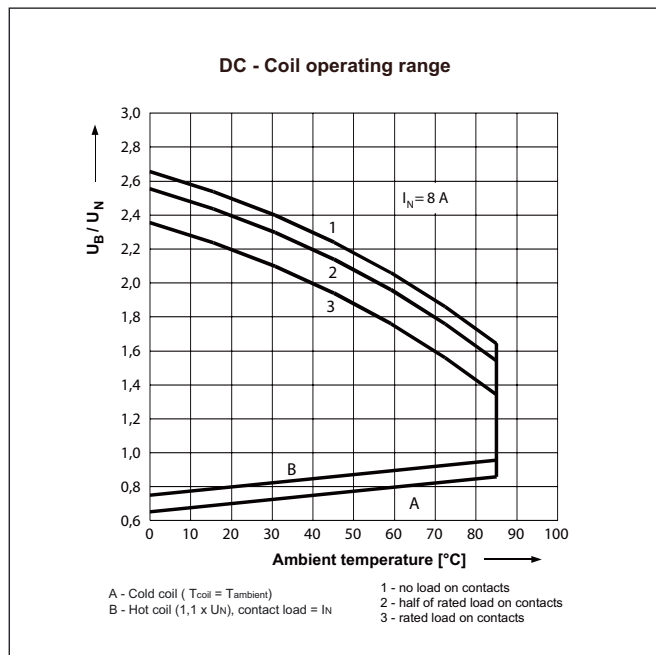

## ZETTLER electronics GmbH

Junkersstr. 3, D-82178 Puchheim, Germany

phone: +49 89 800 97-0 office@ZETTLERelectronics.com

fax: +49 89 800 97-200 www.ZETTLERelectronics.com

This product specification to be used only together with the application notes which can be downloaded from <http://www.ZETTLERelectronics.com/pdfs/relais/ApplicationNotes.pdf>

2012-08-23

# AZ742

## MECHANICAL DATA

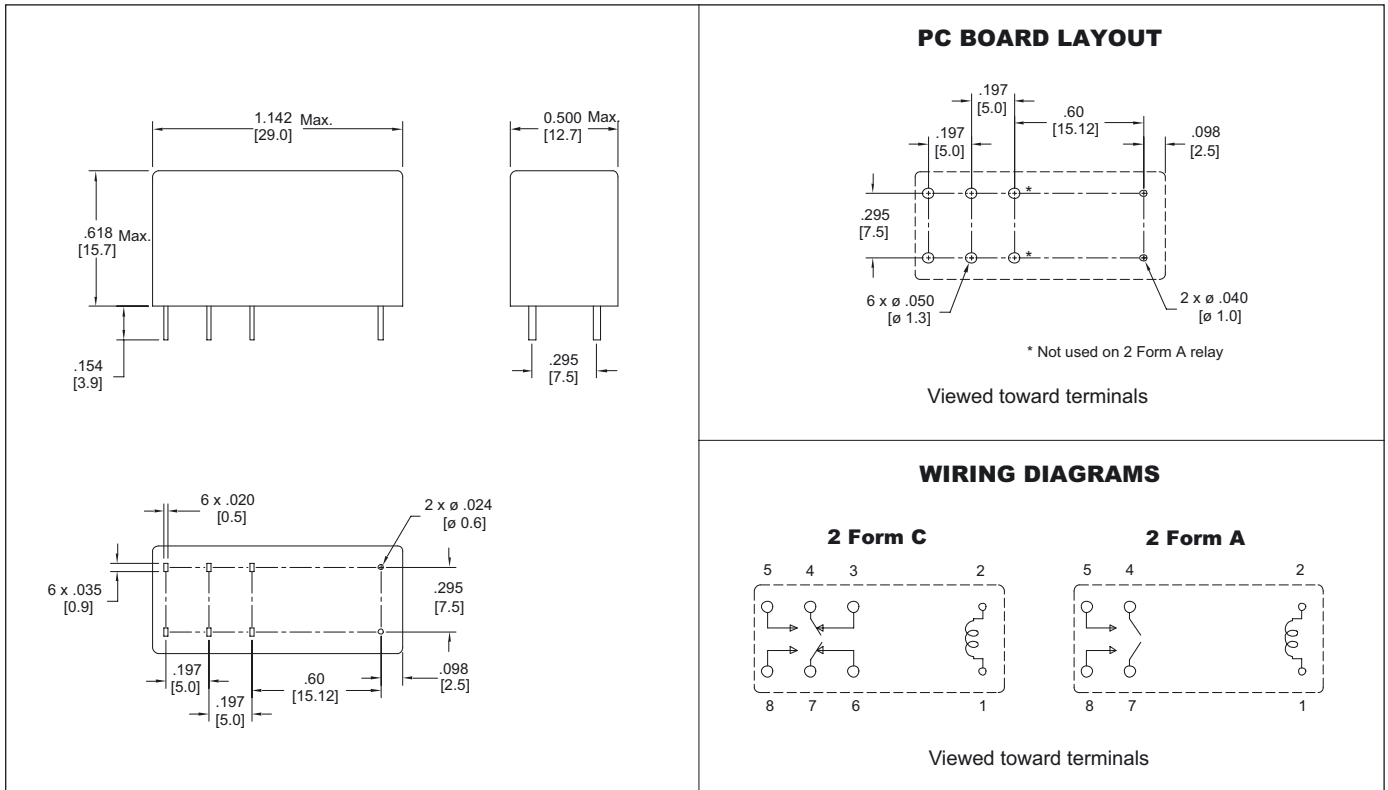

## ACCESSORIES

For P.C.B. mount: Socket EC 50  
Retaining Clip MP 16 / MH 16



For DIN rail mount: Socket ES 50  
Retaining Clip MS 16

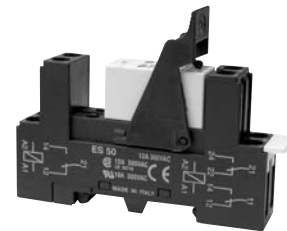

## MECHANICAL DATA

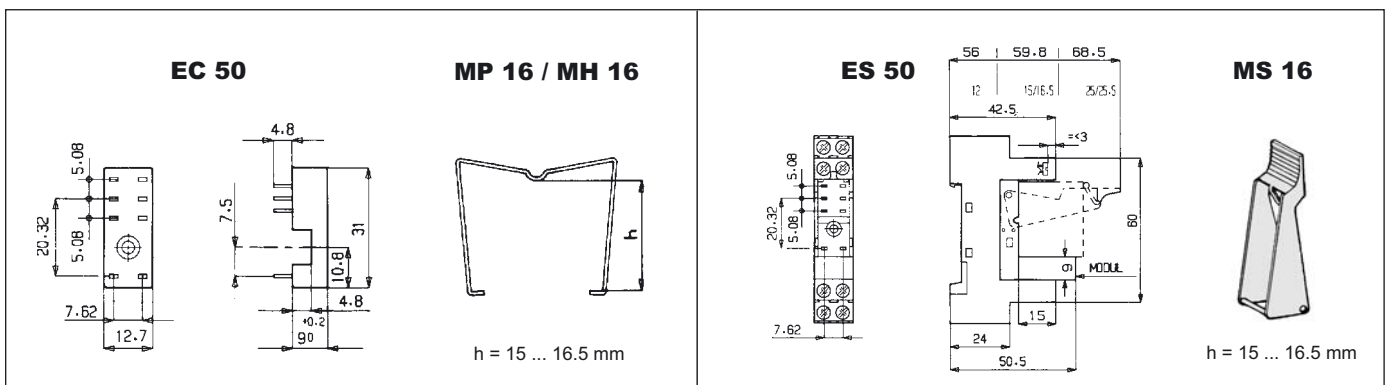

# ZETTLER electronics GmbH

Junkersstr. 3, D-82178 Puchheim, Germany

phone: +49 89 800 97-0 office@ZETTLERelectronics.com

fax: +49 89 800 97-200 www.ZETTLERelectronics.com

This product specification to be used only together with the application notes which can be downloaded from <http://www.ZETTLERelectronics.com/pdfs/relais/ApplicationNotes.pdf>

2012-08-23

Electrical life at 250 VAC, resistive load

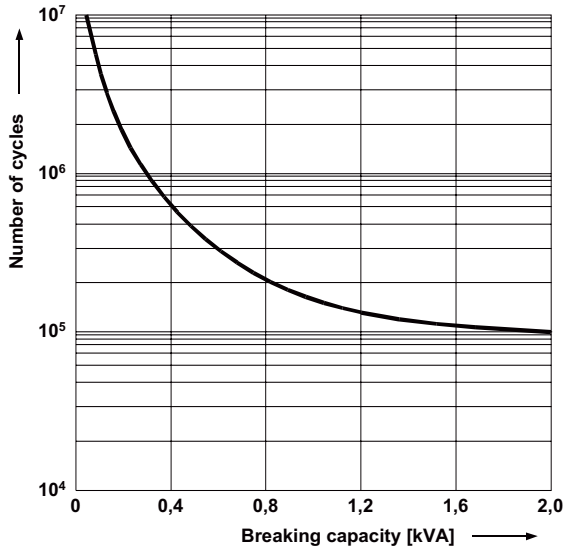

Electrical life reduction factor at inductive AC load

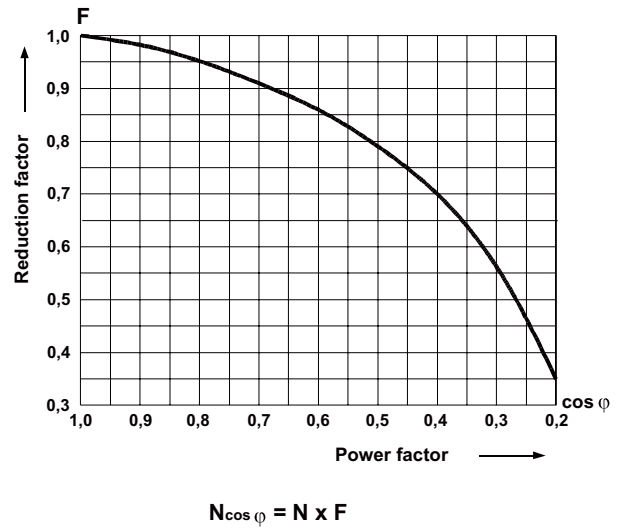

Max. DC resistive load breaking capacity

