



# MEA-5IG-MA

5G NR, Iridium and GNSS Magnetic/Adhesive Mount

Part #: 100-00206-01

## Description

The MEA-5IG-MA magnet adhesive Mount Antenna is a 3-in-1 low profile antenna solution, with a very high-performance ideal for maintaining constant network connectivity. The MEA-5IG-MA covers all 5G NR, Iridium and GPS/GLONASS/QZSS/Galileo standard frequencies. This is an ideal antenna for telematics systems, remote surveillance, asset tracking and any IOT system applications. The high performance and low profile make this antenna ideal for the most challenging installations.

This screw mount antenna is easy to install with maximum durability offering IP67 rated housing and anti-rotation mounting. The MEA-5IG-MA has a three cables with a SMA-Male standard connectors, 3m standard cable length and is fully customizable by offering additional connector types, cable lengths and cable types.



## Electrical Specification

Cable 1 - 5G NR Antenna

Parameter	Specification	
Frequency Range	617-960 MHz	1427-2690 MHz
Band	600, 700, 850, 900 MHz	1500, 1600, 1700, 1800, 1900, 2000, 2100, 2300, 2500, 2600 MHz
Return Loss	-8.9 dB	-9.2 dB
VSWR	2.6:1	2.4:1
Efficiency	45.0%	53.2%
Peak Gain	2.3 dBi	5.1 dBi
Average Gain	-3.4 dB	-2.8 dB
Frequency Range	3300-5000 MHz	5150-5925 MHz
Band	5200, 5500, 5800 MHz	3300, 3500, 3600, 3700, 4500 MHz
Return Loss	-8.2 dB	-7.5 dB
VSWR	2.7:1	2.5:1
Efficiency	25.7%	28.3%
Peak Gain	2.6 dBi	2.7 dBi
Average Gain	-6.0 dB	-5.5 dB
Impedance	50 Ω	
Polarization	Linear	
Radiation Pattern	Omni-Directional	
Max. Input Power	25 W	

## Features

- 5G NR, Iridium, & GPS/GLONASS/QZSS/Galileo frequency coverage
- Easy mounting: Magnetic/Adhesive Mount
- Iridium Certified
- Low Profile
- High Performance
- Pre-Filtered GNSS
- Ground Plane Independent
- Customizable Cable and Connector
- Dimensions 89 × 76 × 27/30 mm
- IP67, IP69

## Applications

- IoT applications
- Telematic
- Navigation
- Satellite Communications
- LTE applications



Maxtena Inc.  
7361 Calhoun Place, Suite 102  
Rockville, MD 20855  
1-877-629-8362  
info@maxtena.com

[www.maxtena.com](http://www.maxtena.com)

**Cable 2 - Iridium Antenna**

Parameter	Specification
Frequency Range	1616-1627 MHz
Band	1621 MHz
Return Loss	12.5 dB
VSWR	1.6:1
Efficiency	68.1%
Peak Gain	5.2 dBi
Average Gain	-1.8 dB
Impedance	50 Ω
Polarization	RHCP
Radiation Pattern	Hemispherical

**Cable 3 - GNSS Ceramic Active Antenna**

Parameter	Specification	
Frequency Range	1575.42 MHz	1598-1606 MHz
Band	1575 MHz	1602 MHz
Patch Size	25 x 25 x 4 mm	
Return Loss	≤ 15.0 dB	
VSWR	≤ 1.4:1 dB	
Impedance	50 Ω	
Radiation Pattern	Hemispherical	
Polarization	RHCP	
Saw Filter Type	Pre-filter	
Active Gain	28 dB @ 2.7 V	
Noise Figure	1.5 dB Typ	
Voltage	1.5-3.6 V	
Current Consumption	9 mA Typ	
Power Consumption	24.3 W Typ	
ESD Protection	2kV	

**Mechanical Specification**

Parameter	Specification
Antenna Dimensions	89 × 76 × 27/30 mm
Operating Temperature	-40°C to + 85°C
Mounting Type	Magnetic/Adhesive Mount
Connector	SMA-Male Standard (Other Connectors Available)
Cable Type	D302 / D100 Standard
Radome Type	PC+ASA
Radome Color	Black, White
Substance Compliance	RoHS
Certificates	Iridium Certified, IP67, IP69

\*Mounted on 30 x 30 cm Metal Plate



Maxtena Inc.  
 7361 Calhoun Place, Suite 102  
 Rockville, MD 20855  
 1-877-629-8362  
 info@maxtena.com

[www.maxtena.com](http://www.maxtena.com)

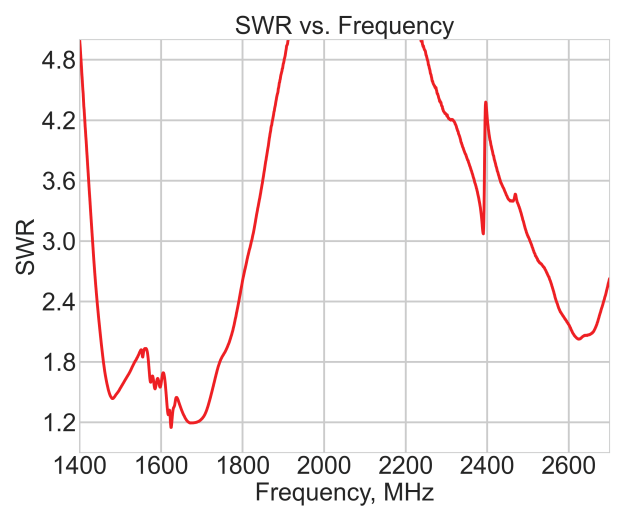
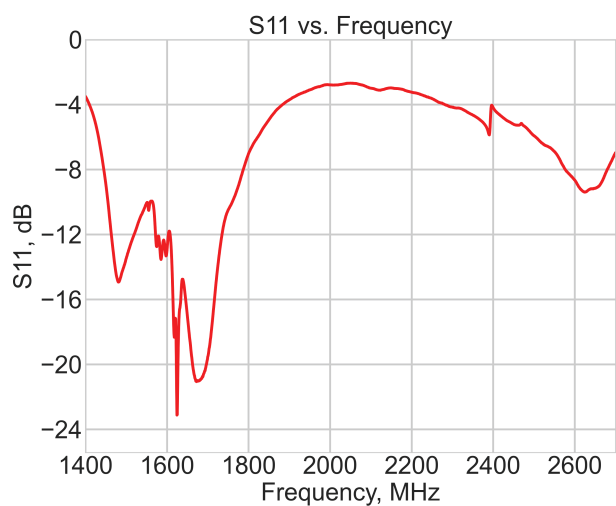
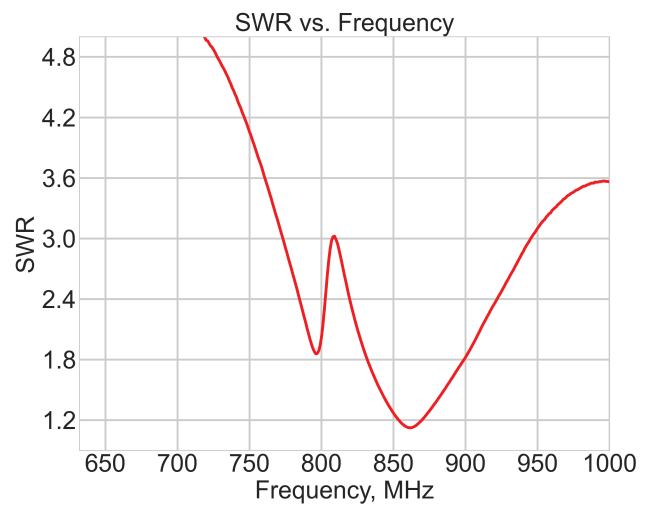
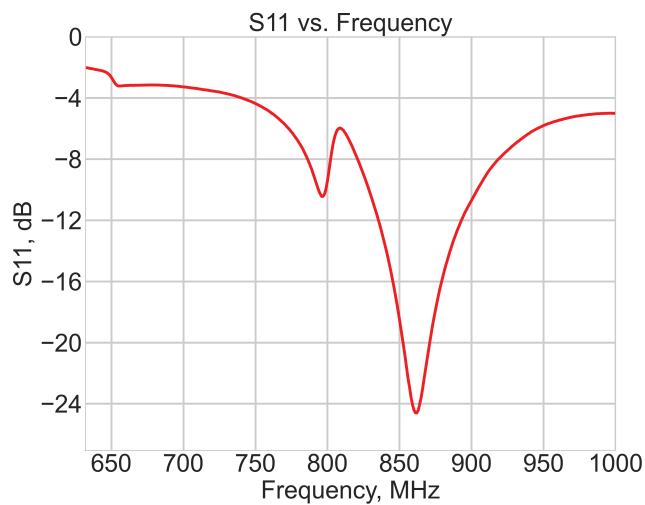
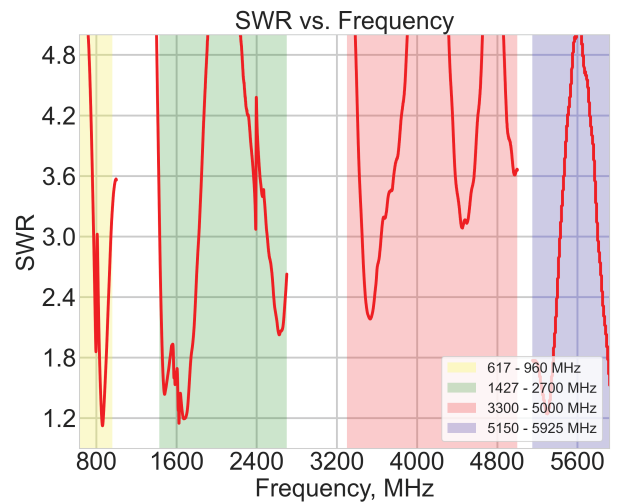
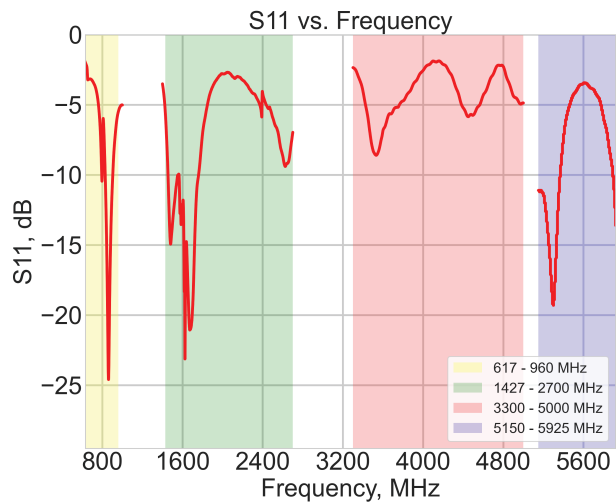

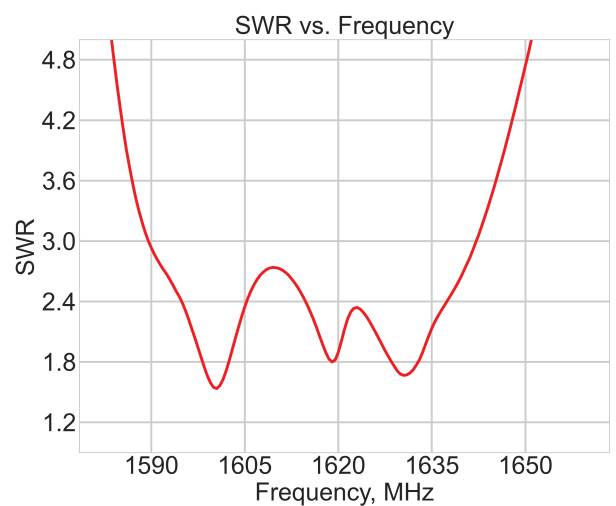
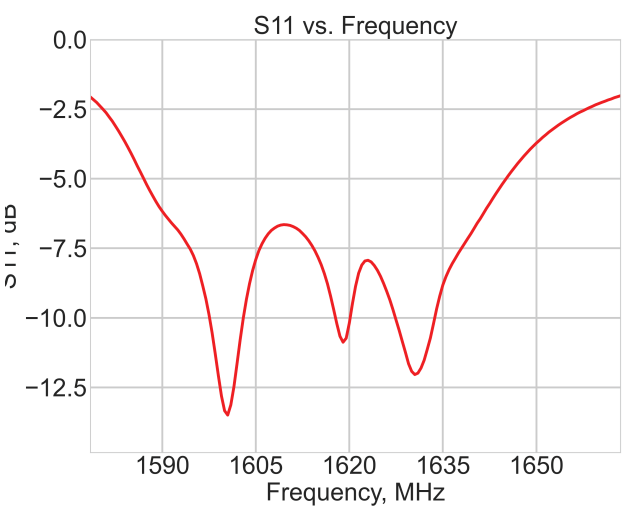
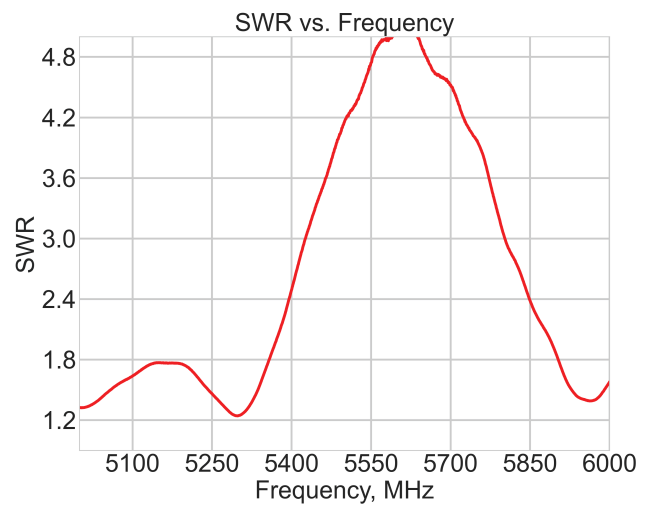
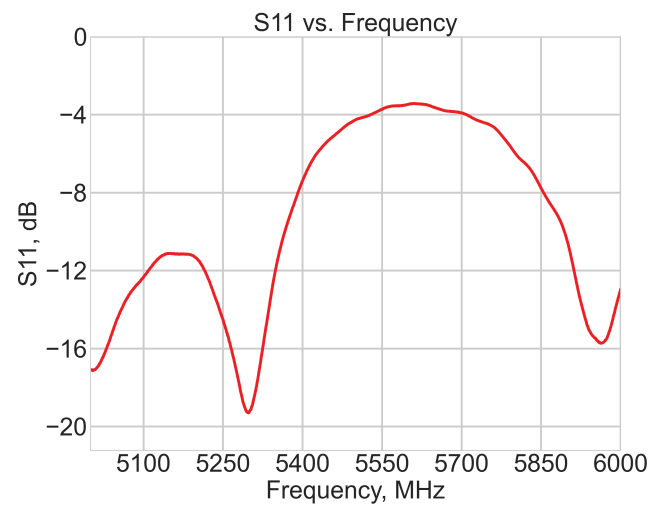
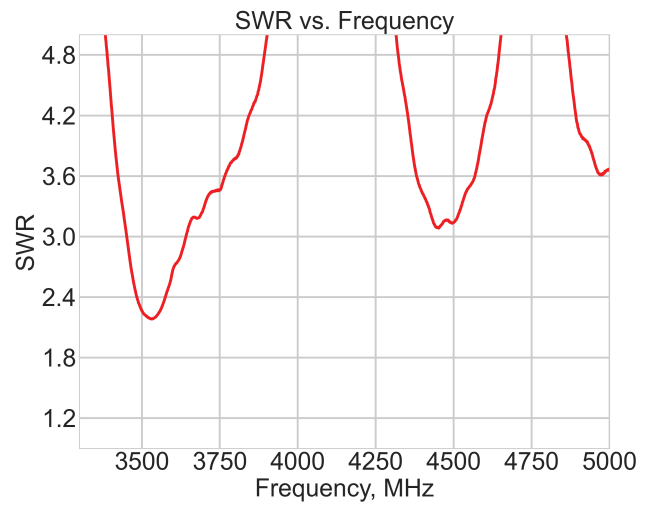
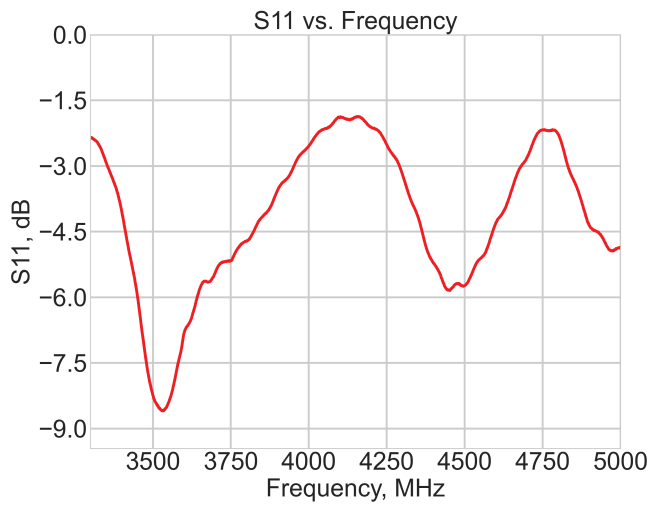

DRAWING REVISION HISTORY			
REV	DESCRIPTION	DATE	BY
A	INITIAL RELEASE	2021-10-08	JET

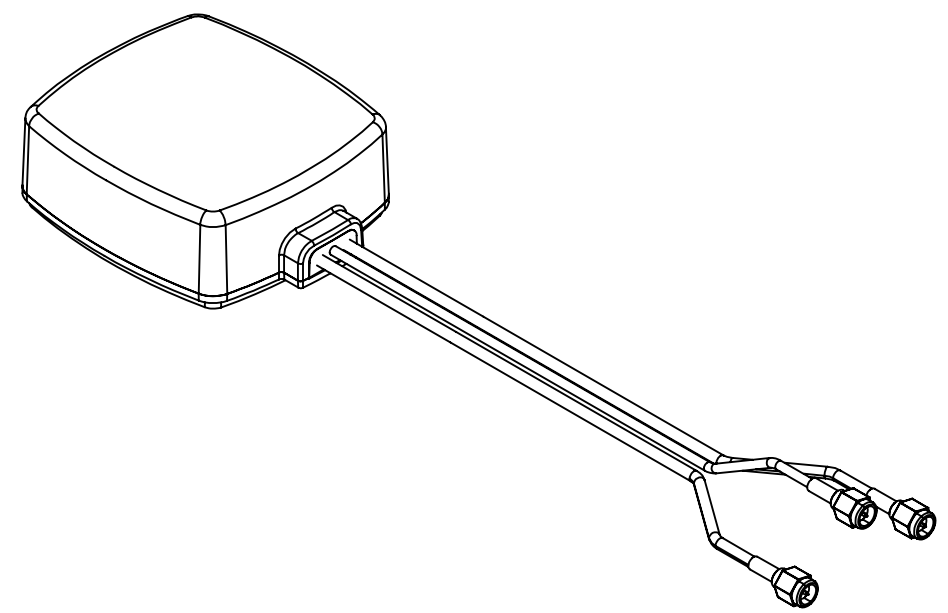
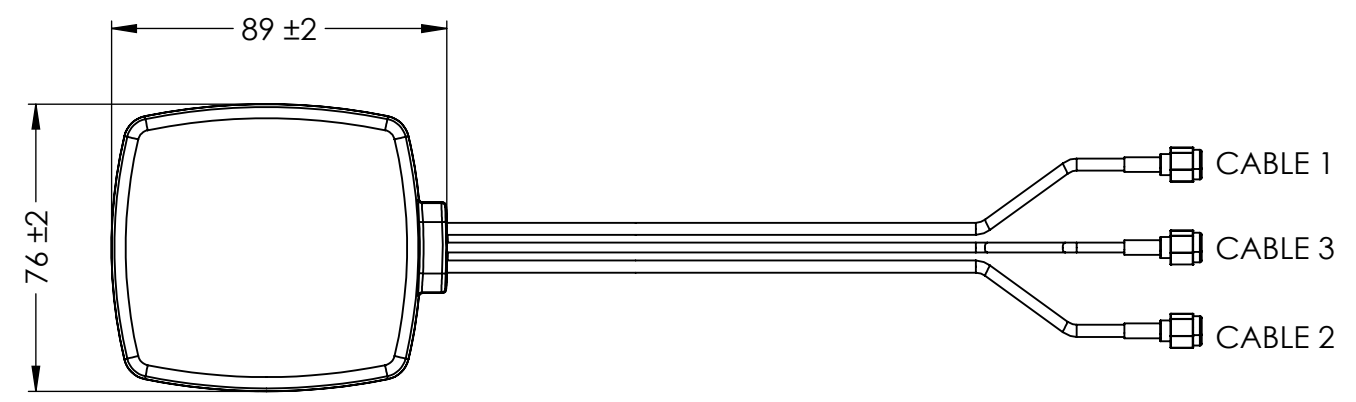

MAGNETIC MOUNT

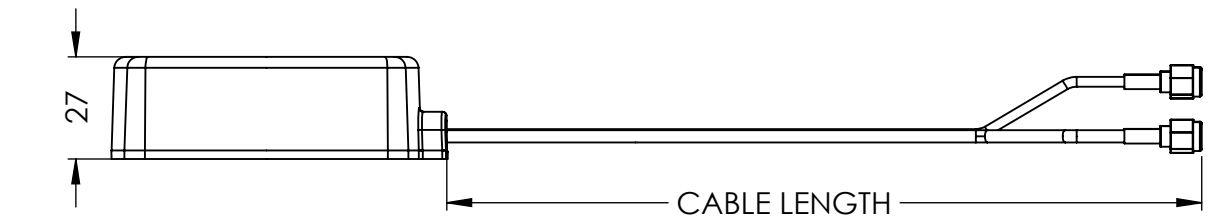

ADHESIVE MOUNT

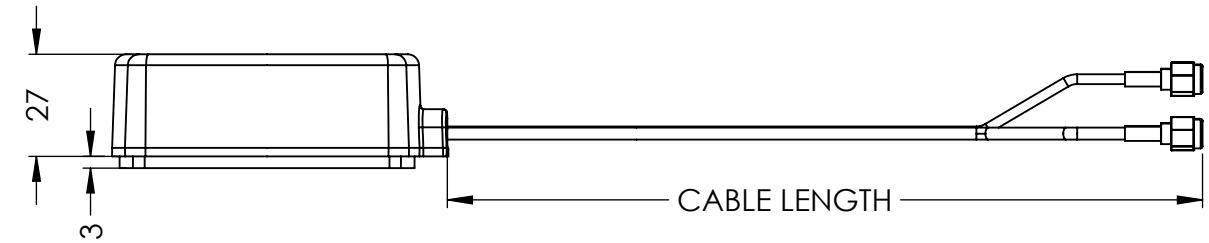

- NOTES:
- FREQUENCY:
    - CABLE 1 (5G NR): 617-960 MHz, 1427-2690 MHz, 3300-5000 MHz, 5150-5925 MHz
    - CABLE 2 (IRIDIUM): 1616-1627 MHz
    - CABLE 3 (GPS/GLONASS/QZSS/GALILEO): 1575.42 MHz, 1598-1606 MHz
  - DIMENSIONS ARE AFTER MOUNTING
  - CUSTOMIZABLE CABLE AND CONNECTOR TYPE
  - MOUNTING TYPE: MAGNETIC/ADHESIVE MOUNT
  - MATERIALS:
    - RADOME: PC + ASA
    - RADOME COLOR: BLACK or WHITE
  - OPERATING TEMPERATURE: -40°C ~ +85°C
  - STORAGE TEMPERATURE: -40°C ~ +85°C
  - CERTIFICATION: IRIDIUM CERTIFIED, IP67, IP69

100-00206-01 CONFIGURATION TABLE				
DASH NO	CABLE TYPE	CABLE LENGTH	CONNECTOR TYPE	RADOME COLOR
-01	CABLE 1: D302 CABLE 2: D302 CABLE 3: LL100	200 CM 200 CM 200 CM	SMA-MALE SMA-MALE SMA-MALE	BLACK

ITEM 100-00206-01 REVISION HISTORY			
REV	DESCRIPTION	DATE	BY
A	INITIAL RELEASE	2021-10-08	JET

UNLESS OTHERWISE SPECIFIED:			NAME		DATE	<b>MAXTENA, INC</b>  TITLE: <b>100-00206-01 ME A-5IG-MA</b>	
DIMENSIONS ARE IN MM			DRAWN	JET	2021-10-08		
TOLERANCES:			CHECKED	ZX	2021-10-08		
FRACTIONAL: ±			ENG APPR.	NPC	2021-10-08		
ANGULAR: MACH ± .5° BEND ±			MFG APPR.				
ONE PLACE DECIMAL ± 1.0			Q.A.				
TWO PLACE DECIMAL ± .50			CAD MAINTAINED. CHANGES SHALL BE INCORPORATED BY THE DESIGN ACTIVITY.				
INTERPRET GEOMETRIC TOLERANCING PER:					SIZE	DWG. NO.	REV
			DO NOT SCALE DRAWING		<b>B</b>	<b>117-00525-01</b>	<b>A</b>
PROPRIETARY AND CONFIDENTIAL THE INFORMATION CONTAINED IN THIS DRAWING IS THE SOLE PROPERTY OF MAXTENA, INC. ANY REPRODUCTION IN PART OR AS A WHOLE WITHOUT THE WRITTEN PERMISSION OF MAXTENA, INC IS PROHIBITED.			CAGE CODE: 5KQH7		SCALE: NONE		SHEET 1 OF 1

8 7 6 5 4 3 2 1

D  
C  
B  
A

D  
C  
B  
A

8 7 6 5 4 3 2 1