

Bandpass Filter 250457B



1. Features

- IF bandpass filter
- Single-ended operation
- Ceramic Surface Mount Device(SMD) Package
- Maximum Storage Temperature Range : -40℃ ~ 85℃
- Electrostatics Sensitive Device (ESD)

2. Package Dimension

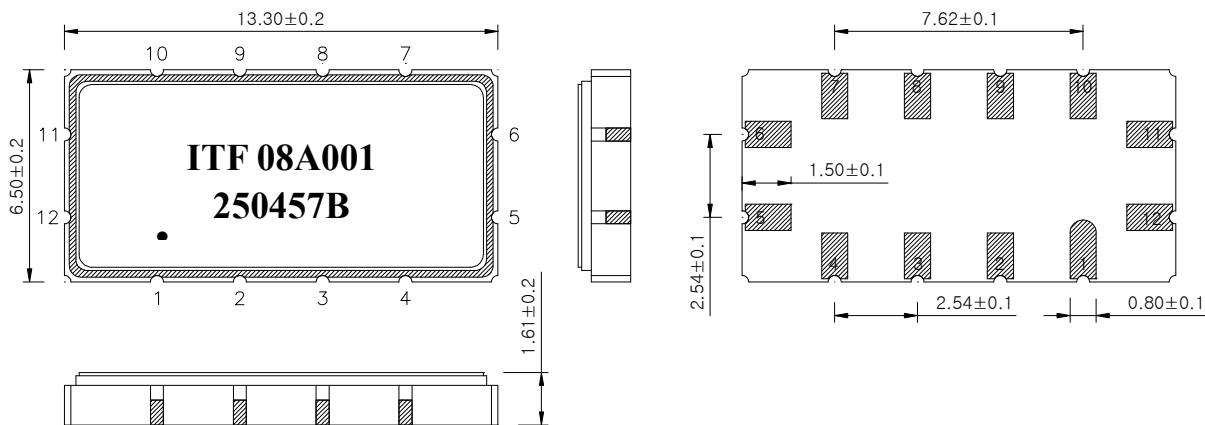

Package : S1365

Dimensions shown are nominal in millimeters

Body : Al₂O₃

Lid : Kovar, Ni Plated

Termination : Au plating 0.3 ~ 1.0um, over a 1.27 ~ 8.89um Ni Plating

Pin Configuration	
11	Input
5	Output
6, 12	Ground
Other	Case ground

	ITF Co., Ltd. 102-901, Bucheon Technopark 364, Samjeong-Dong, Ojeong-Gu, Bucheon-City, Gyeonggi-Do, Korea 421-809	Part No.	250457B	
		Rev. Date	2008-11-18	
		Rev.	NW8034-CS01	1/5

Bandpass Filter 250457B



3. Specifications

Fo = 165.0 MHz

Terminating source impedance : 50Ω and matching network

Terminating load impedance : 50Ω and matching network

Room temperature range : +25°C		Minimum	Typical	Maximum
Center Frequency (Fc)	MHz	-	165.0	-
Insertion Loss	dB	-	22.5	25.0
1dB Bandwidth	MHz	4.2	4.36	-
3dB Bandwidth	MHz	-	4.66	-
40dB Bandwidth	MHz	-	5.9	5.98
Amplitude Ripple (Fo +/- 1.92 MHz)	dB	-	0.5	1.0
Group Delay Variation (Fo +/- 1.92 MHz)	nsec	-	85	130
Absolute Delay	usec	-	1.7	-
Ultimate Rejection	dB	45	50	
Temperature Coefficient of Frequency (TCF)	ppm/°C	-	-0.03	-

Notes :

- 1) All specifications are based on the matching schematic shown below
- 2) All specifications are measured by Agilent Network analyzer and full 2 port calibration
- 3) All attenuation measurements are measured relative to insertion loss

	ITF Co., Ltd. 102-901, Bucheon Technopark 364, Samjeong-Dong, Ojeong-Gu, Bucheon-City, Gyeonggi-Do, Korea 421-809	Part No.	250457B	
		Rev. Date	2008-11-18	
		Rev.	NW8034-CS01	2/5

Bandpass Filter 250457B



4. Matching Schematic

(Actual matching values may vary due to PCB layout and parasitics)

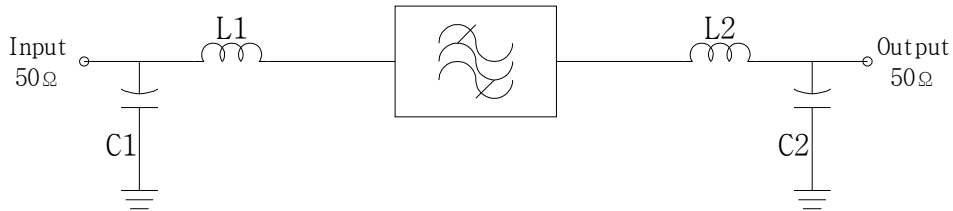

$L1 = 100 \text{ nH}$, $L2 = 82 \text{ nH}$

$C1 = 39 \text{ pF}$, $C2 = 24 \text{ pF}$

5. Marking Configuration

ITF¹⁾ 08A001²⁾

250457B³⁾

● ⁴⁾ 165⁵⁾-4.3M⁶⁾

1) Manufacturer name

2) Lot Number

3) Part Number

4) Pad Number 1 Index

5) Center Frequency

6) 1dB Bandwidth

	ITF Co., Ltd. 102-901, Bucheon Technopark 364, Samjeong-Dong, Ojeong-Gu, Bucheon-City, Gyeonggi-Do, Korea 421-809	Part No.	250457B	
		Rev. Date	2008-11-18	
		Rev.	NW8034-CS01	3/5

Bandpass Filter 250457B



6. Typical Performance (at +25°C)

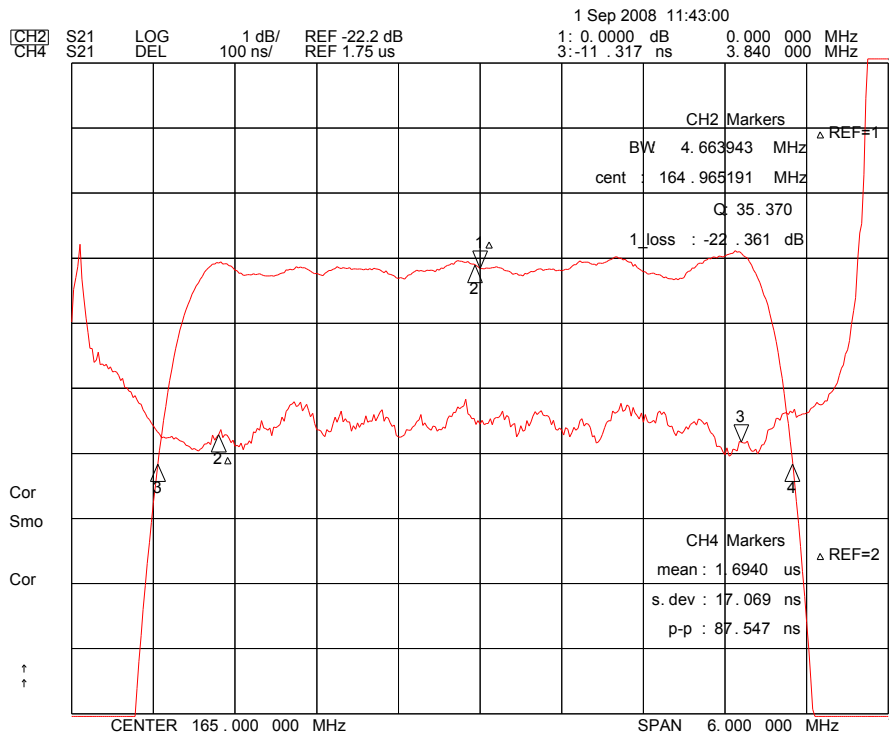
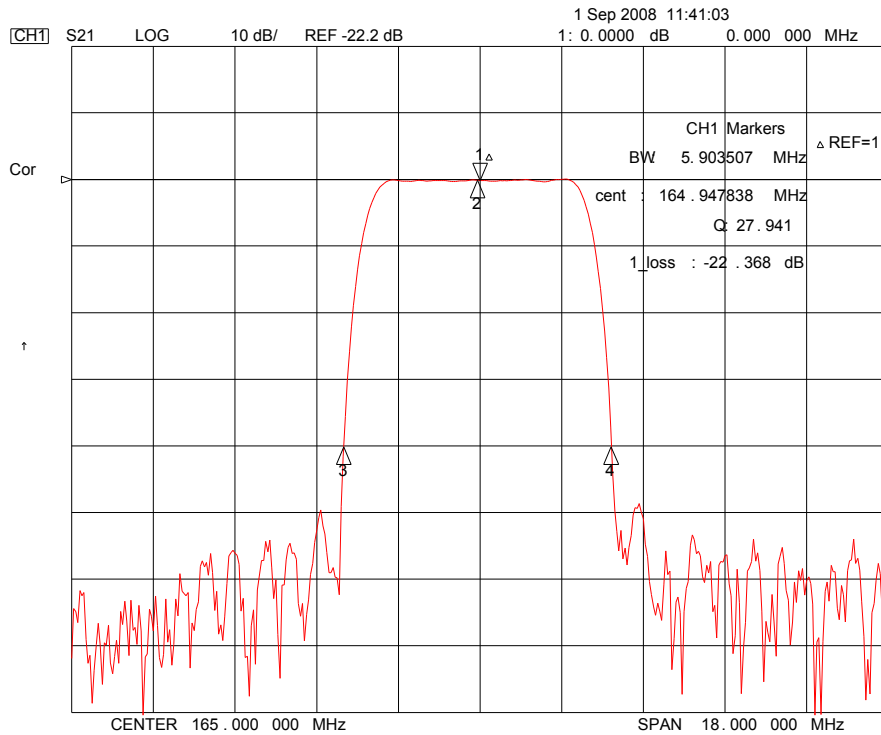

	ITF Co., Ltd. 102-901, Bucheon Technopark 364, Samjeong-Dong, Ojeong-Gu, Bucheon-City, Gyeonggi-Do, Korea 421-809	Part No.	250457B	
		Rev. Date	2008-11-18	
		Rev.	NW8034-CS01	4/5

Bandpass Filter 250457B

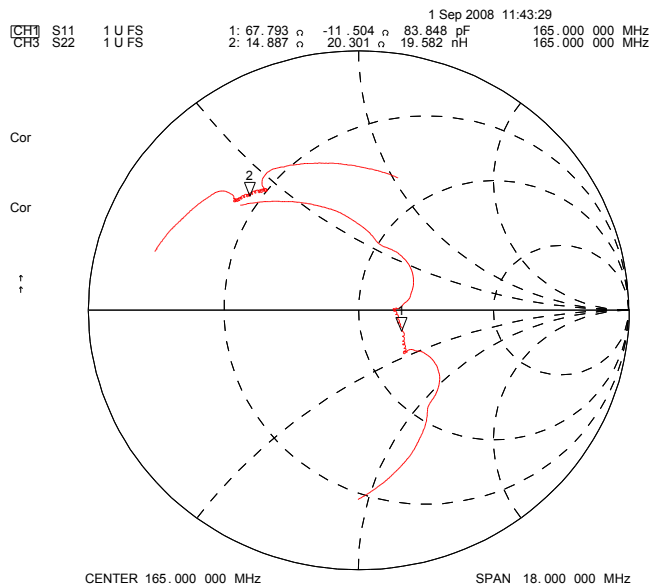
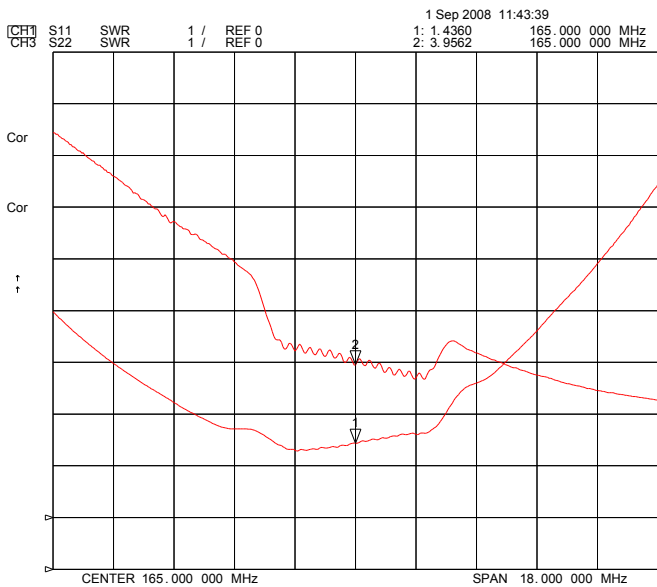
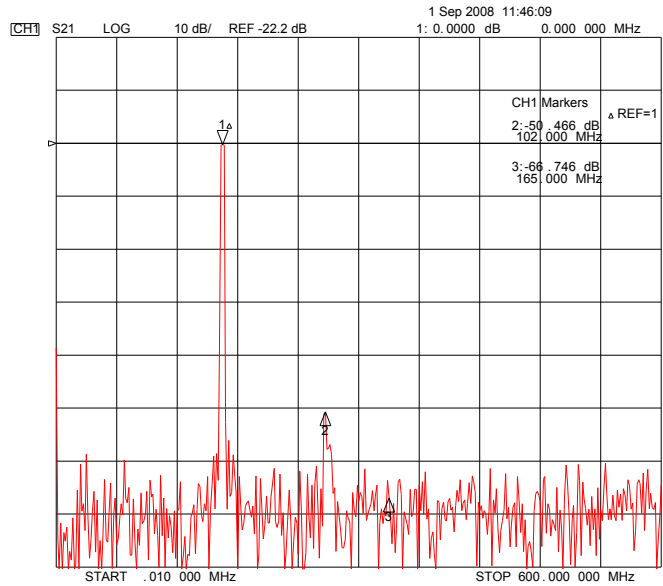
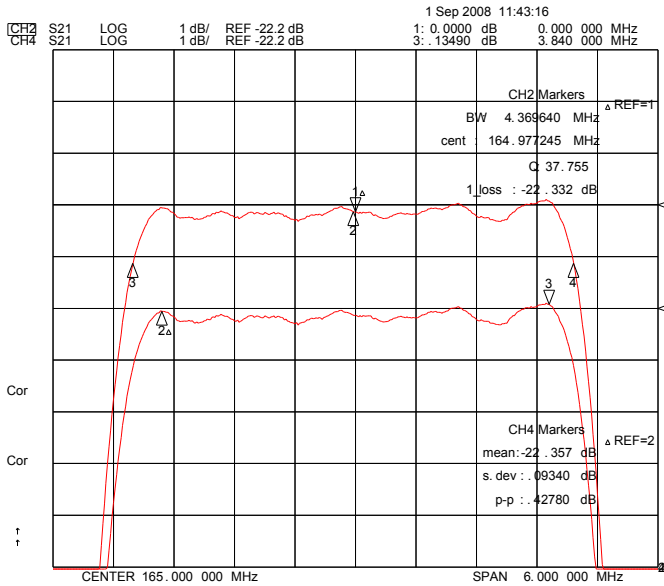

ITF Co., Ltd.
 102-901, Bucheon Technopark 364,
 Samjeong-Dong, Ojeong-Gu, Bucheon-City,
 Gyeonggi-Do, Korea 421-809

Part No.	250457B	
Rev. Date	2008-11-18	
Rev.	NW8034-CS01	5/5