

High Speed Differential ADC Driver Design Considerations

by John Ardizzoni and Jonathan Pearson

INTRODUCTION

Most modern high performance ADCs use differential inputs to reject common-mode noise and interference, increase dynamic range by a factor of 2, and improve overall performance due to balanced signaling. Though ADCs with differential inputs can accept single-ended input signals, optimum ADC performance is achieved when the input signal is differential. ADC drivers—circuits often specifically designed to provide such signals—perform many important functions, including amplitude scaling, single-ended-to-differential conversion, buffering, common-mode offset adjustment, and filtering. Since the introduction of the [AD8138](#), differential ADC drivers have become essential signal conditioning elements in data acquisition systems.

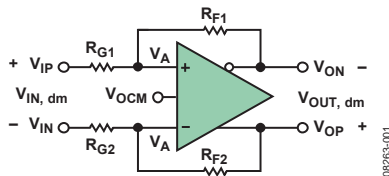

Figure 1. Differential Amplifier

A basic fully differential voltage-feedback ADC driver is shown in Figure 1. Two differences from a traditional op-amp feedback circuit can be seen. The differential ADC driver has an additional output terminal (V_{ON}) and an additional input terminal (V_{OCM}). These terminals provide great flexibility when interfacing signals to ADCs that have differential inputs.

Instead of a single-ended output, the differential ADC driver produces a balanced differential output, with respect to V_{OCM} , between V_{OP} and V_{ON} . (P indicates positive and N indicates negative.) The V_{OCM} input controls the output common-mode voltage. As long as the inputs and outputs stay within their specified limits, the output common-mode voltage must equal the voltage applied to the V_{OCM} input. Negative feedback and high open-loop gain cause the voltages at the amplifier input terminals, V_{A+} and V_{A-} , to be essentially equal.

For the discussions that follow, some definitions are in order. If the input signal is balanced, V_{IP} and V_{IN} are nominally equal in amplitude and opposite in phase with respect to a common reference voltage. When the input is single-ended, one input is at a fixed voltage, and the other varies with respect to it. In either case, the input signal is defined as $V_{IP} - V_{IN}$.

The differential-mode input voltage, $V_{IN,dm}$, and the common-mode input voltage, $V_{IN,cm}$, are defined in Equation 1 and Equation 2.

$$V_{IN,dm} = V_{IP} - V_{IN} \quad (1)$$

$$V_{IN,cm} = \frac{V_{IP} + V_{IN}}{2} \quad (2)$$

This common-mode definition is intuitive when applied to balanced inputs, but it is also valid for single-ended inputs.

The output also has a differential mode and a common mode, defined in Equation 3 and Equation 4.

$$V_{OUT,dm} = V_{OP} - V_{ON} \quad (3)$$

$$V_{OUT,cm} = \frac{V_{OP} + V_{ON}}{2} \quad (4)$$

Note the difference between the actual output common-mode voltage, $V_{OUT,cm}$, and the V_{OCM} input terminal, which establishes the output common-mode level.

The analysis of differential ADC drivers is considerably more complex than that of traditional op amps. To simplify the algebra, it is expedient to define two feedback factors, β_1 and β_2 , as given in Equation 5 and Equation 6.

$$\beta_1 = \frac{R_{G1}}{R_{F1} + R_{G1}} \quad (5)$$

$$\beta_2 = \frac{R_{G2}}{R_{F2} + R_{G2}} \quad (6)$$

Rev. 0

Information furnished by Analog Devices is believed to be accurate and reliable. However, no responsibility is assumed by Analog Devices for its use, nor for any infringements of patents or other rights of third parties that may result from its use. Specifications subject to change without notice. No license is granted by implication or otherwise under any patent or patent rights of Analog Devices. Trademarks and registered trademarks are the property of their respective owners.

TABLE OF CONTENTS

Introduction	1	Noise	7
Revision History	2	Supply Voltage	9
Terminating the Input to an ADC Driver	3	Harmonic Distortion	10
Input Common-Mode Voltage Range (ICMVR).....	5	Bandwidth and Slew Rate.....	11
Input and Output Coupling: AC or DC	6	Stability	11
Output Swing	7	PC Board Layout	12

REVISION HISTORY

11/09—Revision 0: Initial Version

In most ADC driving applications, $\beta_1 = \beta_2$, but the general closed-loop equation for $V_{OUT, dm}$, in terms of V_{IP} , V_{IN} , V_{OCM} , β_1 , and β_2 , is useful to gain insight into how beta mismatch affects performance. The equation for $V_{OUT, dm}$, shown in Equation 7, includes the finite frequency-dependent, open-loop voltage gain of the amplifier, $A(s)$.

$$V_{OUT, dm} = \left[\frac{2}{\beta_1 + \beta_2} \right] \left[\frac{V_{OCM}(\beta_1 - \beta_2) + V_{IP}(1 - \beta_1) - V_{IN}(1 - \beta_2)}{1 + \frac{2}{A(s)(\beta_1 + \beta_2)}} \right] \quad (7)$$

When $\beta_1 \neq \beta_2$, the differential output voltage depends on V_{OCM} , which is an undesirable outcome because it produces an offset and excess noise in the differential output. The gain bandwidth product of the voltage-feedback architecture is constant. Interestingly, the gain in the gain bandwidth product is the reciprocal of the averages of the two feedback factors.

When $\beta_1 = \beta_2 \equiv \beta$, Equation 7 reduces to Equation 8.

$$\frac{V_{OUT, dm}}{V_{IN, dm}} = \left[\frac{R_F}{R_G} \right] \left[\frac{1}{1 + \frac{1}{A(s)(\beta)}} \right] \quad (8)$$

This is a more familiar-looking expression; the ideal closed-loop gain becomes simply R_F/R_G when $A(s) \rightarrow \infty$. The gain bandwidth product is also more familiar looking, with the noise gain equal to $1/\beta$, just as with a traditional op amp.

The ideal closed-loop gain for a differential ADC driver with matched feedback factors is seen in Equation 9.

$$A_V = \frac{V_{OUT, dm}}{V_{IN, dm}} = \frac{R_F}{R_G} \quad (9)$$

Output balance, an important performance metric for differential ADC drivers, has two components: amplitude balance and phase balance. Amplitude balance is a measure of how closely the two outputs are matched in amplitude; in an ideal amplifier, they are exactly matched. Output phase balance is a measure of how close the phase difference between the two outputs is to 180° . Any imbalance in output amplitude or phase produces an undesirable common-mode component in the output. The output balance error (Equation 10) is the log ratio of the output common-mode voltage produced by a differential input signal to the output differential-mode voltage produced by the same input signal, expressed in decibels.

$$\text{Output Balance Error} = 20 \log_{10} \left[\frac{\Delta V_{OUT, cm}}{\Delta V_{OUT, dm}} \right] \quad (10)$$

An internal common-mode feedback loop forces $V_{OUT, cm}$ to equal the voltage applied to the V_{OCM} input, producing excellent output balance.

TERMINATING THE INPUT TO AN ADC DRIVER

ADC drivers are frequently used in systems that process high speed signals. Devices separated by more than a small fraction of a signal wavelength must be connected by electrical transmission lines with controlled impedance to avoid losing signal integrity. Optimum performance is achieved when a transmission line is terminated at both ends in its characteristic impedance. The driver is generally placed close to the ADC, so controlled-impedance connections are not required between them; however, the incoming signal connection to the ADC driver input is often long enough to require a controlled-impedance connection, terminated in the proper resistance.

The input resistance of the ADC driver, whether differential or single-ended, must be greater than or equal to the desired termination resistance so that a termination resistor, R_T , can be added in parallel with the amplifier input to achieve the required resistance. All ADC drivers in the examples considered here are designed to have balanced feedback ratios, as shown in Figure 2.

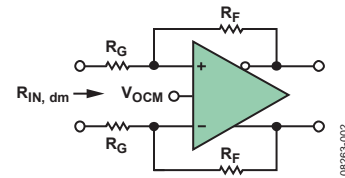

Figure 2. Differential Amplifier Input Impedance

Because the voltage between the two amplifier inputs is driven to a null by negative feedback, they are virtually connected, and the differential input resistance, R_{IN} , is simply $2 \times R_G$. To match the transmission line resistance, R_L , place resistor, R_T , as calculated in Equation 11, across the differential input. Figure 3 shows typical resistances $R_F = R_G = 200 \Omega$, desired $R_{L, dm} = 100 \Omega$, and $R_T = 133 \Omega$.

$$R_T = \frac{1}{\frac{1}{R_L} - \frac{1}{R_{IN}}} \quad (11)$$

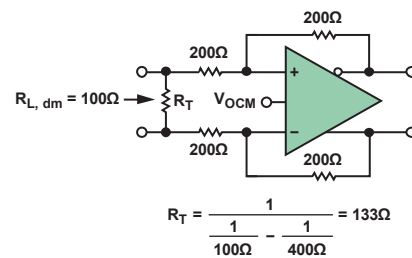

Figure 3. Matching a 100 Ω Line

Terminating a single-ended input requires significantly more effort. Figure 4 illustrates how an ADC driver operates with a single-ended input and a differential output.

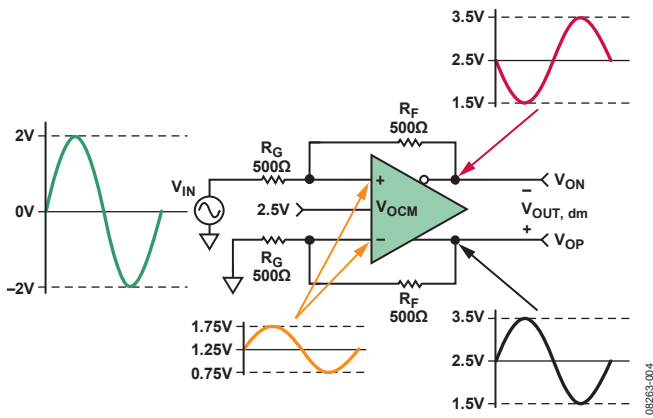

Figure 4. Example of Single-Ended Input to ADC Driver

Although the input is single-ended, $V_{IN, dm}$ is equal to V_{IN} . Because resistors R_F and R_G are equal and balanced, the gain is unity, and the differential output, $V_{OP} - V_{ON}$, is equal to the input, that is, 4 V p-p. $V_{OUT, cm}$ is equal to $V_{OCM} = 2.5$ V and, from the lower feedback circuit, input voltages V_{A+} and V_{A-} are equal to $V_{OP}/2$.

Using Equation 3 and Equation 4, $V_{OP} = V_{OCM} + V_{IN}/2$, an in-phase swing of ± 1 V about 2.5 V. $V_{ON} = V_{OCM} - V_{IN}/2$, an antiphase swing of ± 1 V about 2.5 V. Thus, V_{A+} and V_{A-} swing ± 0.5 V about 1.25 V. The ac component of the current that must be supplied by V_{IN} is $(2\text{ V} - 0.5\text{ V})/500\ \Omega = 3\text{ mA}$, so the resistance to ground that must be matched, looking in from V_{IN} , is 667 Ω .

The general formula for determining this single-ended input resistance when the feedback factors of each loop are matched is shown in Equation 12, where $R_{IN, se}$ is the single-ended input resistance.

$$R_{IN, se} = \left(\frac{R_G}{1 - \frac{R_F}{2 \times (R_G + R_F)}} \right) \quad (12)$$

This is a starting point for calculating the termination resistance. However, it is important to note that amplifier gain equations are based on the assumption of a zero impedance input source. A significant source impedance that must be matched in the presence of an imbalance caused by a single-ended input inherently adds resistance only to the upper R_G . To retain the balance, this must be matched by adding resistance to the lower R_G , but this affects the gain.

Although it may be possible to determine a closed-form solution to the problem of terminating a single-ended signal, an iterative method is generally used. The need for it will become apparent in the following example.

In Figure 5, a single-ended-to-differential gain of 1, a 50 Ω input termination, and feedback and gain resistors with values in the neighborhood of 200 Ω are required to keep noise low.

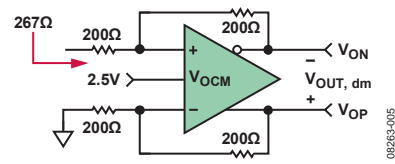

Figure 5. Single-Ended Input Impedance

Equation 12 provides the single-ended input resistance, 267 Ω . Equation 13 indicates that the parallel resistance, R_T , should be 61.5 Ω to bring the 267 Ω input resistance down to 50 Ω .

$$R_T = \frac{1}{\frac{1}{50\ \Omega} - \frac{1}{267\ \Omega}} = 61.5 \quad (13)$$

Figure 6 shows the circuit with source and termination resistances. The open-circuit voltage of the source, with its 50 Ω source resistance, is 2 V p-p. When the source is terminated in 50 Ω , the input voltage is reduced to 1 V p-p, which is also the differential output voltage of the unity-gain driver.

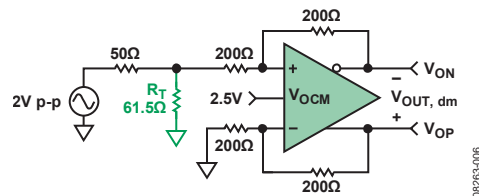

Figure 6. Single-Ended Circuit with Source and Termination Resistances

This circuit may initially appear to be complete, but an unmatched resistance of 61.5 Ω in parallel with 50 Ω has been added to the upper R_G alone. This changes the gain and single-ended input resistance and mismatches the feedback factors. For small gains, the change in input resistance is small and neglected for the moment, but the feedback factors must still be matched. The simplest way to accomplish this is to add resistance to the lower R_G . Figure 7 shows a Thevenin equivalent circuit in which the previously mentioned parallel combination acts as the source resistance.

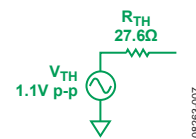

Figure 7. Thevenin Equivalent of Input Source

With this substitution, a 27.6 Ω resistor, R_{TS} , is added to the lower loop to match loop feedback factors, as seen in Figure 8.

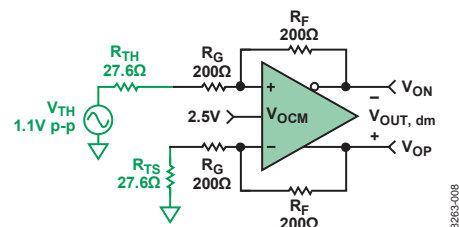

Figure 8. Balanced Single-Ended Termination Circuit

Note that the Thevenin voltage of 1.1 V p-p is larger than the properly terminated voltage of 1 V p-p, and the gain resistors are each increased by 27.6 Ω, decreasing the closed-loop gain. These opposing effects tend to cancel each other out for large resistors (>1 kΩ) and small gains (1 or 2), but are not entirely canceled out for small resistors or higher gains.

The circuit in Figure 8 is now easily analyzed, and the differential output voltage is calculated in Equation 14.

$$V_{OUT, dm} = 1.1 \text{ V p-p} \cdot \left(\frac{200 \Omega}{227.6 \Omega} \right) = 0.97 \text{ V p-p} \quad (14)$$

The differential output voltage is not quite at the desired level of 1 V p-p, but a final independent gain adjustment is available by modifying the feedback resistance as shown in Equation 15.

$$R_F = 227.6 \Omega \left(\frac{\text{Desired } V_{OUT, dm}}{1.1 \text{ V p-p}} \right) =$$

$$227.6 \Omega \left(\frac{1.0 \text{ V p-p}}{1.1 \text{ V p-p}} \right) = 206.9 \Omega \quad (15)$$

Figure 9 shows the completed circuit, implemented with standard 1% resistor values.

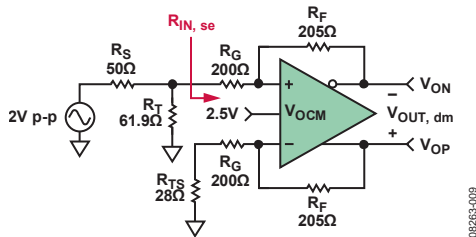

Figure 9. Complete Single-Ended Termination Circuit

Referring to Figure 9, the single-ended input resistance of the driver, $R_{IN, se}$, has changed due to changes in R_F and R_G . The gain resistances of the driver are 200 Ω in the upper loop and $200 \Omega + 28 \Omega = 228 \Omega$ in the lower loop. Calculation of $R_{IN, se}$ with differing gain resistance values first requires two values of beta to be calculated, as shown in Equation 16 and Equation 17.

$$\beta_1 = \frac{R_G}{R_F + R_G} = \frac{200 \Omega}{405 \Omega} = 0.494 \quad (16)$$

$$\beta_2 = \frac{R_G + R_{TS}}{R_F + R_G + R_{TS}} = \frac{228 \Omega}{433 \Omega} = 0.527 \quad (17)$$

The input resistance, $R_{IN, se}$, is calculated as shown in Equation 18.

$$R_{IN, se} = \frac{R_G (\beta_1 + \beta_2)}{\beta_1 (\beta_2 + 1)} = 271 \Omega \quad (18)$$

This differs little from the original calculated value of 267 Ω and does not have a significant effect on the calculation of R_T , because $R_{IN, se}$ is in parallel with R_T .

If a more exact overall gain is necessary, higher precision or series trim resistors can be used.

A single iteration of the method described here works well for closed-loop gains of 1 or 2. For higher gains, the value of R_{TS} gets closer to the value of R_G , and the difference between the value of $R_{IN, se}$ calculated in Equation 18 and that calculated in Equation 12 becomes greater. Several iterations are required for these cases.

This should not be arduous: the recently released differential amplifier calculator tools, ADIsimDiffAmp™ and ADI Diff Amp Calculator™, do all the heavy lifting; they perform the above calculations in a matter of seconds. See www.analog.com for more information.

INPUT COMMON-MODE VOLTAGE RANGE (ICMVR)

ICMVR specifies the range of voltage that can be applied to the differential amplifier inputs for normal operation. The voltage appearing at those inputs can be referred to as ICMV, V_{acm} , or $V_{A\pm}$. This specification is often misunderstood. The most frequent difficulty is determining the actual voltage at the differential amplifier inputs, especially with respect to the input voltage. The amplifier input voltage ($V_{A\pm}$) can be calculated when the variables $V_{IN, cm}$, β , and V_{OCM} are known, using the general Equation 19 for unequal β s or the simplified Equation 20 for equal β s.

$$V_{acm} \text{ or } V_{A\pm} = \frac{2\beta_1\beta_2 V_{OCM} + V_{IP}\beta_2(1-\beta_1) + V_{IN}\beta_1(1-\beta_2)}{\beta_1 + \beta_2} \quad (19)$$

$$V_{acm} \text{ or } V_{A\pm} = V_{IN, cm} + \beta(V_{OCM} - V_{ICM}) \quad (20)$$

Note that V_A is always a scaled-down version of the input signal (as shown in Figure 4). The input common-mode voltage range differs among amplifier types. Analog Devices, Inc., high speed differential ADC drivers have two configurations of input stages, centered and shifted. The centered ADC drivers have about 1 V of headroom from each supply rail (hence centered). The shifted input stages add two transistors to allow the inputs to swing closer to the $-V_S$ rail. Figure 10 shows a simplified input schematic of a typical differential amplifier (Q2 and Q3).

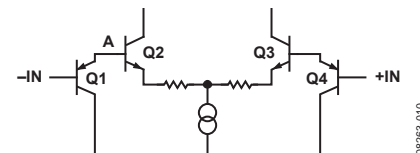

Figure 10. Simplified Differential Amplifier with Shifted ICMVR

The shifted input architecture allows the differential amplifier to process a bipolar input signal, even when the amplifier is powered from a single supply, making it well suited for single-supply applications with inputs at or below ground. The additional PNP transistors (Q1 and Q4) at the input shift the input to the differential pair up by one transistor V_{be} . For example, with -0.3 V applied at $-IN$, Point A is 0.7 V, allowing the differential pair to operate properly. Without the PNPs (centered input stage), -0.3 V at Point A would reverse-bias the NPN differential pair and halt normal operation.

Table 1. High Speed ADC Driver Specifications

ADC Driver				Supply Voltage (V)								Output Swing from Rails (V)	I _{SUPPLY} (mA)
				ICMVR				V _{OCM}					
Part No.	BW (MHz)	Slew Rate (V/μs)	Noise (nV)	±5 V	+5 V	+3.3 V	+3 V	±5 V	+5 V	+3.3 V	+3 V		
AD8132	350	1200	8	-4.7 to +3	0.3 to 3	0.3 to 1.3	0.3 to 1	±3.6	1 to 3.7	N/A	0.3 to 1	±1	12
AD8137	76	450	8.25	-4 to +4	1 to 4	1 to 2.3	1 to 2	±4	1 to 4	1 to 2.3	1 to 2	Rail to rail	3.2
AD8138	320	1150	5	-4.7 to +3.4	0.3 to 3.2	N/A	N/A	±3.8	1 to 3.8	N/A	N/A	±1.4	20
AD8139	410	800	2.25	-4 to +4	1 to 4	N/A	N/A	±3.8	1 to 3.8	N/A	N/A	Rail to rail	25
ADA4927-1/ ADA4927-2	2300	5000	1.4	-3.5 to +3.5	1.3 to 3.7	N/A	N/A	±3.5	1.5 to 3.5	N/A	N/A	±1.2	20
ADA4932-1/ ADA4932-2	1000	2800	3.6	-4.8 to +3.2	0.2 to 3.2	N/A	N/A	±3.8	1.2 to 3.2	N/A	N/A	±1	9
ADA4937-1/ ADA4937-2	1900	6000	2.2	N/A	0.3 to 3	0.3 to 1.2	N/A	N/A	1.2 to 3.8	1.2 to 2.1	N/A	±0.9	40
ADA4938-1/ ADA4938-2	1000	4700	2.6	-4.7 to +3.4	0.3 to 3.4	N/A	N/A	±3.7	1.3 to 3.7	N/A	N/A	±1.2	37
ADA4939-1/ ADA4939-2	1400	6800	2.3	N/A	1.1 to 3.9	0.9 to 2.4	N/A	N/A	1.3 to 3.5	1.3 to 1.9	N/A	±0.8	37

Table 1 provides a quick reference to many specifications of Analog Devices ADC drivers, including which drivers feature a shifted ICMVR and which do not.

INPUT AND OUTPUT COUPLING: AC OR DC

The need for ac or dc coupling can have a significant impact on the choice of a differential ADC driver. The considerations differ between input and output coupling.

An ac-coupled input stage is illustrated in Figure 11.

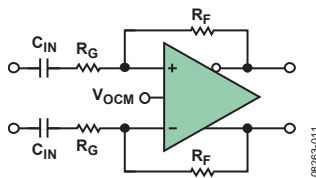

Figure 11. AC-Coupled ADC Driver

For differential-to-differential applications with ac-coupled inputs, the dc common-mode voltage appearing at the amplifier input terminals is equal to the dc output common-mode voltage because dc feedback current is blocked by the input capacitors. Also, the feedback factors at dc are matched and exactly equal to unity. V_{OCM} , and consequently the dc input common mode, is very often set near midsupply. An ADC driver with a centered input common-mode range works well in these types of applications, with the input common-mode voltage near the center of its specified range.

AC-coupled, single-ended-to-differential applications are similar to their differential-input counterparts but have common-mode ripple, a scaled-down replica of the input signal, at the amplifier input terminals. An ADC driver with a centered input common-mode range places the average input common-mode voltage near the middle of its specified range, providing plenty of margin for the ripple in most applications.

When input coupling is optional, it is worth noting that ADC drivers with ac-coupled inputs dissipate less power than similar drivers with dc-coupled inputs because no dc common-mode current flows in either feedback loop.

AC coupling the ADC driver outputs is useful when the ADC requires an input common-mode voltage that differs substantially from that available at the output of the driver. The drivers have maximum output swing when V_{OCM} is set near midsupply; this presents a problem when driving low voltage ADCs with very low input common-mode voltage requirements. A simple solution to this predicament is to ac-couple the connection between the driver output and the ADC input (see Figure 12), removing the dc common-mode voltage of the ADC from the driver output and allowing a common-mode level suitable for the ADC to be applied on its side of the ac coupling. For example, the driver could be running on a single 5 V supply with $V_{OCM} = 2.5$ V and the ADC could be running on a single 1.8 V supply with a required input common-mode voltage of 0.9 V applied at ADC CMV.

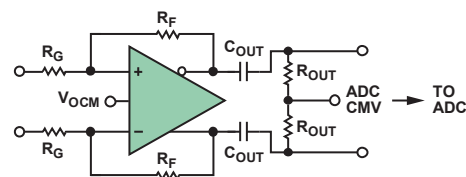

Figure 12. DC-Coupled Inputs with AC-Coupled Outputs

Drivers with shifted input common-mode ranges generally work best in dc-coupled systems operating on single supplies. This is because the output common-mode voltage is divided down through the feedback loops, and its variable components can get close to ground, which is the negative rail. With single-ended inputs, the input common-mode voltage gets even closer to the negative rail due to the input-related ripple.

Systems running on dual supplies, with single-ended or differential inputs and ac coupling or dc coupling, usually work well with either type of input stage because of the increased headroom.

Table 2 summarizes the most common ADC driver input stage types used with various input coupling and power supply combinations. However, these choices may not always be the best; each system should be analyzed on a case-by-case basis.

Table 2. Coupling and Input Stage Options

Input Coupling	Input Signal	Power Supplies	Input Type
Any	Any	Dual	Either
AC	Single-ended	Single	Centered
DC	Single-ended	Single	Shifted
AC	Differential	Single	Centered
DC	Differential	Single	Centered

OUTPUT SWING

To maximize the dynamic range of an ADC, it should be driven to its full input range. However, care is needed when driving the ADC. If the ADC is driven too hard, the input may be damaged; if it is not driven hard enough, resolution is lost. Driving the ADC to its full input range does not mean that the amplifier output must swing to its full range. A major benefit of differential outputs is that each output must swing only half as much as a traditional single-ended output. The driver outputs can stay away from the supply rails, allowing decreased distortion. However, this is not the case for single-ended drivers. As the output voltage of the driver approaches the rail, the amplifier loses linearity and introduces distortion.

For applications where every millivolt of output voltage is required, see Table 1 for ADC drivers that have rail-to-rail outputs with typical headroom ranging from a few millivolts to a few hundred millivolts, depending on the load.

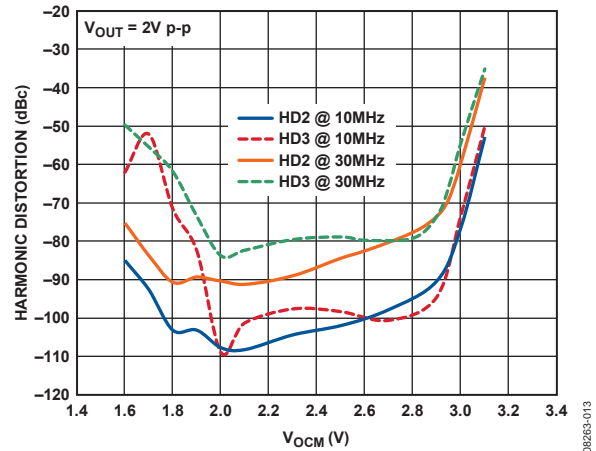

Figure 13. Harmonic Distortion vs. V_{OCM} at Various Frequencies for the ADA4932 with a 5 V Supply

Figure 13 shows harmonic distortion vs. V_{OCM} at various frequencies for the ADA4932, which is specified with a typical output swing to within 1.2 V of each rail (headroom). The output swing is the sum of V_{OCM} and V_{PEAK} of the signal (1 V). Note that the distortion starts to accelerate above 2.8 V (3.8 V_{PEAK} , or 1.2 V below the 5 V rail). At the low end, distortion is still low at 2.2 V ($-1 V_{PEAK}$). The same type of behavior appears in the discussions of bandwidth and slew rate.

NOISE

ADC imperfections include quantization noise, electronic—or random—noise, and harmonic distortion. Important in most applications, noise is usually the most important performance metric in broadband systems.

All ADCs inherently have quantization noise, which depends on the number of bits (n); quantization noise can be decreased by increasing the number of bits (n). Because even ideal converters produce quantization noise, it is used as a benchmark against which to compare random noise and harmonic distortion. The output noise from the ADC driver should be comparable to or lower than the random noise and distortion of the ADC. Beginning with a review of the characterization of ADC noise and distortion, how to weigh ADC driver noise against the performance of the ADC will be shown.

Quantization noise occurs because the ADC quantizes analog signals that have infinite resolution into a finite number of discrete levels. An n-bit ADC has 2^n binary levels. The difference between one level and the next represents the finest difference that can be resolved; it is referred to as a least significant bit (LSB), or q, for the quantum level. One quantum level is therefore $1/2^n$ of the range of the converter. If a varying voltage is converted by a perfect n-bit ADC, then converted back to analog and subtracted from the input of the ADC, the difference looks like noise. It has an rms value of

$$RMS \text{ Quantization Noise} = \frac{q}{\sqrt{12}} = \frac{1}{2^n \sqrt{12}} \tag{21}$$

From this, the logarithmic (dB) formula for the signal-to-quantizing-noise ratio of an n-bit ADC over its Nyquist bandwidth can be derived (Equation 22); it is the best achievable SNR for an n-bit converter.

$$\text{Signal-to-Quantization-Noise Ratio (dB)} = 6.02n + 1.76 \text{ dB} \quad (22)$$

Random noise in ADCs, a combination of thermal, shot, and flicker noise, is generally larger than the quantization noise. Harmonic distortion, resulting from nonlinearities in the ADC, produces unwanted signals in the output that are harmonically related to the input signals. Total harmonic distortion and noise (THD + N) is an important ADC performance metric that compares the electronic noise and harmonic distortion with an analog input that is close to the full-scale input range of the ADC. Electronic noise is integrated over a bandwidth that includes the frequency of the last harmonic to be considered. In Equation 23, the total THD includes the first five harmonic distortion components, which are root-sum-squared along with the noise.

$$\text{THD + Noise} = \frac{\sqrt{[v_2(\text{rms})]^2 + [v_3(\text{rms})]^2 + [v_4(\text{rms})]^2 + [v_5(\text{rms})]^2 + [v_6(\text{rms})]^2 + v_n^2}}{[v_1(\text{rms})]^2} \quad (23)$$

The input signal is v_1 , the first five harmonic distortion products are v_2 through v_6 , and the ADC electronic noise is v_n .

The reciprocal of THD + noise, the signal-to-noise-and-distortion ratio (SINAD) is usually expressed in decibels (Equation 24).

$$\text{SINAD (dB)} = 20 \log_{10} \left[\frac{1}{\text{THD} + N} \right] \quad (24)$$

If SINAD is substituted for the signal-to-quantizing-noise ratio (Equation 22), an effective number of bits (ENOB) that a converter can have if its signal-to-quantizing-noise ratio is the same as its SINAD (Equation 25) can be defined.

$$\text{SINAD (dB)} = 6.02(\text{ENOB}) + 1.76 \text{ dB} \quad (25)$$

ENOB can also be expressed in terms of SINAD as shown in Equation 26.

$$\text{ENOB} = \frac{\text{SINAD (dB)} - 1.76 \text{ dB}}{6.02} \quad (26)$$

ENOB can be used to compare noise performance of an ADC driver with that of the ADC to determine its suitability to drive that ADC. A differential ADC noise model is shown in Figure 14.

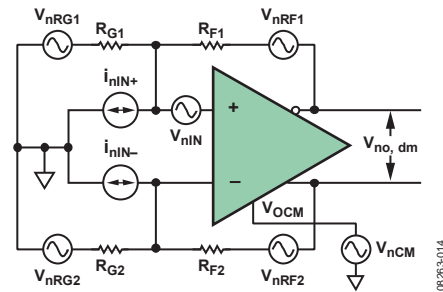

Figure 14. Noise Model of Differential ADC Driver

The contributions to the total output noise density of each of the eight sources are shown in Equation 27 for the general case and when $\beta_1 = \beta_2 = \beta$.

$$\begin{aligned} v_{no, dm} \text{ due to } v_{nIN} &= \frac{2v_{nIN}}{\beta_1 + \beta_2} = \frac{v_{nIN}}{\beta} \text{ for } \beta_1 = \beta_2 = \beta \\ v_{no, dm} \text{ due to } v_{nCM} &= \frac{2v_{nCM}(\beta_1 - \beta_2)}{\beta_1 + \beta_2} = 0 \text{ for } \beta_1 = \beta_2 = \beta \\ v_{no, dm} \text{ due to } i_{nIN+} &= \frac{2i_{nIN+}(1 - \beta_1)R_{G1}}{\beta_1 + \beta_2} = (i_{nIN+})(R_{F1}) \text{ for } \beta_1 = \beta_2 = \beta \\ v_{no, dm} \text{ due to } i_{nIN-} &= \frac{2i_{nIN-}(1 - \beta_2)R_{G2}}{\beta_1 + \beta_2} = (i_{nIN-})(R_{F2}) \text{ for } \beta_1 = \beta_2 = \beta \\ v_{no, dm} \text{ due to } v_{nRG1} &= \frac{(2\sqrt{4kTR_{G1}})(1 - \beta_1)}{\beta_1 + \beta_2} = \sqrt{4kTR_{G1}} \left(\frac{R_{F1}}{R_{G1}} \right) \text{ for } \beta_1 = \beta_2 = \beta \\ v_{no, dm} \text{ due to } v_{nRG2} &= \frac{(2\sqrt{4kTR_{G2}})(1 - \beta_2)}{\beta_1 + \beta_2} = \sqrt{4kTR_{G2}} \left(\frac{R_{F2}}{R_{G2}} \right) \text{ for } \beta_1 = \beta_2 = \beta \\ v_{no, dm} \text{ due to } v_{nRF1} &= \frac{2\beta_1\sqrt{4kTR_{F1}}}{\beta_1 + \beta_2} = \sqrt{4kTR_{F1}} \text{ for } \beta_1 = \beta_2 = \beta \\ v_{no, dm} \text{ due to } v_{nRF2} &= \frac{2\beta_2\sqrt{4kTR_{F2}}}{\beta_1 + \beta_2} = \sqrt{4kTR_{F2}} \text{ for } \beta_1 = \beta_2 = \beta \end{aligned} \quad (27)$$

The total output noise voltage density, $v_{no, dm}$, is calculated by computing the root-sum square of these components. Entering the equations into a spreadsheet is the best way to calculate the total output noise voltage density. The ADI Diff Amp Calculator, which quickly calculates noise, gain, and other differential ADC driver behaviors, is also available at www.analog.com.

ADC driver noise performance can now be compared with the ENOB of an ADC. Take for example, a differential driver with a gain of 2 for the AD9445 ADC on a 5 V supply with a 2 V full-scale input; it processes a direct-coupled broadband signal occupying a 50 MHz (–3 dB) bandwidth, limited with a single-pole filter. From the data sheet listing of the ENOB specifications for various conditions, ENOB = 12 bits for a Nyquist bandwidth of 50 MHz.

The ADA4939 is a high performance, broadband differential ADC driver that can be direct coupled. It is a good candidate to drive the AD9445 with respect to noise. The data sheet recommends $R_F = 402 \Omega$ and $R_G = 200 \Omega$ for a differential gain of approximately 2. A total output voltage noise density for this configuration is $9.7 \text{ nV}/\sqrt{\text{Hz}}$.

First, calculate the system noise bandwidth, B_N , which is the bandwidth of an equivalent rectangular low-pass filter that outputs the same noise power as the actual filter that determines the system bandwidth for a given constant input noise power spectral density. For a one-pole filter, B_N is equal to $\pi/2$ times the 3 dB bandwidth, as shown in Equation 28.

$$B_N = \left(\frac{\pi}{2}\right) 50 \text{ MHz} = 78.5 \text{ MHz} \quad (28)$$

Next, integrate the noise density over the square root of the system bandwidth to obtain the output rms noise (see Equation 29).

$$v_{no, dm} (\text{rms}) = (9.7 \text{ nV}/\sqrt{\text{Hz}})(\sqrt{78.5 \text{ MHz}}) = 86 \mu\text{V rms} \quad (29)$$

The amplitude of the noise is presumed to have a Gaussian distribution; therefore, using the common $\pm 3\sigma$ limits for the peak-to-peak noise (noise voltage swings between these limits about 99.7% of the time), the peak-to-peak output noise is calculated as

$$v_{no, dm} (\text{p-p}) \approx 6(86 \mu\text{V rms}) = 516 \mu\text{V p-p} \quad (30)$$

Now compare the peak-to-peak output noise of the driver with 1 LSB voltage of the AD9445 LSB, based on an ENOB of 12 bits and full-scale input range of 2 V, as calculated in Equation 31.

$$\text{One LSB} = 2 \text{ V}/2^{12} = 488 \mu\text{V} \quad (31)$$

The peak-to-peak output noise from the driver is comparable to the LSB of the ADC with respect to 12 bits of the ENOB; the driver is therefore a good choice to consider in this application from the standpoint of noise. The final determination must be made by building and testing the driver and ADC combination.

SUPPLY VOLTAGE

Considering supply voltage and current is a quick way to narrow the choice of ADC drivers. Table 1 provides a compact reference to ADC driver performance with respect to power supply. The supply voltage influences bandwidth, signal swing, and ICMVR. Weighing the specifications and reviewing the trade-offs are important to differential amplifier selection.

Power-supply rejection (PSR) is another important specification. The role of power supply pins as inputs to the amplifier is often ignored. Any noise on the power supply lines or coupled into them can potentially corrupt the output signal.

For example, consider the ADA4937-1 with 50 mV p-p at 60 MHz of noise on the power line. Its PSR at 50 MHz is –70 dB. This means that the noise on the power supply line reduces to approximately $16 \mu\text{V}$ at the amplifier output. In a 16-bit system with a 1 V full-scale input, 1 LSB is $15.3 \mu\text{V}$; the noise from the power supply line therefore swamps the LSB.

To improve this situation, add series SMT ferrite beads, L1 and L2, and shunt bypass capacitors, C1 and C2 (see Figure 15).

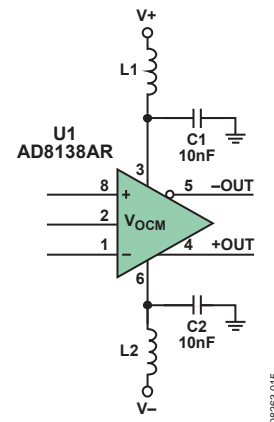

Figure 15. Power Supply Bypassing

At 50 MHz, the ferrite bead has an impedance of 60Ω and the 10 nF ($0.01 \mu\text{F}$) capacitor has an impedance of 0.32Ω . The attenuator formed by these two elements provides 45.5 dB of attenuation (see Equation 32).

$$\text{Divider Attenuation} = 20 \log \left(\frac{0.32}{0.32 + 60} \right) = -45.5 \text{ dB} \quad (32)$$

The divider attenuation combines with the PSR of –70 dB to provide approximately 115 dB of rejection. This reduces the noise to approximately 90 nV p-p , well below 1 LSB.

HARMONIC DISTORTION

Low harmonic distortion in the frequency domain is important in both narrow-band and broadband systems. Nonlinearities in the drivers generate single-tone harmonic distortion and multitone, intermodulation distortion products at amplifier outputs.

The same approach used in the noise analysis example can be applied to distortion analysis, comparing the harmonic distortion of the ADA4939 with 1 LSB of the AD9445's ENOB of 12 bits with a 2 V full-scale output. One ENOB LSB is 488 μ V in the noise analysis.

The distortion data in the specifications table of the ADA4939 is given for a gain of 2, comparing second and third harmonics at various frequencies. Table 3 shows the harmonic distortion data for a gain of 2 and differential output swing of 2 V p-p.

Table 3. Second and Third Harmonic Distortion of the ADA4939

Parameter	Harmonic Distortion (dBc)
HD2 @ 10 MHz	-102
HD2 @ 70 MHz	-83
HD2 @ 100 MHz	-77
HD3 @ 10 MHz	-101
HD3 @ 70 MHz	-97
HD3 @ 100 MHz	-91

The data shows that harmonic distortion increases with frequency and that HD2 is worse than HD3 in the bandwidth of interest (50 MHz). Harmonic distortion products are higher in frequency than the frequency of interest, so their amplitude can be reduced by system band-limiting. If the system had a brick-wall filter at 50 MHz, then only the frequencies higher than 25 MHz are of concern because all harmonics of higher frequencies are eliminated by the filter. Nevertheless, the system was evaluated up to 50 MHz because any filtering that is present may not sufficiently suppress the harmonics, and distortion products can alias back into the signal bandwidth. Figure 16 shows the harmonic distortion vs. frequency of the ADA4939 for various supply voltages with a 2 V p-p output.

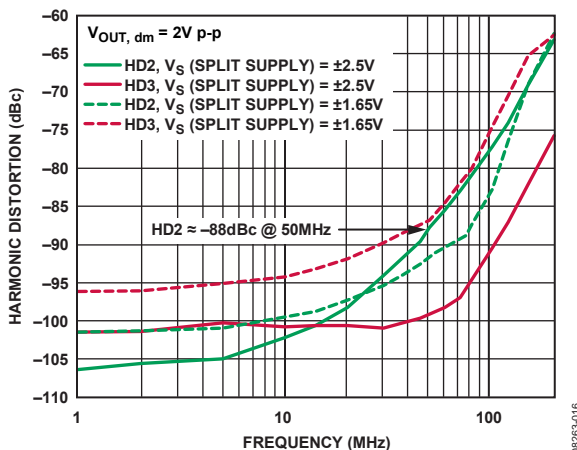

Figure 16. Harmonic Distortion vs. Frequency

The HD2 at 50 MHz is approximately -88 dBc, relative to a 2 V p-p input signal. To compare the harmonic distortion level to 1 ENOB LSB, this level must be converted to a voltage as shown in Equation 33.

$$HD2 = (2 \text{ V p-p}) \left(10^{\frac{-88}{20}} \right) \approx 80 \text{ } \mu\text{V p-p} \quad (33)$$

This distortion product is only 80 μ V p-p, or 16% of 1 ENOB LSB. Thus, from a distortion standpoint, the ADA4939 is a good choice to consider as a driver for the AD9445 ADC.

Because ADC drivers are negative feedback amplifiers, output distortion depends on the amount of loop gain in the amplifier circuit. The inherent open-loop distortion of a negative feedback amplifier is reduced by a factor of $1/(1 + LG)$, where LG is the available loop gain.

The input (error voltage) of the amplifier is multiplied by a large forward voltage gain, $A(s)$, then passes through the feedback factor, β , to the input, where it adjusts the output to minimize the error. Therefore, the loop gain of this type of amplifier is $A(s) \times \beta$; as the loop gain ($A(s)$, β , or both) decreases, harmonic distortion increases. Voltage feedback amplifiers, such as integrators, are designed to have large $A(s)$ at dc and low frequencies, and then roll off as $1/f$ toward unity at a specified high frequency. As $A(s)$ rolls off, loop gain decreases and distortion increases. Therefore, the harmonic distortion characteristic is the inverse of $A(s)$.

Current feedback amplifiers use an error current as the feedback signal. The error current is multiplied by a large forward transresistance, $T(s)$, which converts it to the output voltage, then passes through the feedback factor, $1/R_F$, which converts the output voltage to a feedback current that tends to minimize the input error current. The loop gain of an ideal current feedback amplifier is therefore $T(s) \times (1/R_F) = T(s)/R_F$. Like $A(s)$, $T(s)$ has a large dc value and rolls off with increasing frequency, reducing loop gain and increasing the harmonic distortion.

Loop gain also depends directly upon the feedback factor, $1/R_F$. The loop gain of an ideal current feedback amplifier does not depend on a closed-loop voltage gain; therefore, harmonic distortion performance does not degrade as the closed-loop gain increases. In a real current feedback amplifier, loop gain does have some dependence on the closed-loop gain but not nearly to the extent that it does in a voltage feedback amplifier. This makes a current feedback amplifier, such as the ADA4927, a better choice than a voltage feedback amplifier for applications requiring high closed-loop gain and low distortion.

Figure 17 shows how well distortion performance holds up as the closed-loop gain increases for the ADA4927.

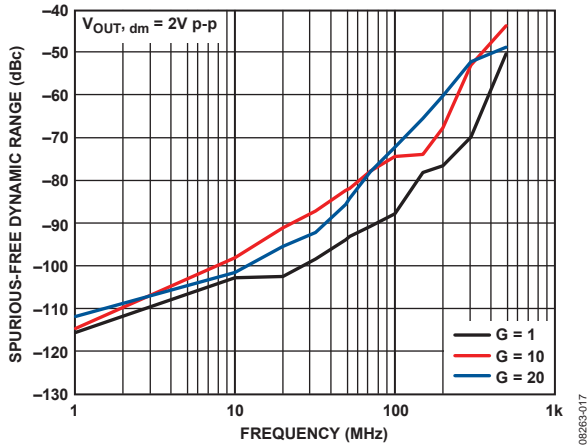

Figure 17. Distortion vs. Frequency and Gain

BANDWIDTH AND SLEW RATE

Bandwidth and slew rate are especially important in ADC driver applications. Typically, the small signal bandwidth is the bandwidth of a device, whereas the slew rate measures the maximum rate of change at the amplifier output for large signal swings.

Effective usable bandwidth (EUBW), an acronym analogous to ENOB, describes bandwidth. Many ADC drivers and op amps boast wide bandwidth specifications; however, not all that bandwidth is usable. For example, -3 dB bandwidth is a conventional way to measure bandwidth, but it does not mean that all the bandwidth is usable. The amplitude and phase errors of the -3 dB bandwidth can be seen a decade earlier than the actual break frequency. An excellent way to determine the usable bandwidth is to consult the distortion plots on the data sheet.

Figure 18 shows that to maintain greater than -80 dBc for second and third harmonics, the ADC driver should not be used for frequencies greater than 60 MHz. Because each application is different, the system requirements are a guide to the appropriate driver with sufficient bandwidth and adequate distortion performance.

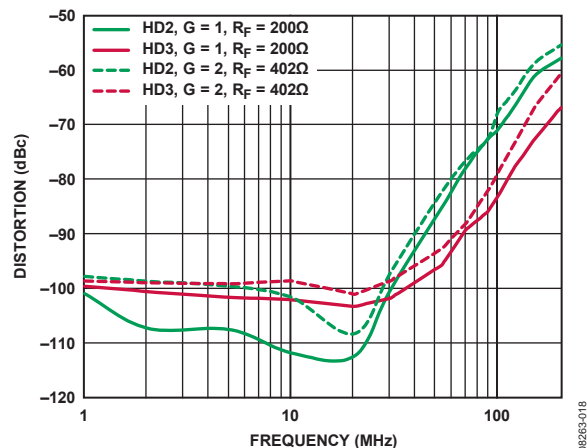

Figure 18. Distortion Curves for ADA4937 Current Feedback ADC Driver

Slew rate (a large signal parameter) refers to the maximum rate of change the amplifier output can track the input, without excessive distortion. Consider the sine wave output at the slew rate.

$$V_O = V_P \sin 2\pi ft \tag{34}$$

The derivative (rate of change) of Equation 34 at the zero crossing, the maximum rate, is

$$\frac{dv}{dt}_{\max} = 2\pi fV_P \tag{35}$$

where:

dv/dt_{\max} is the slew rate.

V_P is the peak voltage.

f is the full power bandwidth (FPBW). Solving for FPBW,

$$FPBW = \frac{Slew\ Rate}{2\pi V_P} \tag{36}$$

Therefore, when selecting an ADC driver, it is important to consider the gain, bandwidth, and slew rate (FPBW) to determine if the amplifier is adequate for the application.

STABILITY

Stability considerations for differential ADC drivers are the same as for op amps. The key specification is phase margin. The phase margin of a particular amplifier configuration can be determined from the data sheets; however, in a real system, parasitic effects in the PC board layout can reduce it significantly.

The stability of a negative voltage, feedback amplifier depends on the magnitude and sign of its loop gain, $A(s) \times \beta$. The differential ADC driver is a bit more complicated than a typical op amp circuit because it has two feedback factors. Loop gain is seen in the denominators of Equation 7 and Equation 8. Equation 37 describes the loop gain for the unmatched feedback factor case ($\beta_1 \neq \beta_2$).

$$Loop\ Gain = \frac{A(s)(\beta_1 + \beta_2)}{2} \tag{37}$$

With unmatched feedback factors, the effective feedback factor is simply the average of the two feedback factors. When they are matched and defined as β , the loop gain simplifies to $A(s) \times \beta$.

For a feedback amplifier to be stable, its loop gain must not be allowed to equal -1 or its equivalent, an amplitude of $+1$ with phase shift of -180° . For a voltage feedback amplifier, the point where the magnitude of loop gain equals 1 (that is, 0 dB) on its open-loop gain frequency plot is where the magnitude of $A(s)$ equals the reciprocal of the feedback factor. For basic amplifier applications, the feedback is purely resistive, introducing no phase shifts around the feedback loop. With matched feedback factors, the frequency independent reciprocal of the feedback factor, $1 + R_F/R_G$, is often referred to as the noise gain. If the constant noise gain in decibels is plotted on the same graph as the open-loop gain, $A(s)$, the frequency where the two curves intersect is where the loop gain is 1, or 0 dB. The difference between the phase of $A(s)$ at that frequency and -180° is defined as the phase margin; for stable operation, it should be greater than or equal to 45° .

Figure 19 illustrates the unity-loop gain point and phase margin for the ADA4932 with $R_F/R_G = 1$ (noise gain = 2).

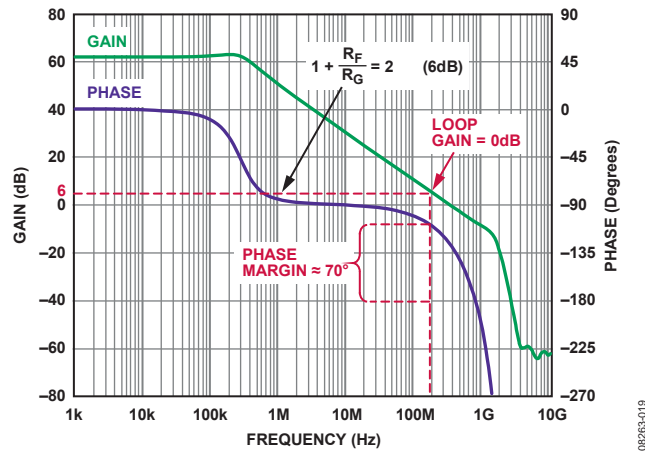

Figure 19. ADA4932 Open-Loop Gain Magnitude and Phase vs. Frequency

Further examination of Figure 19 shows that the ADA4932 has approximately 50° of phase margin at a noise gain of 1 (100% feedback in each loop). Although it is not practical to operate ADC drivers at zero gain, this observation shows that the ADA4932 can operate stably at fractional differential gains (for example, $R_F/R_G = 0.25$, noise gain = 1.25). This is not true for all differential ADC drivers. Minimum stable gains can be seen in all ADC driver data sheets.

Phase margin for current feedback ADC drivers can also be determined from open-loop responses. Instead of forward gain, $A(s)$, current feedback amplifiers use forward transimpedance, $T(s)$, with an error current as the feedback signal. The loop gain of a current feedback driver with matched feedback resistors is $T(s)/R_F$; therefore, the magnitude of the current feedback amplifier loop gain is equal to 1 (that is, 0 dB) when $T(s) = R_F$. This point can be easily located on the open-loop transimpedance and phase plot, in the same way as for the voltage feedback amplifier. Plotting the ratio of a resistance to 1 kΩ allows resistances to be expressed on a log plot. Figure 20 illustrates the unity-loop gain point and phase margin of the ADA4927 current feedback, differential ADC driver with $R_F = 300 \Omega$.

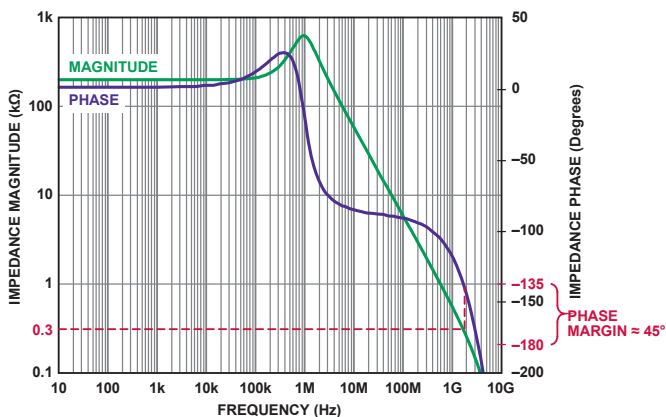

Figure 20. ADA4927 Open-Loop Gain Magnitude and Phase vs. Frequency

The loop gain is 0 dB where the 300 Ω feedback resistance horizontal line intersects the transimpedance magnitude curve. At this frequency, the phase of $T(s)$ is approximately -135° , resulting in a phase margin of $+45^\circ$. Phase margin and stability increase as R_F increases and decrease as R_F decreases. Current feedback amplifiers should always use purely resistive feedback with sufficient phase margin.

PC BOARD LAYOUT

When a stable ADC driver is designed, it must be realized on a PC board. Some phase margin is lost because of the parasitic elements of the board, which must be kept to a minimum. Of particular concern are load capacitance, feedback loop inductance, and summing node capacitance. Each of these parasitic reactances adds lagging phase shift to the feedback loops, thereby reducing phase margin. A design may lose 20° or more of phase margin due to poor PC board layout.

With voltage feedback amplifiers, it is best to use the smallest possible R_F to minimize the phase shift due to the pole formed by R_F and the summing node capacitance. If large R_F is required, that capacitance can compensate with small capacitors, C_F , across each feedback resistor with values such that $R_F C_F$ equals R_G times the summing node capacitance.

PC board layout is necessarily one of the last steps in a design. Unfortunately, it is also one of the most overlooked steps in a design, even though high speed circuit performance is highly dependent on layout. A high performance design can be compromised, or even rendered useless, by a sloppy or poor layout. Although all aspects of proper high speed PC board design cannot be covered here, a few key topics will be addressed.

Parasitic elements rob high speed circuits of performance. Parasitic capacitance is formed by component pads and traces and ground or power planes. Long traces without ground planes form parasitic inductances, which can lead to ringing in transient responses and other unstable behaviors. Parasitic capacitance is especially dangerous at the summing nodes of an amplifier because it introduces a pole in the feedback response, causing peaking and instability. One solution is to make sure that the areas beneath the ADC driver mounting and feedback component pads are clear of ground and power planes throughout all layers of the board.

To minimize undesired parasitic reactances, keep all traces as short as possible. Outer layer 50 Ω PC board traces on FR-4 contribute roughly 2.8 pF/inch and 7 nH/inch. These parasitic reactances increase by about 30% for inner layer 50 Ω traces. Additionally, make sure that there is a ground plane under long traces to minimize trace inductance. Keeping traces short and small helps to minimize both parasitic capacitance and inductance and maintains the integrity of the design.

Power supply bypassing is another key area of concern for layout; make sure that the power supply bypass capacitors, as well as the V_{OCM} bypass capacitor, are located as close to the amplifier pins as possible. In addition, using multiple bypass capacitors on the power supplies helps to ensure that a low impedance path is provided for broadband noise. Figure 21 shows a typical differential amplifier schematic with power supply bypassing and a low-pass filter on the output. The low-pass filter limits the bandwidth and noise entering the ADC. Ideally, the power supply bypassing capacitor returns are close to the load returns; this helps to reduce circulating currents in the ground plane and improves ADC driver performance (see Figure 22).

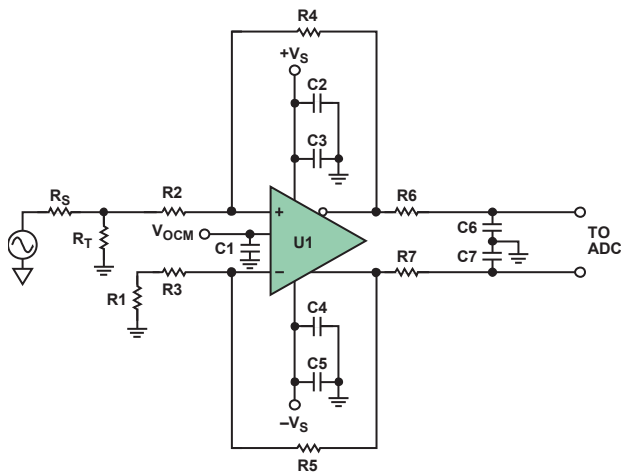

Figure 21. ADC Driver with Power Supply Bypassing and Output Low-Pass Filter

Use of ground plane, and grounding in general, is a detailed and complex subject and beyond the scope of this application note. However, a few key points are as follows (see Figure 22):

- Connect the analog and digital grounds together at one point only. This minimizes the interaction of analog and digital currents flowing in the ground plane, which ultimately leads to noise in the system.
- Terminate the analog power supply into the analog power plane and the digital power supply into the digital power plane.
- For mixed-signal ICs, terminate the analog ground returns into the analog ground plane and the digital ground returns into the digital ground plane and tie the two planes together using only one small connection to minimize the mixing of digital and analog currents (see Figure 23.)

Refer to *A Practical Guide to High-Speed Printed-Circuit-Board Layout* for a detailed discussion about high speed printed circuit board (PCB) layout at www.analog.com.

The information in this application note is intended to help you think about the many considerations that must be taken into account when you design with ADC drivers. Understanding differential amplifiers and paying attention to the details of ADC driver design at the outset of a project minimizes future problems, lowers risk, and ensures a robust design.



Figure 22. Component Side (a), Circuit Side (b)

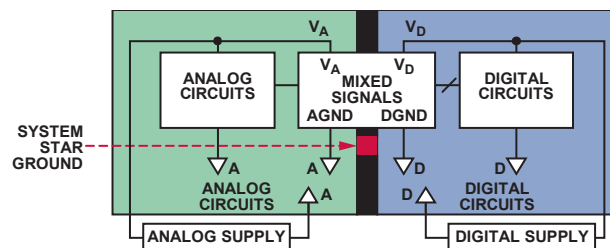

Figure 23. Mixed Signal Grounding

NOTES

NOTES

NOTES