



# 2-and 4-Channel Low Capacitance ESD Protection Arrays

## CM1293A

### Features

- Two and four channels of ESD protection
- Provides ESD protection to IEC61000-4-2
  - $\pm 8\text{kV}$  contact discharge
- Low loading capacitance of 2.0pF max.
- Low clamping voltage
- Channel I/O to I/O capacitance 1.5pF typical
- Zener diode protects supply rail and eliminates the need for external by-pass capacitors
- Each I/O pin can withstand over 1000 ESD strikes\*
- Available in RoHS-compliant, lead-free SOT and MSOP packages

### Applications

- DVI ports, HDMI ports in notebooks, set top boxes, digital TVs, LCD displays
- Serial ATA ports in desktop PCs and hard disk drives
- PCI Express ports
- General purpose high-speed data line ESD protection

### Product Description

The CM1293A family of diode arrays has been designed to provide ESD protection for electronic components or subsystems requiring minimal capacitive loading. These devices are ideal for protecting systems with high data and clock rates or for circuits requiring low capacitive loading. Each ESD channel consists of a pair of diodes in series that steer the positive or negative ESD current pulse to either the positive ( $V_P$ ) or negative ( $V_N$ ) supply rail. A Zener diode is embedded between  $V_P$  and  $V_N$  which helps protect the  $V_{CC}$  rail against ESD strikes. The CM1293A protects against ESD pulses up to  $\pm 8\text{kV}$  contact discharge) per the IEC 61000-4-2 Level 4 standard.

This device is particularly well-suited for protecting systems using high-speed ports such as USB2.0, IEEE1394 (Firewire®, iLink™), Serial ATA, DVI, HDMI, and corresponding ports in removable storage, digital camcorders, DVD-RW drives and other applications where extremely low loading capacitance with ESD protection are required in a small package footprint.

The CM1293A family of devices is available with RoHS-compliant, lead-free finishing.

### Block Diagram

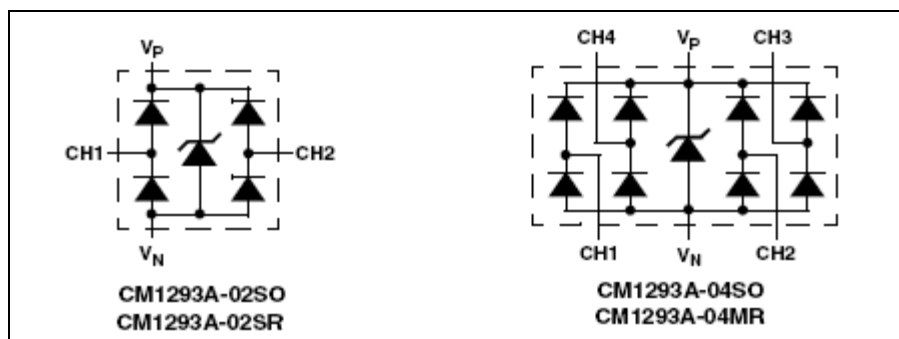

\*Standard test condition is IEC61000-4-2 level 4 test circuit with each pin subjected to  $\pm 8\text{kV}$  contact discharge for 1000 pulses. Discharges are timed at 1 second intervals and all 1000 strikes are completed in one continuous test run. The part is then subjected to standard production test to verify that all of the tested parameters are within spec after the 1000 strikes.

## PACKAGE / PINOUT DIAGRAMS

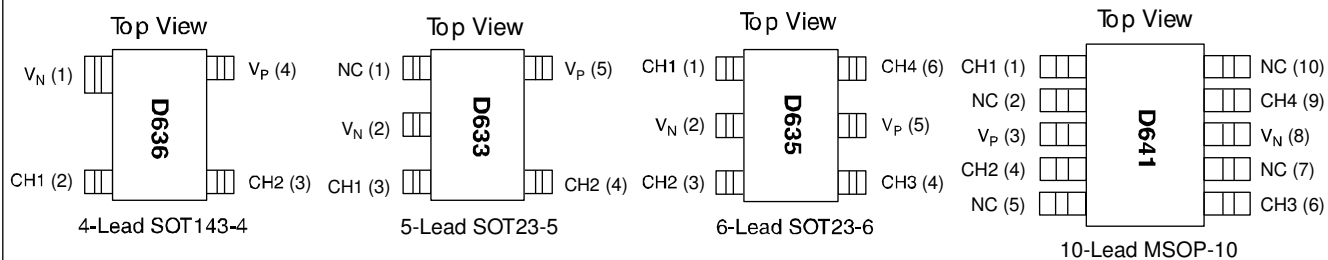

Note: These drawings are not to scale.

## PIN DESCRIPTIONS

2-CHANNEL, 4-LEAD SOT143-4 PACKAGE				2-CHANNEL, 5-LEAD SOT23-5 PACKAGE			
PIN	NAME	TYPE	DESCRIPTION	PIN	NAME	TYPE	DESCRIPTION
1	$V_N$	GND	Negative voltage supply rail	1	NC		No connect
2	CH1	I/O	ESD Channel	2	$V_N$	GND	Negative voltage supply rail
3	CH2	I/O	ESD Channel	3	CH1	I/O	ESD Channel
4	$V_P$	PWR	Positive voltage supply rail	4	CH2	I/O	ESD Channel
				5	$V_P$	PWR	Positive voltage supply rail
4-CHANNEL, 10-LEAD MSOP-10 PACKAGE				4-CHANNEL, 6-LEAD SOT23-6 PACKAGE			
PIN	NAME	TYPE	DESCRIPTION	PIN	NAME	TYPE	DESCRIPTION
1	CH1	I/O	ESD Channel	1	CH1	I/O	ESD Channel
2	NC		No connect	2	$V_N$	GND	Negative voltage supply rail
3	$V_P$	PWR	Positive voltage supply rail	3	CH2	I/O	ESD Channel
4	CH2	I/O	ESD Channel	4	CH3	I/O	ESD Channel
5	NC		No connect	5	$V_P$	PWR	Positive voltage supply rail
6	CH3	I/O	ESD Channel	6	CH4	I/O	ESD Channel
7	NC		No connect				
8	$V_N$	GND	Negative voltage supply rail				
9	CH4	I/O	ESD Channel				
10	NC		No connect				

# CM1293A

## Ordering Information

### PART NUMBERING INFORMATION

# of Channels	Leads	Package	Lead-free Finish	
			Ordering Part Number <sup>1</sup>	Part Marking
2	4	SOT143-4	CM1293A-02SR	D636
2	5	SOT23-5	CM1293A-02SO	D633
4	6	SOT23-6	CM1293A-04SO	D635
4	10	MSOP-10	CM1293A-04MR	D641

Note 1: Parts are shipped in Tape & Reel form unless otherwise specified.

## Specifications

### ABSOLUTE MAXIMUM RATINGS

PARAMETER	RATING	UNITS
Operating Supply Voltage ( $V_P - V_N$ )	6.0	V
Operating Temperature Range	-40 to +85	°C
Storage Temperature Range	-65 to +150	°C
DC Voltage at any channel input	( $V_N - 0.5$ ) to ( $V_P + 0.5$ )	V

### STANDARD OPERATING CONDITIONS

PARAMETER	RATING	UNITS
Operating Temperature Range	-40 to +85	°C
Package Power Rating		
SOT143-4 Package (CM1293A-02SR)	225	mW
SOT23-5 Package (CM1293A-02SO)	225	mW
SOT23-6 Package (CM1293A-04SO)	225	mW
MSOP-10 Package (CM1293A-04MR)	400	mW

Specifications (cont'd)

ELECTRICAL OPERATING CHARACTERISTICS <sup>1</sup>						
SYMBOL	PARAMETER	CONDITIONS	MIN	TYP	MAX	UNITS
$V_P$	Operating Supply Voltage ( $V_P-V_N$ )			3.3	5.5	V
$I_P$	Operating Supply Current	$(V_P-V_N)=3.3V$			8.0	$\mu A$
$V_F$	Diode Forward Voltage Top Diode Bottom Diode	$I_F = 8mA; T_A=25^\circ C$	0.60 0.60	0.80 0.80	0.95 0.95	V V
$I_{LEAK}$	Channel Leakage Current	$T_A=25^\circ C; V_P=5V, V_N=0V$		$\pm 0.1$	$\pm 1.0$	$\mu A$
$C_{IN}$	Channel Input Capacitance	At 1 MHz, $V_P=3.3V, V_N=0V, V_{IN}=1.65V$			2.0	pF
$\Delta C_{IO}$	Channel I/O to I/O capacitance			1.5		pF
$V_{ESD}$	ESD Protection Peak Discharge Voltage at any channel input, in system Contact discharge per IEC 61000-4-2 standard	Notes 3 and 4; $T_A=25^\circ C$		$\pm 8$		kV
$V_{CL}$	Channel Clamp Voltage Positive Transients Negative Transients	$I_{PP}=1A, t_p=8/20\mu s; T_A=25^\circ C; \text{Notes 4}$		+9.9 -1.6		V V
$R_{DYN}$	Dynamic Resistance Positive Transients Negative Transients	$I_{PP}=1A, t_p=8/20\mu s; T_A=25^\circ C; \text{Notes 4}$		0.96 0.5		$\Omega$ $\Omega$

Note 1: All parameters specified at  $T_A = -40^\circ C$  to  $+85^\circ C$  unless otherwise noted.

Note 2: Human Body Model per MIL-STD-883, Method 3015,  $C_{Discharge} = 100pF, R_{Discharge} = 1.5K\Omega, V_P = 3.3V, V_N$  grounded.

Note 3: Standard IEC 61000-4-2 with  $C_{Discharge} = 150pF, R_{Discharge} = 330\Omega, V_P = 3.3V, V_N$  grounded.

Note 4: These measurements performed with no external capacitor on  $V_P$ .

## Performance Information

### Input Channel Capacitance Performance Curves

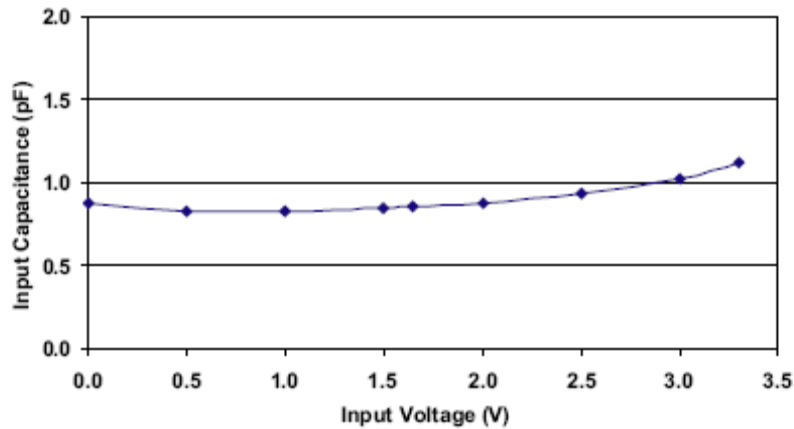

### Typical Variation of $C_{IN}$ vs. $V_{IN}$

( $f=1\text{MHz}$ ,  $V_P = 3.3\text{V}$ ,  $V_N = 0\text{V}$ ,  $0.1\ \mu\text{F}$  chip capacitor between  $V_P$  and  $V_N$ ,  $25^\circ\text{C}$ )

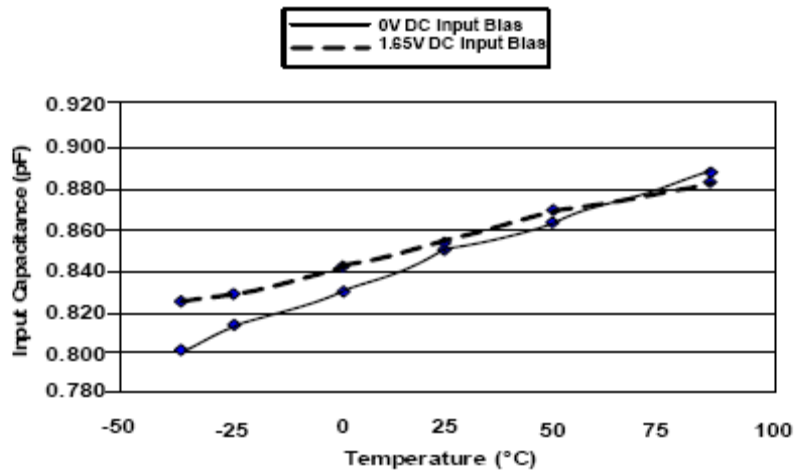

### Typical Variation of $C_{IN}$ vs. Temp

( $f=1\text{MHz}$ ,  $V_{IN}=30\text{mV}$ ,  $V_P = 3.3\text{V}$ ,  $V_N = 0\text{V}$ ,  $0.1\ \mu\text{F}$  chip capacitor between  $V_P$  and  $V_N$ )

## Performance Information (cont'd)

Typical Filter Performance (nominal conditions unless specified otherwise, 50 Ohm Environment)

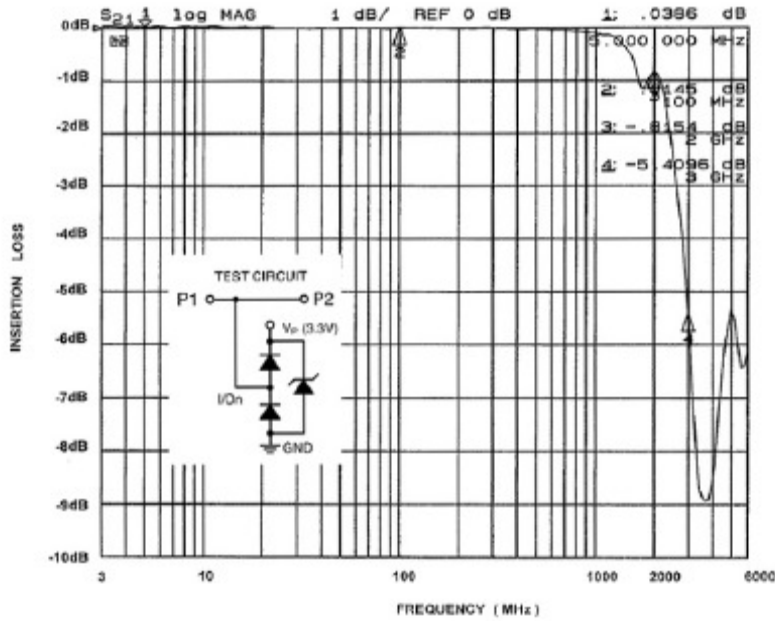

Figure 1. Insertion Loss (S21) VS. Frequency (0V DC Bias,  $V_p=3.3V$ )

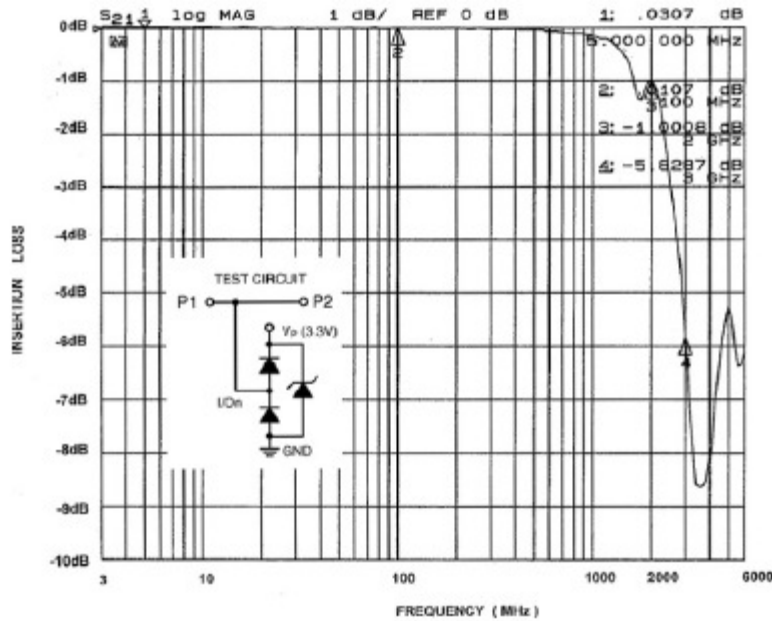

Figure 2. Insertion Loss (S21) VS. Frequency (2.5V DC Bias,  $V_p=3.3V$ )

## Application Information

### Design Considerations

In order to realize the maximum protection against ESD pulses, care must be taken in the PCB layout to minimize parasitic series inductances on the Supply/Ground rails as well as the signal trace segment between the signal input (typically a connector) and the ESD protection device. Refer to [Figure 3](#), which illustrates an example of a positive ESD pulse striking an input channel. The parasitic series inductance back to the power supply is represented by  $L_1$  and  $L_2$ . The voltage  $V_{CL}$  on the line being protected is:

$$V_{CL} = \text{Fwd voltage drop of } D_1 + V_{SUPPLY} + L_1 \times d(I_{ESD}) / dt + L_2 \times d(I_{ESD}) / dt$$

where  $I_{ESD}$  is the ESD current pulse, and  $V_{SUPPLY}$  is the positive supply voltage.

An ESD current pulse can rise from zero to its peak value in a very short time. As an example, a level 4 contact discharge per the IEC61000-4-2 standard results in a current pulse that rises from zero to 30 Amps in 1ns. Here  $d(I_{ESD})/dt$  can be approximated by  $\Delta I_{ESD} / \Delta t$ , or  $30 / (1 \times 10^{-9})$ . So just 10nH of series inductance ( $L_1$  and  $L_2$  combined) will lead to a 300V increment in  $V_{CL}$ !

Similarly for negative ESD pulses, parasitic series inductance from the  $V_N$  pin to the ground rail will lead to drastically increased negative voltage on the line being protected.

The CM1293 has an integrated Zener diode between  $V_P$  and  $V_N$ . This greatly reduces the effect of supply rail inductance  $L_2$  on  $V_{CL}$  by clamping  $V_P$  at the breakdown voltage of the Zener diode. However, for the lowest possible  $V_{CL}$ , especially when  $V_P$  is biased at a voltage significantly below the Zener breakdown voltage, it is recommended that a 0.22 $\mu$ F ceramic chip capacitor be connected between  $V_P$  and the ground plane.

As a general rule, the ESD Protection Array should be located as close as possible to the point of entry of expected electrostatic discharges. The power supply bypass capacitor mentioned above should be as close to the  $V_P$  pin of the Protection Array as possible, with minimum PCB trace lengths to the power supply, ground planes and between the signal input and the ESD device to minimize stray series inductance.

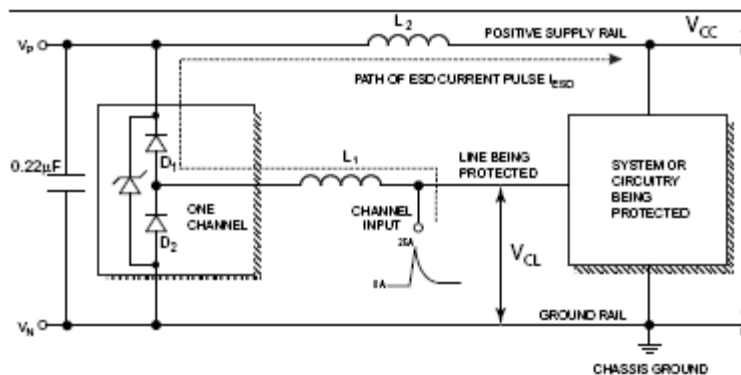

Figure 3. Application of Positive ESD Pulse between Input Channel and Ground

## Mechanical Details

### SOT143 Mechanical Specifications

Dimensions for CM1293A-02SR devices supplied in 4-pin SOT143 packages are presented below.

PACKAGE DIMENSIONS				
Package	SOT143			
Pins	4			
Dimensions	Millimeters		Inches	
	Min	Max	Min	Max
A	0.80	1.22	0.031	0.048
A1	0.05	0.15	0.002	0.006
b	0.30	0.50	0.012	0.019
b2	0.76	0.89	0.030	0.035
c	0.08	0.20	0.003	0.008
D	2.80	3.04	0.110	0.119
E	2.10	2.64	0.082	0.103
E1	1.20	1.40	0.047	0.055
e	1.92 BSC		0.075 BSC	
e1	0.20 BSC		0.008 BSC	
L	0.4	0.6	0.016	0.024
L1	0.54 REF		0.021 REF	
# per tape and reel	3000 pieces			
Controlling dimension: millimeters				

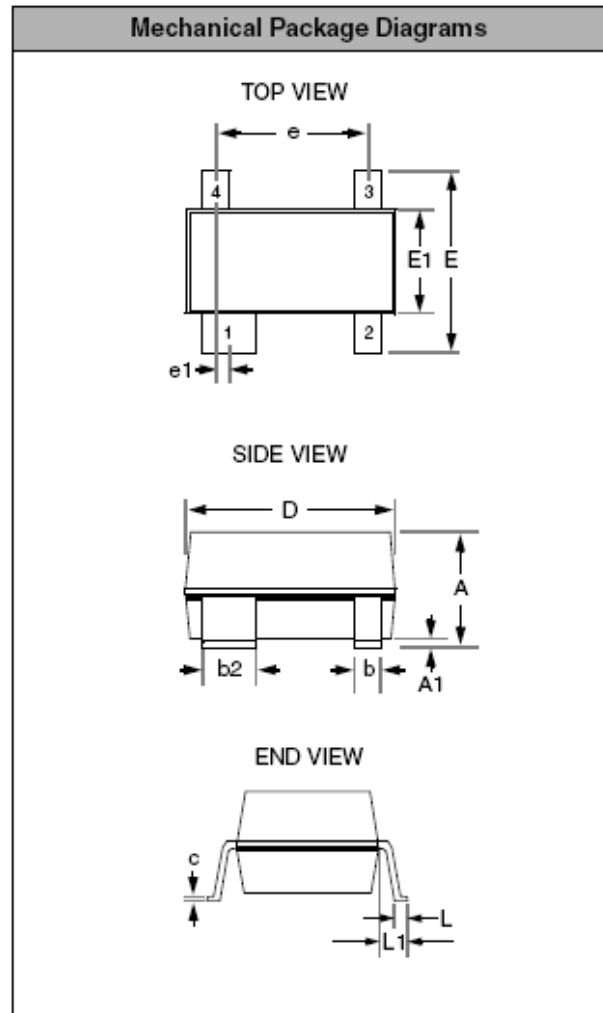

Package Dimensions for SOT143



# CM1293A

## Tape and Reel Specifications

PART NUMBER	PACKAGE SIZE (mm)	POCKET SIZE (mm) $B_o \times A_o \times K_o$	TAPE WIDTH W	REEL DIAMETER	QTY PER REEL	$P_o$	$P_1$
CM1293A-02SR	2.92 X 2.37 X 1.01	2.60 X 3.15 X 1.20	8mm	178mm (7")	3000	4mm	4mm

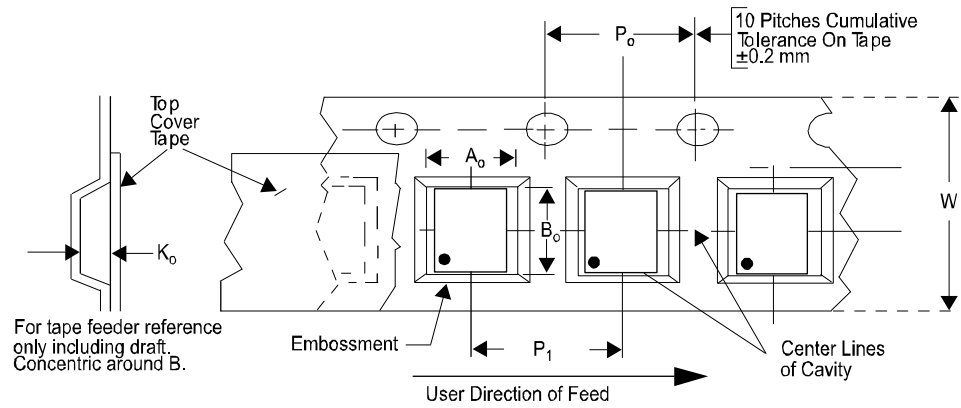

## Mechanical Details (cont'd)

### SOT23-5 Mechanical Specifications, 5 pin

The 5-pin SOT23 package dimensions are presented below.

PACKAGE DIMENSIONS						
Package	SOT23-5					
JEDEC No.	MO-178 (Var. AA)					
Leads	5					
Dim.	Millimeters			Inches		
	Min	Nom	Max	Min	Nom	Max
A	1.14	1.24	1.35	0.045	0.049	0.053
A1	0.05	0.10	0.15	0.002	0.004	0.006
A2	1.09	1.14	1.19	0.043	0.045	0.047
b	0.30	0.35	0.40	0.012	0.014	0.016
c	0.08	0.15	0.22	0.003	0.006	0.009
D	2.87	2.92	2.97	0.113	0.115	0.117
E	2.67	2.79	2.92	0.105	0.110	0.115
E1	1.55	1.63	1.68	0.061	0.064	0.066
e	0.95 REF			0.037 REF		
e1	1.90 REF			0.075 REF		
L	0.35	0.40	0.45	0.014	0.016	0.018
L1	0.53	0.58	0.64	0.021	0.023	0.025
# per tape and reel	3000 pieces					
Controlling dimension: millimeters						

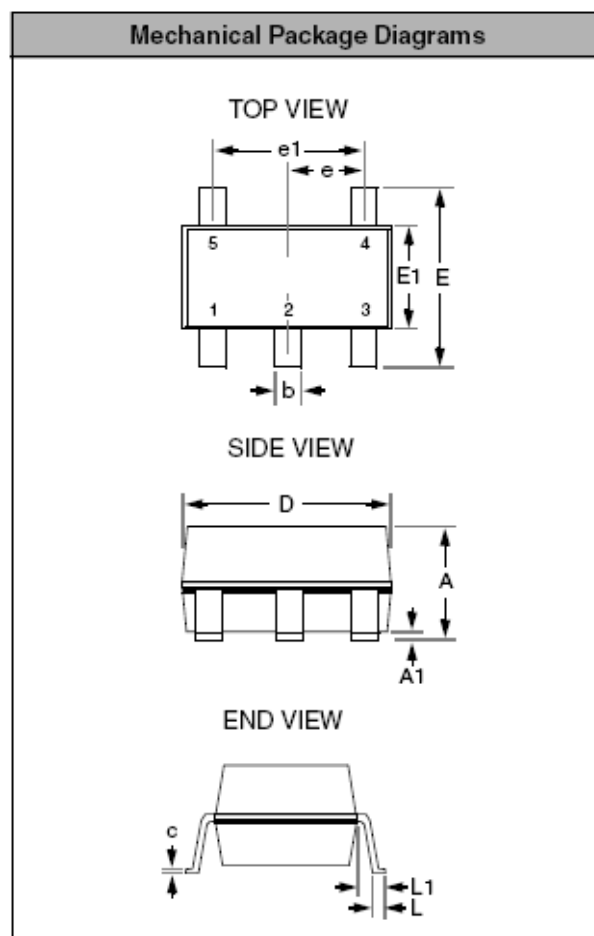

Package Dimensions for SOT23-5

# CM1293A

## Tape and Reel Specifications

PART NUMBER	PACKAGE SIZE (mm)	POCKET SIZE (mm) $B_o \times A_o \times K_o$	TAPE WIDTH W	REEL DIAMETER	QTY PER REEL	$P_o$	$P_1$
CM1293A-02SO	2.92 X 2.79 X 1.24	3.20 X 3.20 X 1.40	8mm	178mm (7")	3000	4mm	4mm

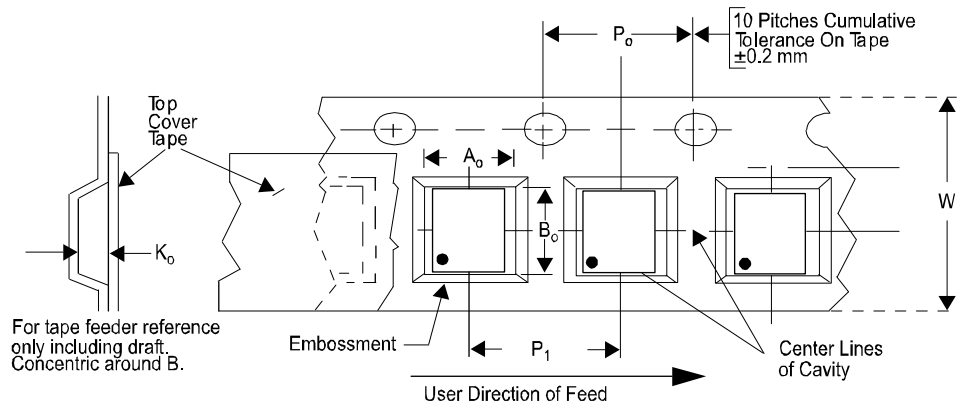

## Mechanical Details (cont'd)

### SOT23-6 Mechanical Specifications

The CM1293A-04SO is supplied in a 6-pin SOT23 package. Dimensions are presented below.

PACKAGE DIMENSIONS				
Package	SOT23-6 (JEDEC name is MO-178)			
Pins	6			
Dimensions	Millimeters		Inches	
	Min	Max	Min	Max
A	--	1.45	--	0.0571
A1	0.00	0.15	0.0000	0.0059
b	0.30	0.50	0.0118	0.0197
c	0.08	0.22	0.0031	0.0087
D	2.75	3.05	0.1083	0.1201
E	2.60	3.00	0.1024	0.1181
E1	1.45	1.75	0.0571	0.0689
e	0.95 BSC		0.0374 BSC	
e1	1.90 BSC		0.0748 BSC	
L	0.30	0.60	0.0118	0.0236
L1	0.60 REF		0.0236 REF	
# per tape and reel	3000 pieces			
Controlling dimension: millimeters				

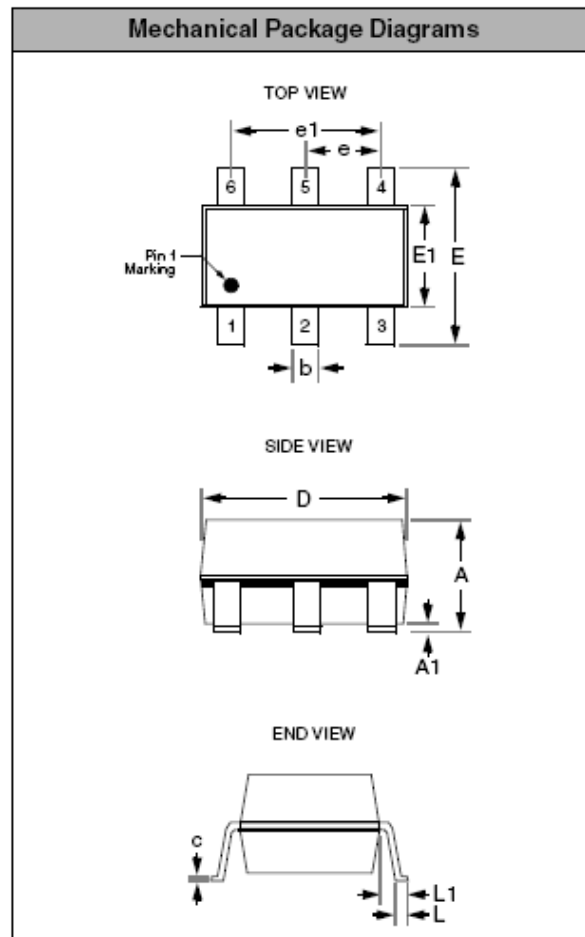

Package Dimensions for SOT23-6

# CM1293A

## Tape and Reel Specifications

PART NUMBER	PACKAGE SIZE (mm)	POCKET SIZE (mm) $B_o \times A_o \times K_o$	TAPE WIDTH W	REEL DIAMETER	QTY PER REEL	$P_o$	$P_1$
CM1293A-04SO	2.90 X 2.80 X 1.45	3.20 X 3.20 X 1.40	8mm	178mm (7")	3000	4mm	4mm

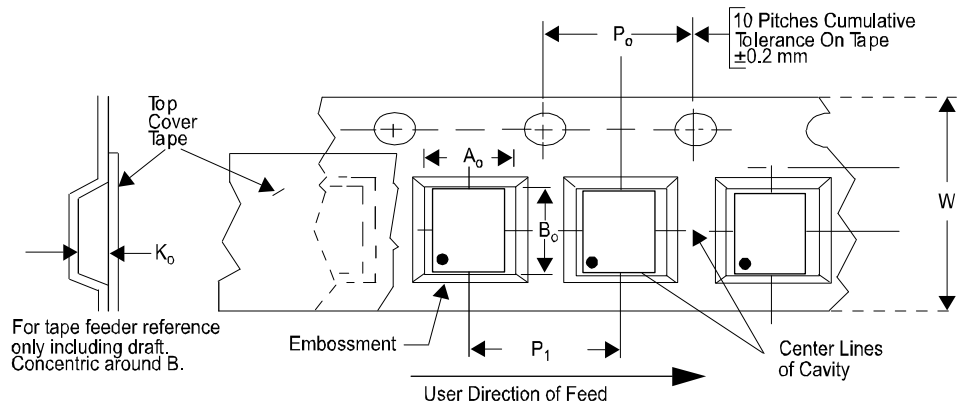

## Mechanical Details (cont'd)

### MSOP-10 Mechanical Specifications

The CM1293A-04MR is supplied in a 10-pin MSOP package. Dimensions are presented below.

PACKAGE DIMENSIONS				
Package	MSOP			
Pins	10			
Dimensions	Millimeters		Inches	
	Min	Max	Min	Max
A	0.75	0.95	0.028	0.038
A1	0.05	0.15	0.002	0.006
B	0.17	0.27	0.007	0.013
C	0.13	0.23	0.005	0.009
D	2.90	3.10	0.114	0.122
E	2.90	3.10	0.114	0.122
e	0.50 BSC		0.0196 BSC	
H	4.90 BSC		0.193 BSC	
L	0.40	0.70	0.0137	0.029
# per tape and reel	4000			
Controlling dimension: millimeters				

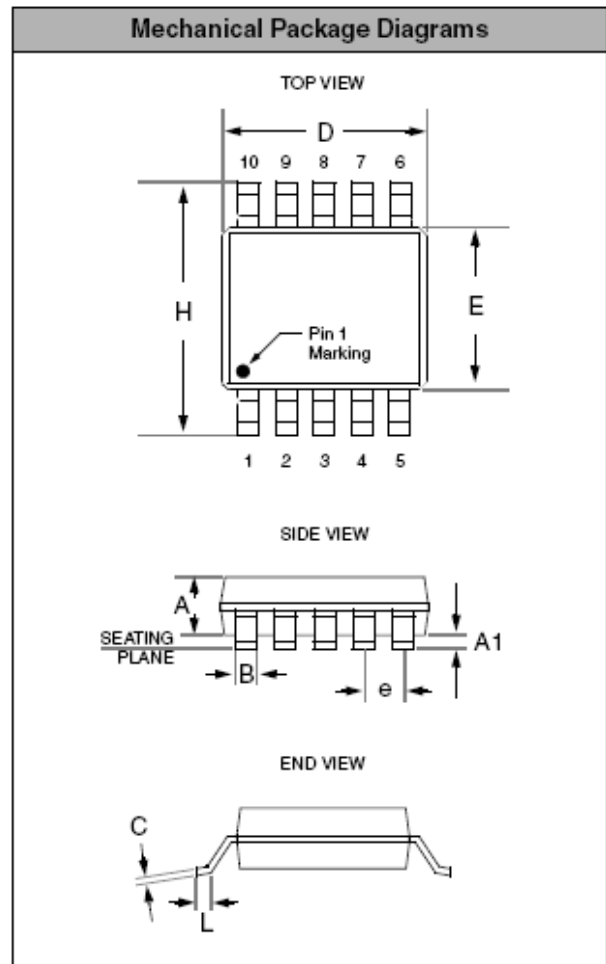



Package Dimensions for MSOP-10

# CM1293A

## Tape and Reel Specifications

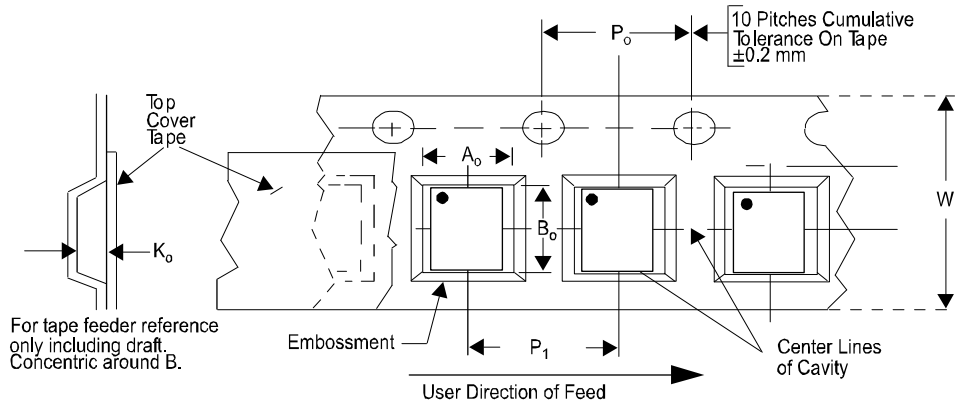
PART NUMBER	PACKAGE SIZE (mm)	POCKET SIZE (mm) $B_o \times A_o \times K_o$	TAPE WIDTH W	REEL DIAMETER	QTY PER REEL	$P_o$	$P_1$
CM1293A-04MR	3.00 X 3.00 X 0.85	3.30 X 5.30 X 1.30	12mm	330mm (13")	4000	4mm	8mm



ON Semiconductor and  are registered trademarks of Semiconductor Components Industries, LLC (SCILLC). SCILLC reserves the right to make changes without further notice to any products herein. SCILLC makes no warranty, representation or guarantee regarding the suitability of its products for any particular purpose, nor does SCILLC assume any liability arising out of the application or use of any product or circuit, and specifically disclaims any and all liability, including without limitation special, consequential or incidental damages. "Typical" parameters which may be provided in SCILLC data sheets and/or specifications can and do vary in different applications and actual performance may vary over time. All operating parameters, including "Typicals" must be validated for each customer application by customer's technical experts. SCILLC does not convey any license under its patent rights nor the rights of others. SCILLC products are not designed, intended, or authorized for use as components in systems intended for surgical implant into the body, or other applications intended to support or sustain life, or for any other application in which the failure of the SCILLC product could create a situation where personal injury or death may occur. Should Buyer purchase or use SCILLC products for any such unintended or unauthorized application, Buyer shall indemnify and hold SCILLC and its officers, employees, subsidiaries, affiliates, and distributors harmless against all claims, costs, damages, and expenses, and reasonable attorney fees arising out of, directly or indirectly, any claim of personal injury or death associated with such unintended or unauthorized use, even if such claim alleges that SCILLC was negligent regarding the design or manufacture of the part. SCILLC is an Equal Opportunity/Affirmative Action Employer. This literature is subject to all applicable copyright laws and is not for resale in any manner.

**PUBLICATION ORDERING INFORMATION**

**LITERATURE FULFILLMENT:**

**Literature Distribution Center for ON Semiconductor**  
**P.O. Box 5163, Denver, Colorado 80217 USA**  
 Phone: **303-675-2175 or 800-344-3860 Toll Free USA/Canada**  
 Fax: **303-675-2176 or 800-344-3867 Toll Free USA/Canada**  
 Email: **orderlit@onsemi.com**

N. American Technical Support: **800-282-9855**  
**Toll Free USA/Canada**  
 Europe, Middle East and Africa Technical Support:  
**Phone: 421 33 790 2910**  
 Japan Customer Focus Center  
**Phone: 81-3-5773-3850**

**ON Semiconductor Website: [www.onsemi.com](http://www.onsemi.com)**  
**Order Literature: <http://www.onsemi.com/orderlit>**  
**For additional information, please contact your local Sales Representative**