

# Half Controlled Single Phase Rectifier Bridge with Freewheeling Diode

**$I_{dAVM} = 40 \text{ A}$**   
 **$V_{RRM} = 800-1600 \text{ V}$**

$V_{RSM}$ $V_{DSM}$ V	$V_{RRM}$ $V_{DRM}$ V	Type
900	800	VHF 36-08io5
1300	1200	VHF 36-12io5
1500	1400	VHF 36-14io5
1700	1600	VHF 36-16io5

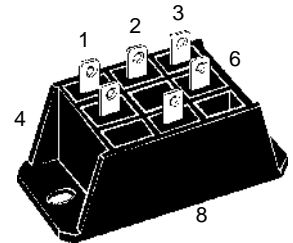
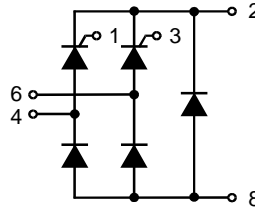

Symbol	Test Conditions	Maximum Ratings	
$I_{dAV}$	$T_K = 85^\circ\text{C}$ , module	36 A	
$I_{dAVM}$ ①	module	40 A	
$I_{FRMS}$ , $I_{TRMS}$	per leg	28 A	
$I_{FSM}$ , $I_{TSM}$	$T_{VJ} = 45^\circ\text{C}$ ; $V_R = 0 \text{ V}$	$t = 10 \text{ ms}$ (50 Hz), sine $t = 8.3 \text{ ms}$ (60 Hz), sine	320 A 350 A
	$T_{VJ} = T_{VJM}$ $V_R = 0 \text{ V}$	$t = 10 \text{ ms}$ (50 Hz), sine $t = 8.3 \text{ ms}$ (60 Hz), sine	280 A 310 A
$I^2t$	$T_{VJ} = 45^\circ\text{C}$ $V_R = 0 \text{ V}$	$t = 10 \text{ ms}$ (50 Hz), sine $t = 8.3 \text{ ms}$ (60 Hz), sine	500 A <sup>2</sup> s 520 A <sup>2</sup> s
	$T_{VJ} = T_{VJM}$ $V_R = 0 \text{ V}$	$t = 10 \text{ ms}$ (50 Hz), sine $t = 8.3 \text{ ms}$ (60 Hz), sine	390 A <sup>2</sup> s 400 A <sup>2</sup> s
$(di/dt)_{cr}$	$T_{VJ} = 125^\circ\text{C}$ $f = 50 \text{ Hz}$ , $t_p = 200 \mu\text{s}$ $V_D = 2/3 V_{DRM}$ $I_G = 0.3 \text{ A}$ , $di_G/dt = 0.3 \text{ A}/\mu\text{s}$	repetitive, $I_T = 50 \text{ A}$	150 A/ $\mu\text{s}$
		non repetitive, $I_T = 1/2 \cdot I_{dAV}$	500 A/ $\mu\text{s}$
$(dv/dt)_{cr}$	$T_{VJ} = T_{VJM}$ ; $V_{DR} = 2/3 V_{DRM}$ $R_{GK} = \infty$ ; method 1 (linear voltage rise)		1000 V/ $\mu\text{s}$
$V_{RGM}$			10 V
$P_{GM}$	$T_{VJ} = T_{VJM}$ $I_T = I_{TAVM}$	$t_p = 30 \mu\text{s}$	$\leq 10 \text{ W}$
		$t_p = 500 \mu\text{s}$	$\leq 5 \text{ W}$
		$t_p = 10 \text{ ms}$	$\leq 1 \text{ W}$
$P_{GAVM}$			0.5 W
$T_{VJ}$			-40...+125 °C
$T_{VJM}$			125 °C
$T_{stg}$			-40...+125 °C
$V_{ISOL}$	50/60 Hz, RMS $I_{ISOL} \leq 1 \text{ mA}$	$t = 1 \text{ min}$	3000 V~
		$t = 1 \text{ s}$	3600 V~
$M_d$	Mounting torque	(M5)	2-2.5 Nm
		(10-32 UNF)	18-22 lb.in.
Weight			50 g

### Features

- Package with DCB ceramic base plate
- Isolation voltage 3600 V~
- Planar passivated chips
- ¼" fast-on terminals
- UL registered E 72873

### Applications

- Supply for DC power equipment
- DC motor control

### Advantages

- Easy to mount with two screws
- Space and weight savings
- Improved temperature and power cycling

### Dimensions in mm (1 mm = 0.0394")

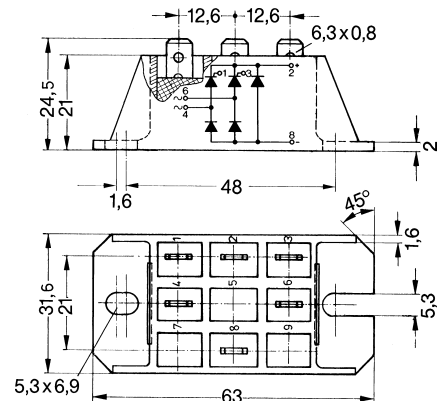

Data according to IEC 60747 and refer to a single thyristor/diode unless otherwise stated.

① for resistive load

IXYS reserves the right to change limits, test conditions and dimensions.

Symbol	Test Conditions	Characteristic Values
$I_R, I_D$	$V_R = V_{RRM}; V_D = V_{DRM}$ $T_{VJ} = T_{VJM}$ $T_{VJ} = 25^\circ\text{C}$	$\leq 5$ mA $\leq 0.3$ mA
$V_T, V_F$	$I_T, I_F = 45$ A; $T_{VJ} = 25^\circ\text{C}$	$\leq 1.45$ V
$V_{T0}$	For power-loss calculations only ( $T_{VJ} = 125^\circ\text{C}$ )	0.85 V
$r_T$		13 m $\Omega$
$V_{GT}$	$V_D = 6$ V; $T_{VJ} = 25^\circ\text{C}$ $T_{VJ} = -40^\circ\text{C}$	$\leq 1.0$ V $\leq 1.2$ V
$I_{GT}$	$V_D = 6$ V; $T_{VJ} = 25^\circ\text{C}$ $T_{VJ} = -40^\circ\text{C}$ $T_{VJ} = 125^\circ\text{C}$	$\leq 65$ mA $\leq 80$ mA $\leq 50$ mA
$V_{GD}$	$T_{VJ} = T_{VJM}; V_D = 2/3 V_{DRM}$	$\leq 0.2$ V
$I_{GD}$	$T_{VJ} = T_{VJM}; V_D = 2/3 V_{DRM}$	$\leq 5$ mA
$I_L$	$I_G = 0.3$ A; $t_g = 30$ $\mu\text{s}$ ; $di_G/dt = 0.3$ A/ $\mu\text{s}$ ; $T_{VJ} = 25^\circ\text{C}$ $T_{VJ} = -40^\circ\text{C}$ $T_{VJ} = 125^\circ\text{C}$	$\leq 150$ mA $\leq 200$ mA $\leq 100$ mA
$I_H$	$T_{VJ} = 25^\circ\text{C}; V_D = 6$ V; $R_{GK} = \infty$	$\leq 100$ mA
$t_{gd}$	$T_{VJ} = 25^\circ\text{C}; V_D = 1/2 V_{DRM}$ $I_G = 0.3$ A; $di_G/dt = 0.3$ A/ $\mu\text{s}$	$\leq 2$ $\mu\text{s}$
$t_q$	$T_{VJ} = 125^\circ\text{C}; I_T = 15$ A, $t_p = 300$ $\mu\text{s}$ , $V_R = 100$ V	typ. 150 $\mu\text{s}$
$Q_r$	$di/dt = -10$ A/ $\mu\text{s}$ , $dv/dt = 20$ V/ $\mu\text{s}$ , $V_D = 2/3 V_{DRM}$	75 $\mu\text{C}$
$R_{thJC}$	per thyristor (diode); DC current	1.15 K/W
	per module	0.29 K/W
$R_{thJK}$	per thyristor (diode); DC current	1.55 K/W
	per module	0.39 K/W
$d_s$	Creeping distance on surface	12.6 mm
$d_A$	Creepage distance in air	6.3 mm
$a$	Max. allowable acceleration	50 m/s <sup>2</sup>

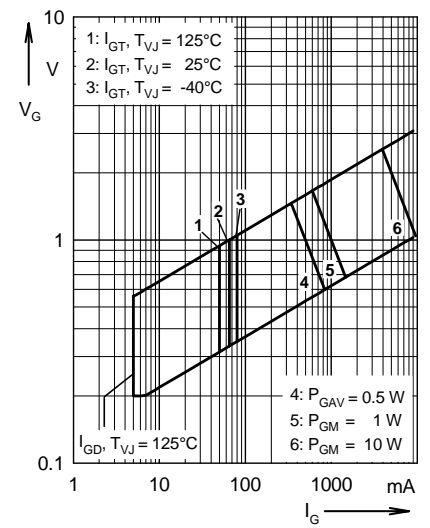

Fig. 1 Gate trigger range

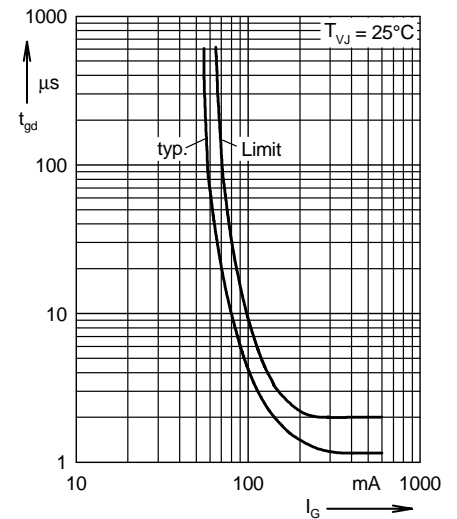

Fig. 2 Gate controlled delay time  $t_{gd}$

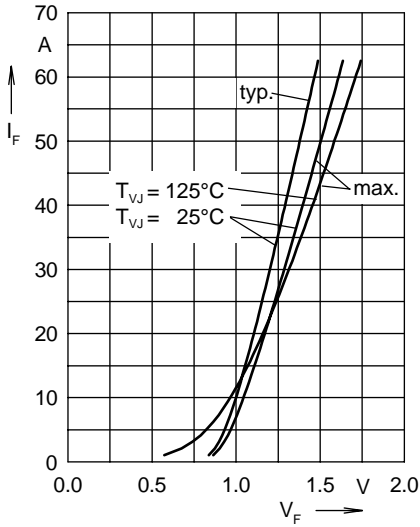

Fig. 3 Forward current versus voltage drop per diode

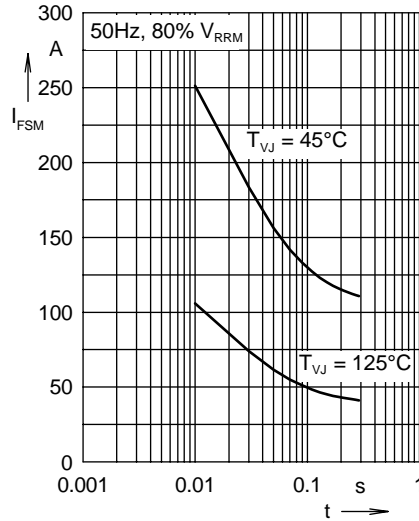

Fig. 4 Surge overload current

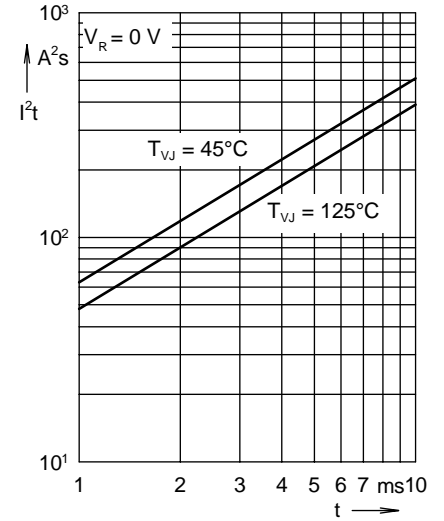

Fig. 5  $I^2t$  versus time per diode

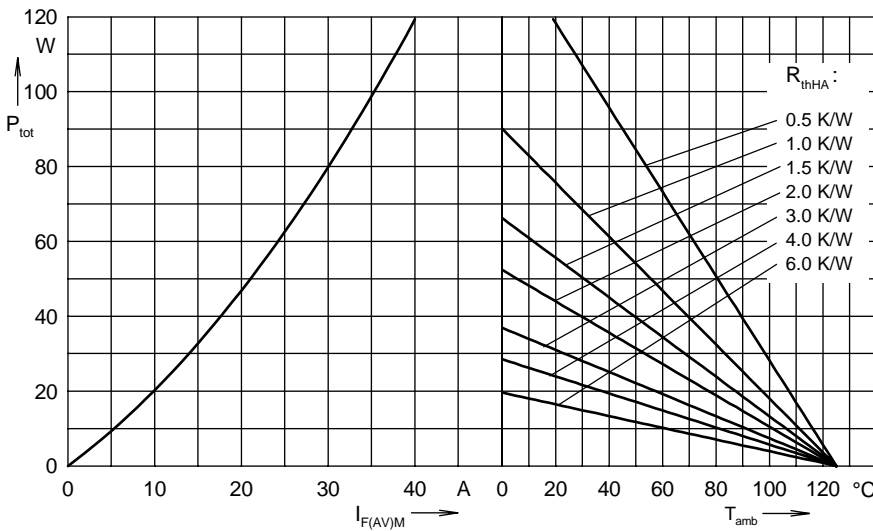

Fig. 6 Power dissipation versus direct output current and ambient temperature

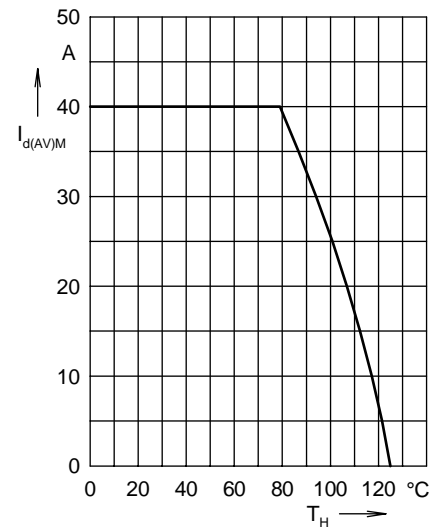

Fig. 7 Max. forward current versus heatsink temperature

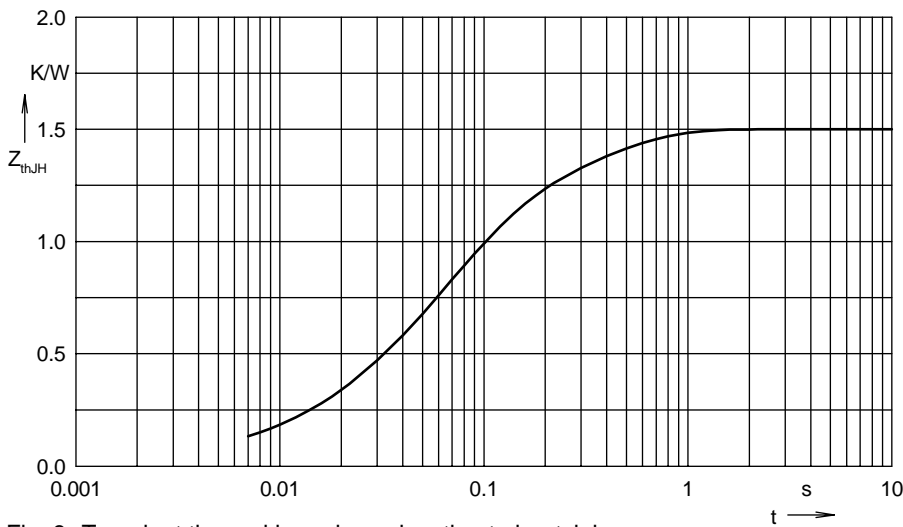

Fig. 8 Transient thermal impedance junction to heatsink

Constants for  $Z_{thJH}$  calculation:

i	$R_{thi}$ (K/W)	$t_i$ (s)
1	0.005	0.008
2	0.2	0.05
3	0.875	0.06
4	0.47	0.25