

Small Toroid RF Chokes

Miniature Two Lead Thru-hole Packages
Excellent Electrical Performance - High Q

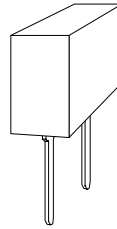

Applications Include
 Satellite Communications
 Microwave Equipment
 Broadcast TV
 Cable TV Systems
 Test Equipment
 AM/FM Radio
 Receivers/Transmitters
 Scanners

Electrical Specifications at 25° C

PARAMETER	MIN.	TYP.	MAX.	UNITS
Inductance ¹	312	390	468	μH
Q ²		80		
DCR Pins 1-2		3.2		Ω
Self Resonance Frequency		3.8		MHz

Flammability: Materials used in the production of these units meet requirements of UL94-VO and IEC 695-2-2 needle flame test.

1. Tested @ 100 kHz - 100 mV

2. @ 1MHz

Dimensions in inches (mm)

Code	L	W	H
MT3	0.385 (9.78)	0.195 (4.95)	0.395 (10.03)

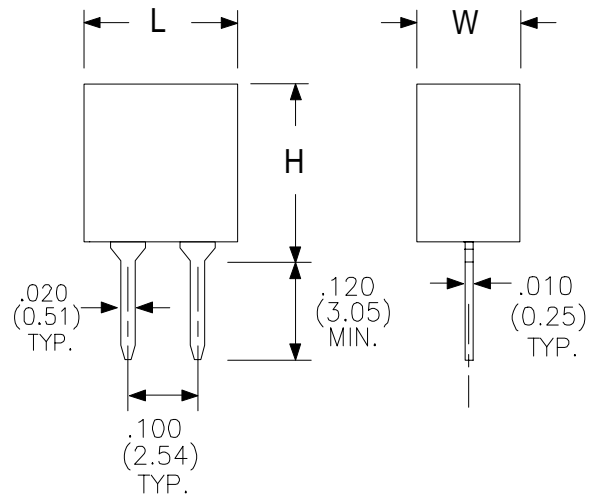

Schematic Diagram

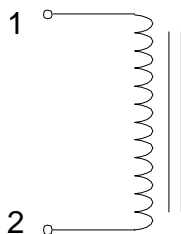

RHOMBUS P/N: **L-11782F**

CUST P/N:

NAME:

DATE: 02/02/00

SHEET: 1 OF 1