

## TO-92 Plastic-Encapsulate Transistors

TRANSISTOR (NPN)

### FEATURES

- Complementary to S9012
- Excellent  $h_{FE}$  linearity

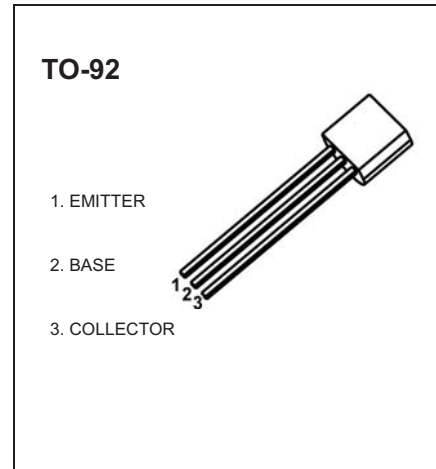

### MARKING

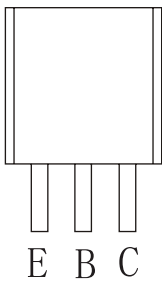

### Equivalent Circuit

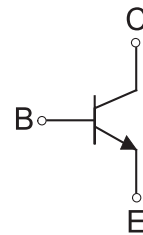

### ORDERING INFORMATION

Part Number	Package	Packing Method	Pack Quantity
S9013	TO-92	Bulk	1000pcs/Bag
S9013-TA	TO-92	Tape	2000pcs/Box

### MAXIMUM RATINGS ( $T_a=25^{\circ}\text{C}$ unless otherwise noted)

Symbol	Parameter	Value	Unit
$V_{CBO}$	Collector-Base Voltage	40	V
$V_{CEO}$	Collector-Emitter Voltage	25	V
$V_{EBO}$	Emitter-Base Voltage	5	V
$I_C$	Collector Current -Continuous	0.5	A
$P_D$	Collector Power Dissipation	625	mW
$R_{\theta JA}$	Thermal Resistance from Junction to Ambient	200	$^{\circ}\text{C} / \text{W}$
$T_j$	Junction Temperature	150	$^{\circ}\text{C}$
$T_{stg}$	Storage Temperature	-55 ~ +150	$^{\circ}\text{C}$

## ELECTRICAL CHARACTERISTICS

$T_a=25\text{ }^\circ\text{C}$  unless otherwise specified

Parameter	Symbol	Test conditions	Min	Typ	Max	Unit
Collector-base breakdown voltage	$V_{(BR)CBO}$	$I_C=100\mu\text{A}$ , $I_E=0$	40			V
Collector-emitter breakdown voltage	$V_{(BR)CEO}$	$I_C=1\text{mA}$ , $I_B=0$	25			V
Emitter-base breakdown voltage	$V_{(BR)EBO}$	$I_E=100\mu\text{A}$ , $I_C=0$	5			V
Collector cut-off current	$I_{CBO}$	$V_{CB}=40\text{V}$ , $I_E=0$			0.1	$\mu\text{A}$
Collector cut-off current	$I_{CEO}$	$V_{CE}=20\text{V}$ , $I_E=0$			0.1	$\mu\text{A}$
Emitter cut-off current	$I_{EBO}$	$V_{EB}=5\text{V}$ , $I_C=0$			0.1	$\mu\text{A}$
DC current gain	$h_{FE(1)}$	$V_{CE}=1\text{V}$ , $I_C=50\text{mA}$	64		400	
	$h_{FE(2)}$	$V_{CE}=1\text{V}$ , $I_C=500\text{mA}$	40			
Collector-emitter saturation voltage	$V_{CE(sat)}$	$I_C=500\text{mA}$ , $I_B=50\text{mA}$			0.6	V
Base-emitter voltage	$V_{BE(sat)}$	$I_C=500\text{mA}$ , $I_B=50\text{mA}$			1.2	V
Transition frequency	$f_T$	$V_{CE}=6\text{V}$ , $I_C=20\text{mA}$ , $f=30\text{MHz}$	150			MHz

### CLASSIFICATION OF $h_{FE(1)}$

Rank	D	E	F	G	H	I	J
Range	64-91	78-112	96-135	112-166	144-202	190-300	300-400

## Typical Characteristics

Static Characteristic

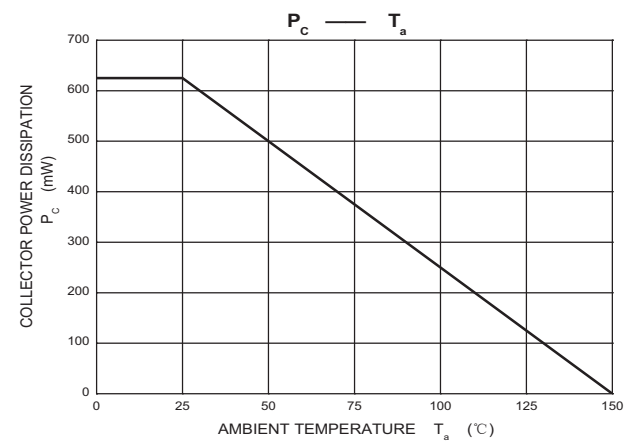
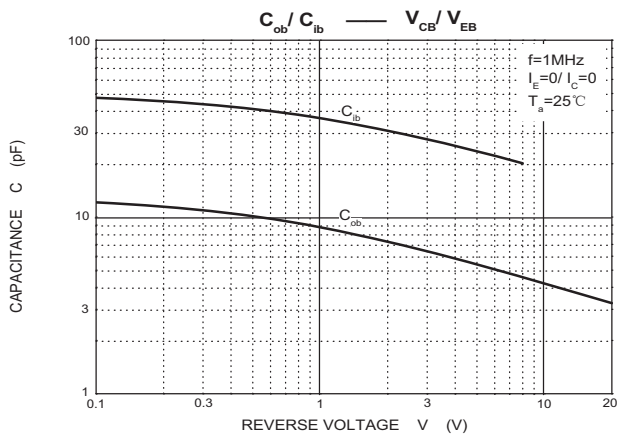
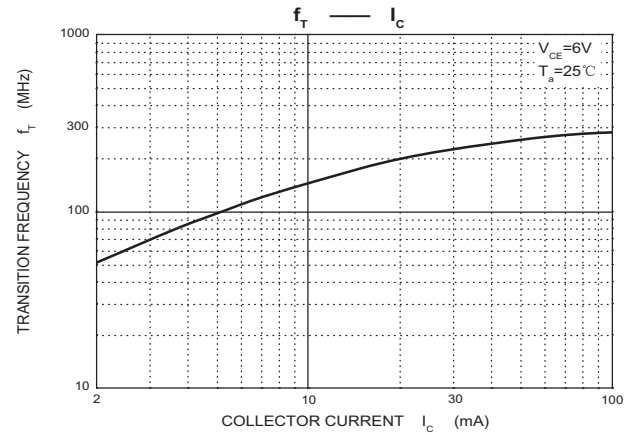
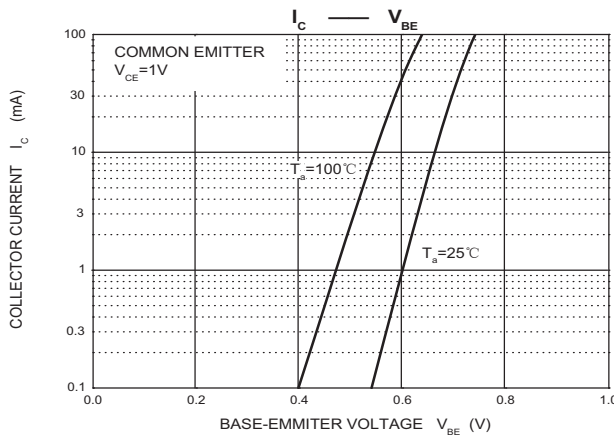
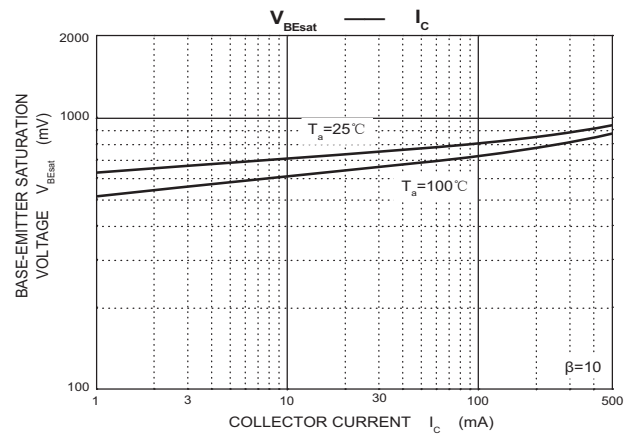
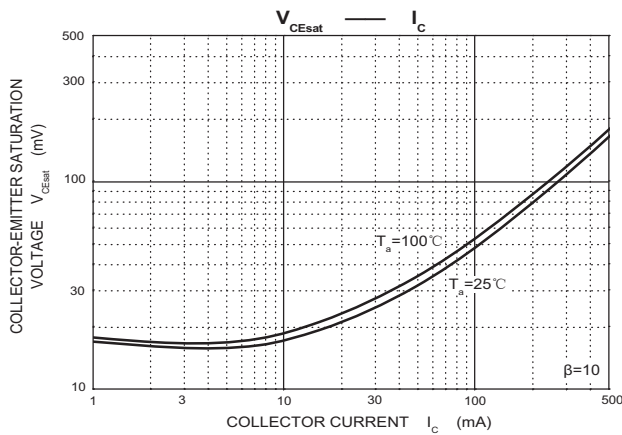
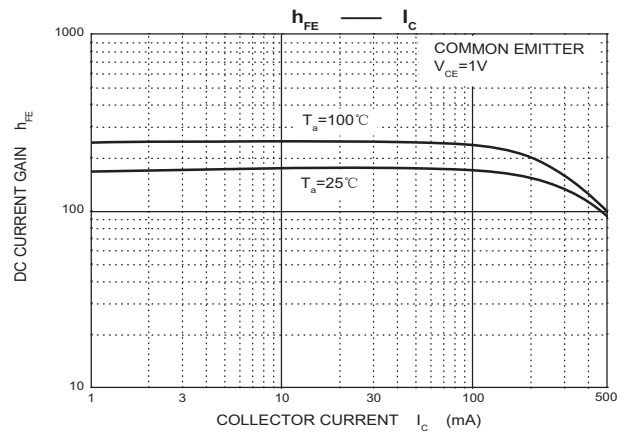
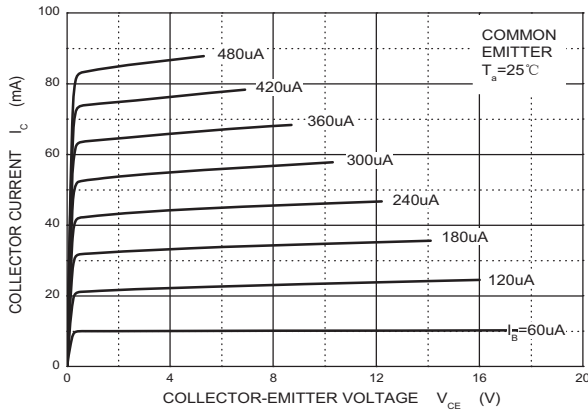

### TO-92 Package Outline Dimensions

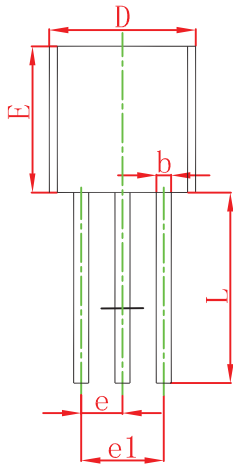
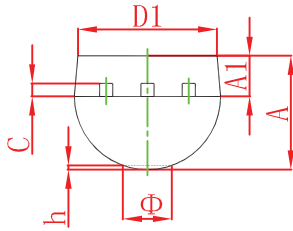

Symbol	Dimensions In Millimeters		Dimensions In Inches	
	Min	Max	Min	Max
A	3.300	3.700	0.130	0.146
A1	1.100	1.400	0.043	0.055
b	0.380	0.550	0.015	0.022
c	0.360	0.510	0.014	0.020
D	4.300	4.700	0.169	0.185
D1	3.430		0.135	
E	4.300	4.700	0.169	0.185
e	1.270 TYP		0.050 TYP	
e1	2.440	2.640	0.096	0.104
L	14.100	14.500	0.555	0.571
Φ		1.600		0.063
h	0.000	0.380	0.000	0.015

### TO-92 Suggested Pad Layout

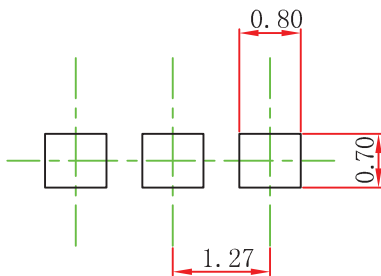

**Note:**

1. Controlling dimension: in millimeters.
2. General tolerance:  $\pm 0.05\text{mm}$ .
3. The pad layout is for reference purposes only.