

1625 nm DFB LASER DIODE MODULES
UNCOOLED MQW DFB LD WITH RECEPTACLE

DL-5500-1625 Series

FEATURES

- ✧ 1625 nm Uncooled Laser Diode with MQW Structure
- ✧ High Reliability, Long Operation Life
- ✧ Single Frequency Operation with High SMSR
- ✧ 0 to 70°C operation without active cooling
- ✧ Build-in InGaAs monitor
- ✧ Build-in single stage isolator

APPLICATION

Trunk Line, FitL

DESCRIPTION

DL-5500-1625 series are designed for coupling a single mode optical fiber with 1625 nm MQW DFB uncooled laser diode. DL-5500-1625 series are the best kits as light sources for telecom and datacom applications.

ELECTRICAL AND OPTICAL CHARACTERISTICS (T_c=25 °C)						
Symbol	Parameter	Test Conditions	Min.	Typ.	Max.	Unit
I _{th}	Threshold Current	CW		10	15	mA
V _{OP}	Operating Voltage	CW, I _F =I _{th} +25mA		1.2	1.5	V
P _f	Optical Output Power Part No:DL-552XX-1625 DL-553XX-1625	CW, I _F =I _{th} +25mA	1.0 2.0		2.0 3.0	mW
λ _c	Center Wavelength	CW, I _{th} +25mA	1620	1625	1630	nm
SMSR	Side Mode Suppression Ratio	CW, I _{th} +25mA	30	35		dB
t _r , t _f	Rise And Fall Times Part No:DL-55XX-1625 DL-55XXS-1625	I _F =I _{th} , I _{th} +25mA, 20~80%			226 150	ps
ΔP _f /P _f	Tracking Error	APC, 0~+70 °C	-1.5		1.5	dB
I _m	PD Monitor Current	CW, I _{th} +25mA, V _{RD} =1V	100			μA
I _D	PD Dark Current	V _{RD} =5V			0.1	μA
C _t	PD Capacitance	V _{RD} =5V, f=1MHz		10	15	pF

ABSOLUTE MAXIMUM RATINGS (T_c=25 °C)			
Symbol	Parameter	Ratings	Unit
P _o	Optical Output Power (552XX/553XX)	1.5/3	mW
V _{RL}	LD Reverse Voltage	2	V
V _{RD}	PD Reverse Voltage	10	V
I _{FD}	PD Forward Current	1.0	mA
T _{opr}	Operating Temperature	0 to 70	°C
T _{stg}	Storage Temperature	-40~+85	°C

MECHANICAL DIMENSION (mm) and PIN ASSIGNMENT

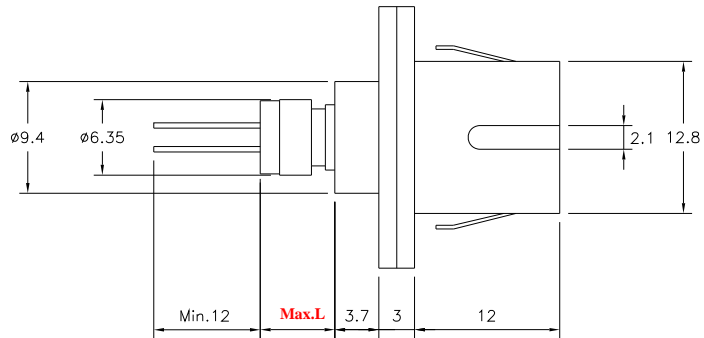
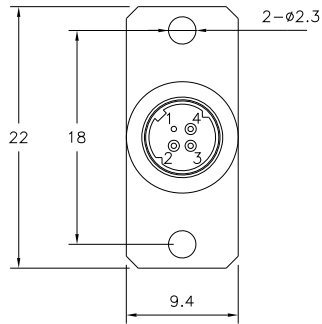
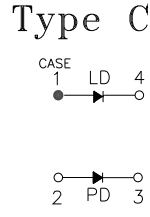
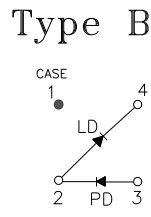
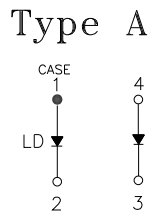

**SC RECEPTACLE
(DL-55XXX-1625-SS)**

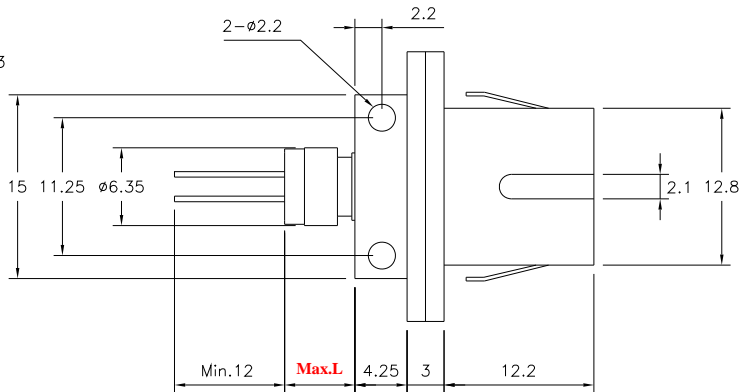
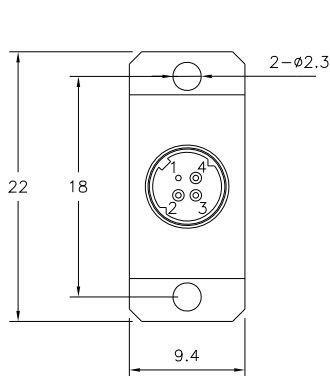

**SC RECEPTACLE (BOARD MOUNT)
(DL-55XXX-1625-SBS)**

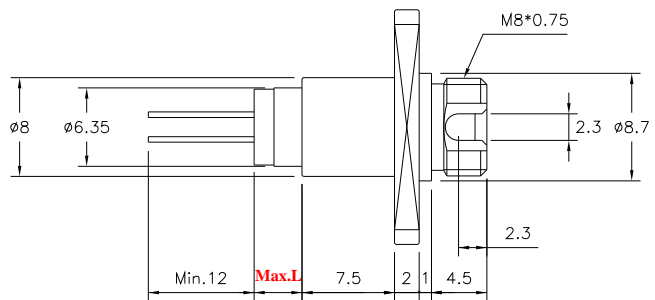
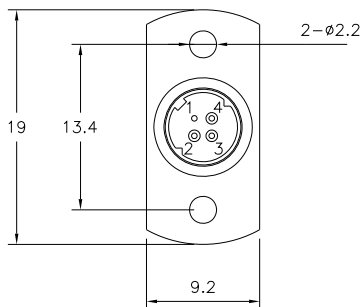

**FC RECEPTACLE
(DL-55XXX-1625-FS)**

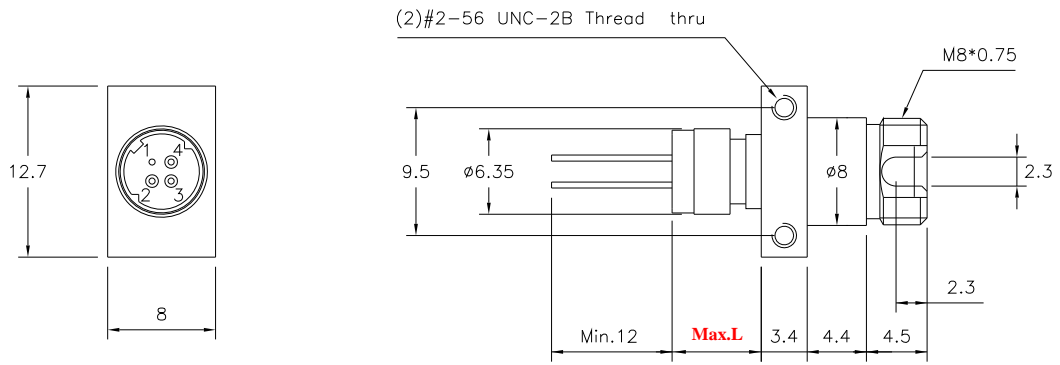

FC RECEPTACLE (BOARD MOUNT)
(DL-55XXX-1625-FBS)

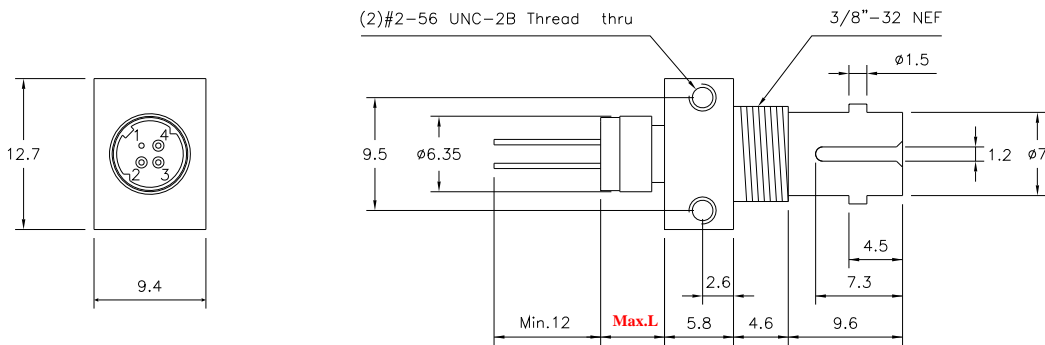

ST RECEPTACLE
(DL-55XXX-1625-TS)

P/N	Max. L Dimension				
	S	SB	F	FB	T
552XX-1625-XS	8.6	8.0	6.2	8.9	7.7
553XX-1625-XS	10.6	10.0	8.2	10.9	9.7

Note: Specifications subject to change without notice.

ORDER INFORMATION

Part No.: D L - 5 5 - 1 6 2 5 - S

Code	Pout (mW)
2	1
3	2

Code	Pin Assignment
0	Type A
5	Type B
8	Type C

Code	Connector Type
F	FC/PC
FB	FC/PC (Board Mount)
T	ST/PC
S	SC/PC
SB	SC/PC (Board Mount)

Code	Isolator
S	Single-Stage

Code	Speed
Blank	1.25 Gbps
S	2.5 Gbps

Revision History

Version	Subject	Release Date
1.0	Initial datasheet	2003/5/1
2.0	1. Combine 1.25G and 2.5G characteristics in one data sheet 2. Revise FC RECEPTACLE (BOARD MOUNT) thread thru dim.: M2 => UNC-2B 3. Revise drawing	2007/12/1
3.0	Revise mechanical dimension and order information	2009/4/10