

POWER RELAY

1 POLE - 10A Medium Load Control

JV-KS Series

■ FEATURES

- UL, CSA, VDE, CQC recognized
 - UL class B (130°C) wire class
 - Low profile and space saving
 - Height: 12.5 mm
 - Mounting space: 175 mm²
 - High sensitivity in small package
 - Operating power: 0.145 W
 - Nominal power: 0.25W
 - High insulation with reinforced insulation system (between coil and contacts)
 - Insulation distance: 8 mm
 - Dielectric strength: 5,000 VAC
 - Surge strength: 10,000 V
 - Plastic materials
 - UL94 flame class V-0
 - UL CTI level class 2
 - Plastic sealed type, RTIII
 - RoHS compliant.
- Please see page 6 for more information



■ PARTNUMBER INFORMATION

[Example] $\frac{JV}{(a)}$ - $\frac{12}{(*) (b)}$ $\frac{S}{(c)}$ - $\frac{K}{(d)}$ $\frac{S}{(e)}$

(a)	Relay type	JV	: JV-Series
(b)	Coil rated voltage	12	: 3.....48 VDC Coil rating table at page 3
(c)	Coil type	S	: High sensitive type (250mW)
(d)	Enclosure	K	: Plastic sealed type, RTIII
(f)	Construction	S	: High power type 10A

Note: Actual marking omits the hyphen (-) of (*)

■ SPECIFICATION

Item			High power type
			JV- () - KS
Contact Data	Configuration		1 form A (SPST-NO)
	Construction		Single
	Material		Silver alloy
	Resistance (Initial)		Max. 70 mΩ at 6 VDC, 1 A
	Contact rating		10A, 250VAC / 24VDC (resistive)
	Max. carrying current		10A
	Max. inrush current		65A 250VAC
	Max. switching voltage		250VAC / 150 VDC
	Max. switching power		2,500VA / 240W
	Max. switching current		10A
	Min. switching load *		100 mA, 5 VDC
Life	Mechanical		Min. 5 x 10 ⁶ operations
	Electrical		Min. 50 x 10 ³ operations (resistive)
			Min. 25 x 10 ³ operations (lamp, UL TV-4)
Coil Data	Rated power (at 20 °C)		250mW
	Operating temperature range		-40 °C to +85°C (no frost)
Timing Data	Operate (at nominal voltage)		Max. 8 ms (without bounce)
	Release (at nominal voltage)		Max. 4 ms (no diode)
Insulation	Resistance (initial)		Min 1,000MΩ at 500VDC
	Dielectric strength	Open contacts	750VAC, 1 min.
		Contacts to coil	5,000VAC, 1 min.
	Surge strength	Coil to contacts	10,000V / 1.2 x 50μs standard wave
Other	Vibration resistance	Misoperation	10 to 55 to 10 Hz single amplitude 0.825 mm
		Endurance	10 to 55 to 10Hz single amplitude 2.5 mm
	Shock	Misoperation	Min. 100m/s ² (11 ± 1ms)
		Endurance	Min. 1,000m/s ² (6 ± 1ms)
	Weight	Approximately 4.3 g	
	Sealing	Plastic sealed RTIII	

* Minimum switching loads mentioned above are reference values. Please perform the confirmation test with actual load before production since reference values may vary according to switching frequencies, environmental conditions and expected reliability levels.

■ COIL RATING

10A High power type (250 mW)

Coil Code	Rated Coil Voltage (VDC)	Coil Resistance +/- 10% (Ohm)	Must Operate Voltage (VDC) *	Must Release Voltage (VDC) *	Rated Power (mW)
3	3	36	2.1	0.3	250 mW
5	5	100	3.5	0.5	
6	6	144	4.2	0.6	
9	9	324	6.3	0.9	
12	12	576	8.4	1.2	
18	18	1,296	12.6	1.8	
24	24	2,304	14.9	2.4	

Note: All values in the tables are valid for 20°C and zero contact current.

* Specified operate values are valid for pulse wave voltage.

■ Please use at rated coil voltage. Please refer to characteristic data and set up adequate voltage in case of use at over voltage.

■ SAFETY STANDARDS

Type	Compliance	Contact rating
UL	UL 508, UL 873	Flammability: UL 94-V0 (plastics)
	E56140	10A, 250 VAC / 24 VDC (resistive), 50K TV-4 120VAC (UL)
CSA	C22.2 No. 14 LR 35579	
VDE	IEC/EN61810-1 EN60335-1 clause 15.3; 16.3; 29.1; 29.2; 29.3 EN60730-1 clause 12.2; 13.2; 20.1; 20.2; 20.3	10A, 250VAC ($\cos\phi=1$), 25K 10A, 30VDC (0ms), 100K
CQC	GB/T21711.1 GB15092-2010 17002164384	10A 250VAC 13A 250VAC

■ CHARACTERISTIC DATA

(Characteristic data is not guaranteed value but measured values of samples from production line.)

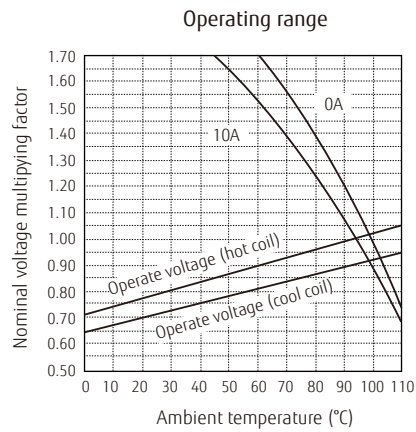
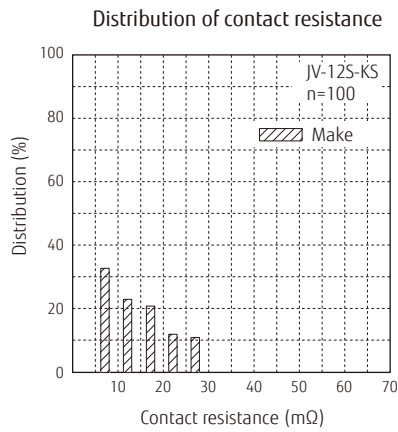
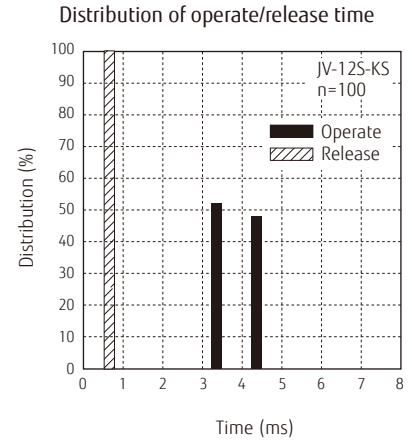
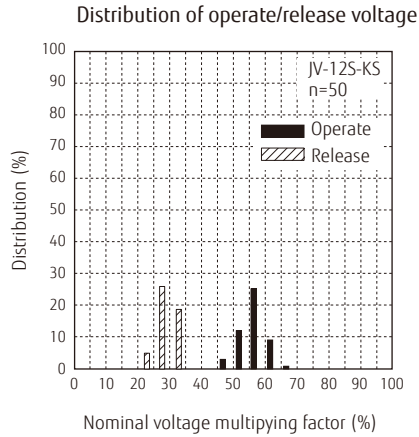
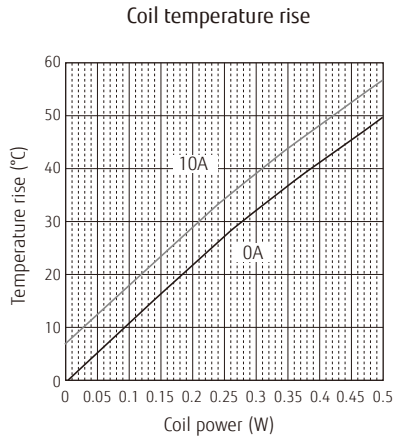

■ DIMENSIONS

● Dimensions

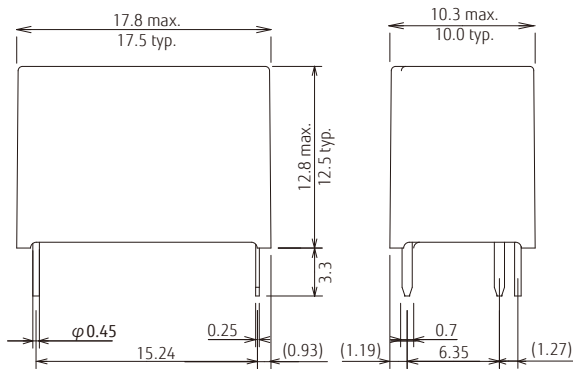

● Schematics (BOTTOM VIEW)

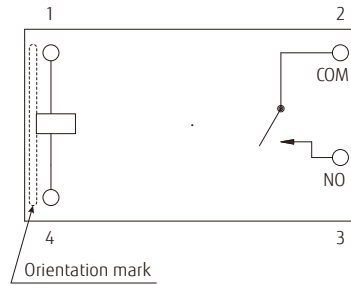

● PC board mounting hole layout (BOTTOM VIEW)

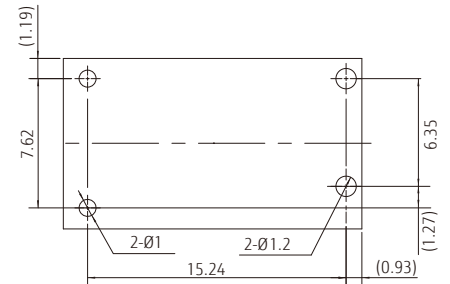

- * Dimensions of the terminals do not include thickness of pre-solder.
- * Dimensions do not include tolerances.
- * Tolerance of PC board mounting hole layout : ± 0.1 unless otherwise specified.

Unit: mm
(): Reference

Cautions

- All values mentioned in this datasheet are provided under ideal conditions. Please perform the confirmation test before actual use.
- Reflow soldering is prohibited.
- Do not use relays in the atmosphere with sulfide gas, chloride gas or nitric oxide. Contact resistance may increase.
- Do not use silicon or silicon-containing product or materials near relays. It may cause contact failure.

RoHS Compliance and Lead Free Information

1. General Information

- All signal and power relays produced by Fujitsu Components are compliant with RoHS directive 2002/95EC including amendments.
- Cadmium as used in electrical contacts is exempted from the RoHS directives on October 21st, 2005. (Amendment to Directive 2002/95/EC)
- All of our signal and power relays are lead-free. Please refer to Lead-Free Status Info for older date codes at: <http://www.fujitsu.com/us/downloads/MICRO/fcai/relays/lead-free-letter.pdf>
- Lead free solder plating on relay terminals is Sn-3.0Ag-0.5Cu, unless otherwise specified. This material has been verified to be compatible with PbSn assembly process.

2. Recommended Lead Free Solder Profile

- **Recommended solder Sn-3.0Ag-0.5Cu.**

Flow Solder condition:

Pre-heating: maximum 120°C within 90 sec.
Soldering: dip within 5 sec. at 255°C±5°C solder bath
Relay must be cooled by air immediately after soldering

Solder by Soldering Iron:

Soldering Iron: 30-60W
Temperature: maximum 340-360°C
Duration: maximum 3 sec.

We highly recommend that you confirm your actual solder conditions

3. Moisture Sensitivity

- Moisture Sensitivity Level standard is not applicable to electromechanical relays, unless otherwise indicated.

4. Tin Whiskers

- Dipped SnAgCu solder is known as presenting a low risk to tin whisker development. No considerable length whisker was found by our in house test.

Fujitsu Components International Headquarter Offices

Japan FUJITSU COMPONENT LIMITED Shinagawa Seaside Park Tower 19F, 12-4, Higashi-shinagawa 4-chome, Shinagawa-ku, Tokyo, 140-0002, Japan Tel: (81-3) 3450-1682 Fax: (81-3) 3474-2385 Email: fcl-contact@cs.jp.fujitsu.com Web: www.fujitsu.com/jp/fcl/	Asia Pacific FUJITSU COMPONENTS ASIA, LTD. 102E Pasir Panjang Road #01-01 Citilink Warehouse Complex Singapore 118529 Tel: (65) 6375-8560 Fax: (65) 6273-3021 Email: fcal@sg.fujitsu.com Web: www.fujitsu.com/sg/products/devices/components	Korea FUJITSU COMPONENTS KOREA LIMITED Alpha Tower #403, 645 Sampyeong-dong, Bundang-gu, Seongnam-si, Gyeonggi-do, 13524 Korea Tel: (82) 31-708-7108 Fax: (82) 31-709-7108 Email: fcal@sg.fujitsu.com www.fujitsu.com/sg/products/devices/components/
North and South America FUJITSU COMPONENTS AMERICA, INC 2290 North First Street, Suite 212 San Jose, CA 95131, USA Tel: (1-408) 745-4900 Fax: (1-408) 745-4970 Email: components@us.fujitsu.com Web: us.fujitsu.com/components	China FUJITSU ELECTRONIC COMPONENTS (SHANGHAI) CO., LTD. Unit 4306, InterContinental Center 100 Yu Tong Road, Shanghai 200070, China Tel: (86-21) 3253 0998 Fax: (86-21) 3253 0997 Email: fcsh@cn.fujitsu.com Web: www.fujitsu.com/cn/products/devices/components/	
Europe FUJITSU COMPONENTS EUROPE B.V. Diamantlaan 25 2132 WV Hoofddorp Netherlands Tel: (31-23) 5560910 Fax: (31-23) 5560950 Email: info@fceu.fujitsu.com Web: www.fujitsu.com/uk/components	Hong Kong FUJITSU COMPONENTS HONG KONG CO., LTD Unit 506, Inter-Continental Plaza No.94 Granville Road, Tsim Sha Tsui, Kowloon, Hong Kong Tel: (852) 2881-8495 Tex: (852) 2894-9512 Email: fcal@sg.fujitsu.com Web: www.fujitsu.com/sg/products/devices/components/	

© 2019 Fujitsu Components Europe B.V. All rights reserved. All trademarks or registered trademarks are the property of their respective owners.

The contents, data and information in this datasheet are provided by Fujitsu Component Ltd. as a service only to its user and only for general information purposes. The use of the contents, data and information provided in this datasheet is at the users' own risk.

Fujitsu has assembled this datasheet with care and will endeavor to keep the contents, data and information correct, accurate, comprehensive, complete and up to date.

Fujitsu Components Europe B.V. and affiliated companies do however not accept any responsibility or liability on their behalf, nor on behalf of its employees, for any loss or damage, direct, indirect or consequential, with respect to this datasheet, its contents, data, and information and related graphics and the correctness, reliability, accuracy, comprehensiveness, usefulness, availability and completeness thereof.

Nor do Fujitsu Components Europe B.V. and affiliated companies accept on their behalf, nor on behalf of its employees, any responsibility or liability with respect to these datasheets, its contents, data, information and related graphics and the correctness, reliability, accuracy, comprehensiveness, usefulness, availability and completeness thereof. Rev. July 5th, 2019