

REV.	ECN Number	Description	Drawn
1	CS18040027	RELEASE	XPG_2018.04.18

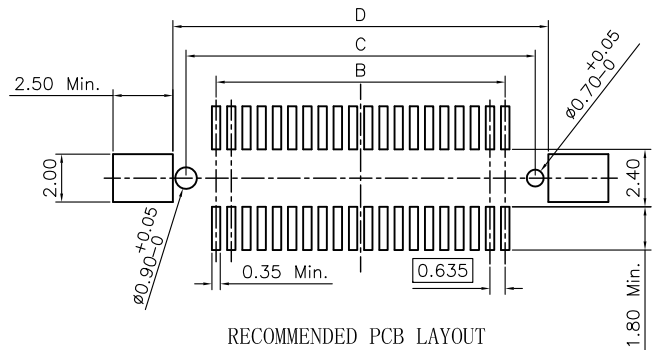

RECOMMENDED PCB LAYOUT
TOLERANCE ± 0.05

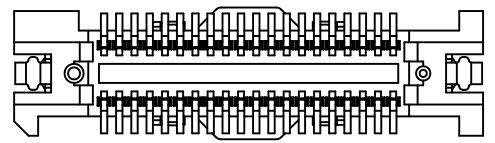
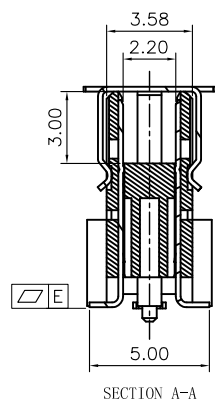
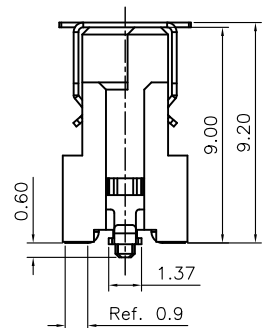
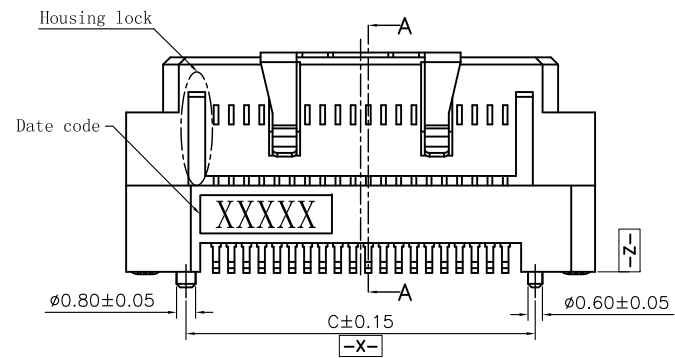
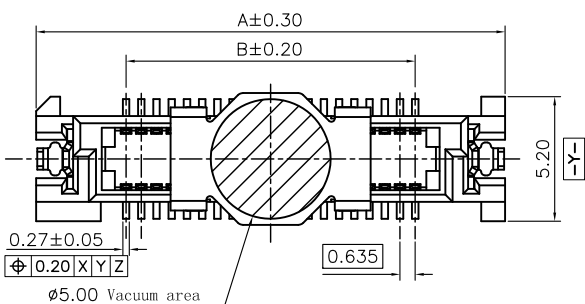
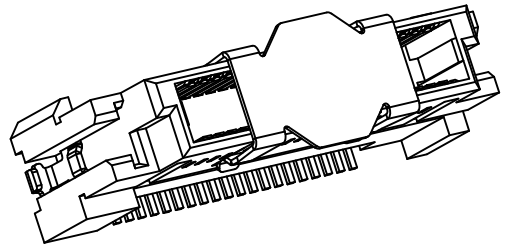

- NOTES: (UNLESS OTHERWISE SPECIFIED)
 1. DIMENSION SHALL BE INTERPRETED PER ANSI Y14.5M-1994.
 2. MATERIAL:
 HOUSING MATERIAL: HIGH TEMPERATURE PLASTICS.
 CONTACT & CLIP MATERIAL: COPPER ALLOY.
 VACUUM COVER MATERIAL: STAINLESS STEEL.
 3. ELECTRICAL SPECIFICATION:
 CONTACT RESISTANCE: 50m ohms Max.
 INSULATION RESISTANCE: 1000M ohms Min(250V).
 CURRENT RATING: 0.5A.
 DIELECTRIC WITHSTANDING VOLTAGE: 250V AC rms./minute
 4. MECHANICAL SPECIFICATION:
 DURABILITY:50 CYCLES.
 INSERTION FORCE: 70gf Max. PER PIN.
 WITHDRAWAL FORCE: 12gf Min. PER PIN.
 5. PRODUCT NUMBER MATRIX:

B A 3 1-XX A T-1 X -X X X

BTB
Series code
0.635 Pitch
Plug
PIN No.
20~90:20~90PIN
A0:100PIN ; G0:160PIN
C0:120PIN ; I0:180PIN
E0:140PIN ; K0:200PIN
Height
A: H=9.00mm
Soldering Type
T:SMT
1:With Chamfer
Housing Color
Null:Nature
B:Black

Packing:
B:REEL+MPAD
Q:HOT SEALING REEL+MPAD
H:Halogen free
F:High temperature thermoplastic
Contact plating

Definition	Code
◎ Gold plated over all	
flash B	1u" R 3u" C
5u" D	10u" E 15u" F
20u" G	25u" H 30u" J
◎ Duplex plated	
flash K	1u" S 3u" L
5u" M	10u" N 15u" P
20u" Q	25u" T 30u" U
◎ All plated is lead free.	

CKT	DIM.A	DIM.B	DIM.C	DIM.D	DIM.E	HOUSING LOCK
20	13.22	5.715	8.22	9.32	0.10	YES
30	16.395	8.89	11.395	12.495		
40	19.57	12.065	14.57	15.67		
50	22.745	15.24	17.545	18.845		
60	25.92	18.415	20.92	22.02		
70	29.095	21.59	24.095	25.195	0.12	NO
80	32.27	24.765	27.27	28.37		
90	35.445	27.94	30.445	31.545		
100	38.62	31.115	33.62	34.72		
120	44.97	37.465	39.97	41.07		
140	51.32	43.815	46.32	47.42	0.12	NO
160	57.67	50.165	52.67	53.77		
200	70.37	62.865	65.37	66.47		

OLD AND PART NO. COMPARISON	
OLD	NEW
AB31-40NB-H-001	BA31-40AT-1-NHB
AB31-40NB-F-001-B	BA31-40AT-1B-NFB
AB31-60NB-H-001	BA31-60AT-1-NHB



TOLERANCE UNLESS OTHERWISE SPECIFIED			
X.X	±0.30	X.°	±3°
X.XX	±0.20	X.X°	±2°
X.XXX		X.XX°	±1°

SCALE	1:1
UNIT	mm
SIZE	A4

ORIGINAL DRAWN: Xu Peiguang
 CHECK: Xie Yong
 APPROVE: Ady Zhou

DATE 2018.04.18
 DATE 2018.04.18
 DATE 2018.04.18

DWG. NO. 600-0000-0364
 PARTS NO. (INTENDED USE) BA31-XXAT-1X-XXX

TITLE
 BA31
 CUSTOMER DRAWING

REV. 1
 SHEET 1/1