



5S8W4_2RP Series

5W - Dual/Single Output - Wide Input - Isolated & Regulated DC-DC Converter

DC-DC Converter

5 Watt

- ⊕ Ultra wide 4:1 input voltage range
- ⊕ Very high efficiency up to 85%
- ⊕ 5W single and dual outputs
- ⊕ I/O isolation 2KVDC and 4kVDC option
- ⊕ Operating temperature range: -40°C to +85°C
- ⊕ Continuous Short Circuit Protection (SCP)
- ⊕ Remote ON/OFF Control

The 5S8W4_2RP series are specially designed for applications where a wide range input voltage power supplies are isolated from the input power supply in a distributed power supply system on a circuit board.

These products apply to:

- 1) Where the voltage of the input power supply is wide range (voltage range $\leq 2:1$)
- 2) Where isolation is necessary between input and output (isolation voltage $\leq 2000\text{VDC}/4000\text{VDC}$)
- 3) Where the regulation of the output voltage and the output ripple noise are demanded



Common specifications	
Input filter:	Capacitor
Short circuit protection:	Continuous
Operating case temperature:	+110°C MAX
Operating temperature range:	-40°C~+85°C (with derating)
Storage temperature range:	-55°C ~+125°C
Storage humidity range:	< 95%
Lead temperature range:	300°C MAX, 1.5mm from case for 10 sec
No-load power consumption:	100mW TYP / 300mW MAX
Temperature coefficient:	-40°C to +85°C ambient 0.02 %/°C TYP
Temperature rise at full load:	30°C TYP
Operating Frequency:	300kHz MIN
Case material:	Non-conductive black plastic [UL94-V0]
Potting material:	Epoxy [UL94-V0]
MTBF (MIL-HDBK 217F):	+25°C: 2106x10 ³ hours +75°C: 235x10 ³ hours
Weight:	4.7g

Output specifications						
Item	Test condition	Min	Typ	Max	Units	
Output accuracy	Nominal Vin and full load	±2			%	
Line regulation	Vin=min to max, full load	±0.5			%	
Load regulation	20% to 100% full load	±0.5			%	
Output Ripple & Noise	20MHz Bandwidth	60			mVp-p	
Remote Power OFF (leave open if not used) (15 VDC max.)	Device ON				open or <0.8 VDC	
	Device OFF Device OFF (Stand by input current)				CTRL>1.5VDC 0.5mA max.	

Example:

5S8W4_2405S2RP

5 = 5Watt; S8 = SIP8; W4 = wide input (4:1); 9-36Vin; 5Vout;

S = Single Output; 2 = 2000VDC; R = Regulated Output

P = Short Circuit Protection

Isolation specifications

Item	Test condition	Min	Typ	Max	Units
Isolation voltage	Tested for 1 second	2000 and 4000			VDC
Isolation resistance	500VDC, input to output	15			GΩ
Isolation capacitance	100KHz		30		pF

Note:

1. All specifications measured at Ta = 25°C, humidity <75%, nominal input voltage and rated output load unless otherwise specified.
2. In this datasheet, all the test methods of indications are based on corporate standards.

5S8W4_2RP Series

5W - Dual/Single Output - Wide Input - Isolated & Regulated
DC-DC Converter

Part Number	Input Voltage [V]	Output Voltage [VDC]	Output Current [mA, max]	Efficiency [%, typ]	Max. Capacitive Load [μ F]
5S8W4_xx03SXR	9-36, 18-75	3.3	1200	78-79	1000
5S8W4_xx05SXR	9-36, 18-75	5	1000	82-83	1000
5S8W4_xx09SXR	9-36, 18-75	9	556	83-84	680
5S8W4_xx12SXR	9-36, 18-75	12	420	85	470
5S8W4_xx15SXR	9-36, 18-75	15	340	85	330
5S8W4_xx05DXR	9-36, 18-75	\pm 5	\pm 500	83	\pm 470
5S8W4_xx09DXR	9-36, 18-75	\pm 9	\pm 278	84	\pm 330
5S8W4_xx12DXR	9-36, 18-75	\pm 12	\pm 210	85	\pm 100
5S8W4_xx15DXR	9-36, 18-75	\pm 15	\pm 170	85	\pm 47

- X=2=2KVDC, X=4=4KVDC
- xx=Input Voltage
Vin=9-36V, xx=24
Vin=18-75V, xx=48

Functional block diagram

Functional Block Diagram

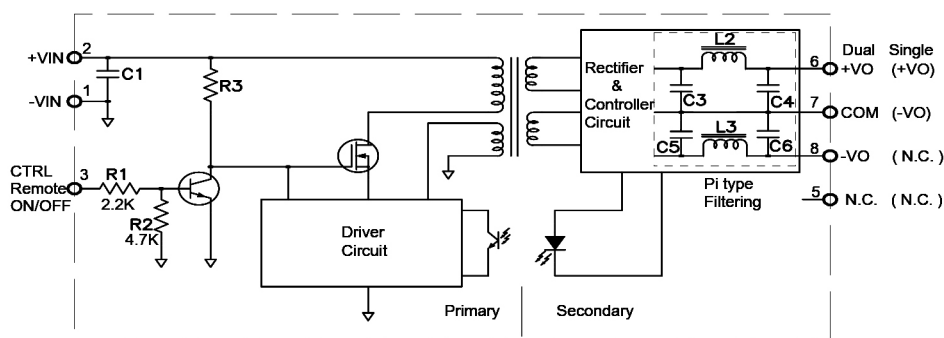

Input Voltage	C1 Values
9~36VDC	4.7 μ F/50V
36~75VDC	1 μ F/100V

Mechanical dimensions

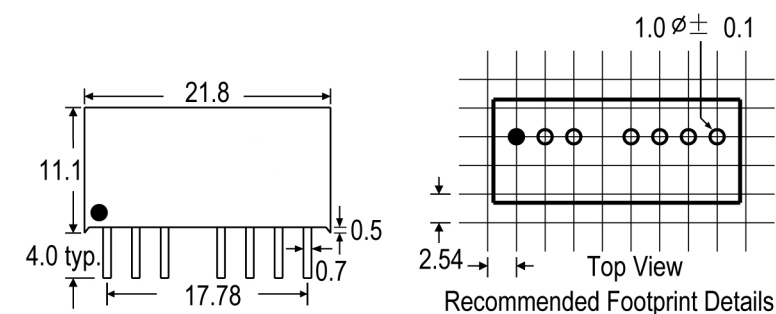

Pin Connections

Pin#	Single	Dual
1	-Vin	-Vin
2	+Vin	+Vin
3	CTRL	CTRL
5	NC	NC
6	+Vout	+Vout
7	-Vout	COM
8	NC	-Vout

NC=No Connection

CTRL=Remote ON/OFF Control

5S8W4_2RP Series

5W - Dual/Single Output - Wide Input - Isolated & Regulated
DC-DC Converter

Typical characteristics

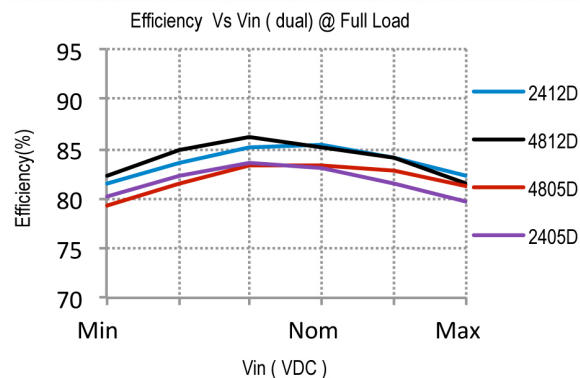
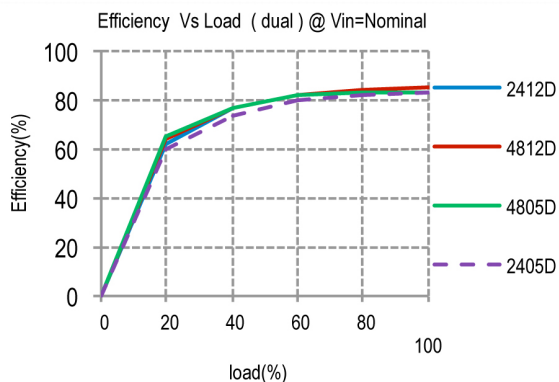
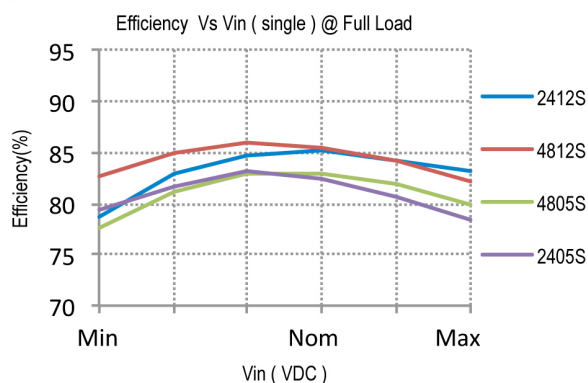
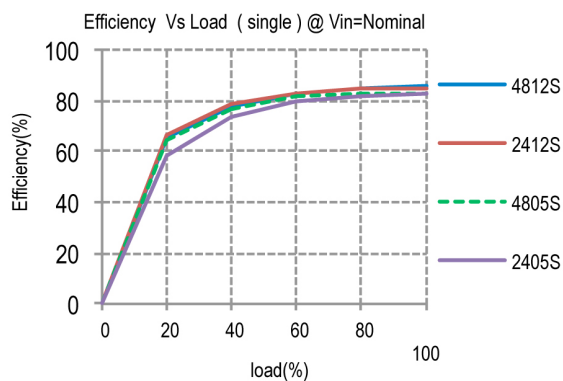
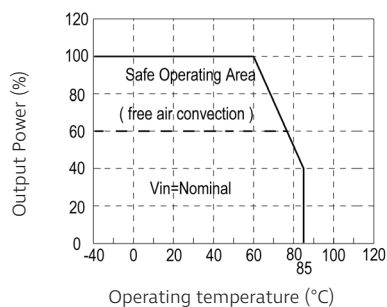

Tube outline

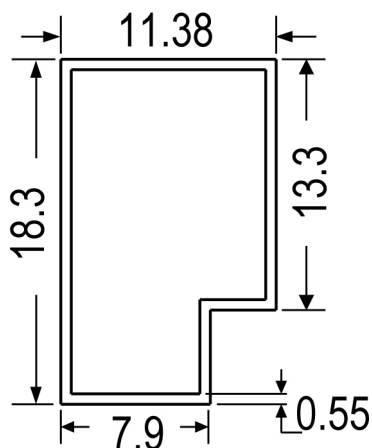

Note:
Unit: mm[inch]
General tolerances: ± 0.50 mm

L=520mm ± 2 mm
Tube quantity: 23pcs