

SIGN	DATE	DESCRIPTION	APPROVER
△			
△			
△			

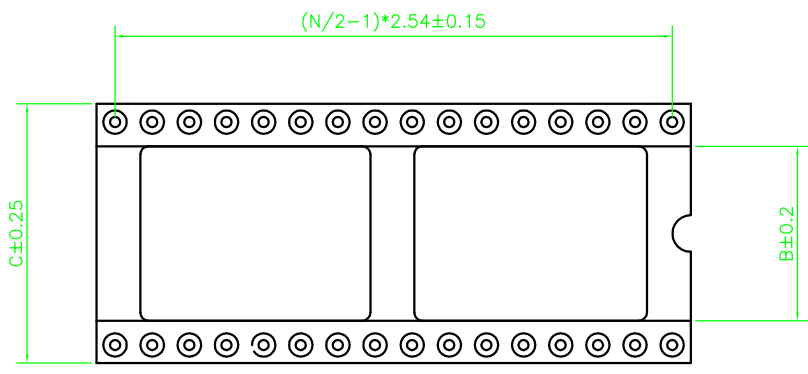
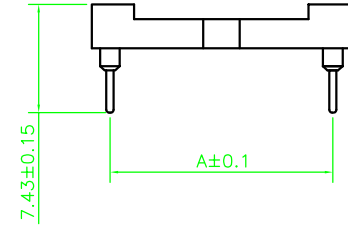
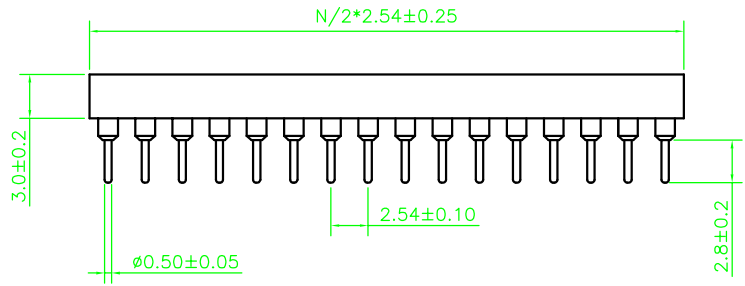

	三型	四型	六型	九型
A	7.62	10.16	15.24	22.86
B	4.14	6.68	11.76	19.38
C	10.12	12.66	17.74	25.36

1.ELECTRICAL:

Current rating:3.0Amps/Contact MAX
 Contact resistance:20mΩ/ Contact MAX
 Insulation resistance:1000MΩ at V=100V MIN
 Operating voltage:60V AC/DC

2.MECHANICAL

Average insertion force with steel pin of ø0.43mm:250g MAX
 Average with drawal force with steel pin of ø0.43mm:25G MIN
 Mechanical life cycle:200 cycle MIN
 Operating temperatures:
 Gold plated:-55°C to +125°C
 Tin plated:-40°C ti +105°C
 Soldering Temperature:PPS:+260°C,10S MAX
 PBT:+240°C,10S MAX

3.Material

PIN: Brass,machined
 CLIP: Beryllium Copper or Phosphor Bronze
 Plating(PIN):50u" Ni,100u" Sn(standard)
 Plating(Clip):50u" Ni,GOLD FLASH(standard)
 Insulator body(Black):PPS or other(UL94V-0)

Ordering Information

R - 1 0 0 - X X X - X X - 1001 - 00

RoHS		NUMBER OF PIN		Dip Spacing		Housing type		PITCH	
Code	Definition	Code	Number of PIN	Code	Definition	Code	Definition	Code	Definition
Blank	No-RoHS	06	6Pin	3	7.62	1	with bar	0	2.54
R	RoHS	4	10.16	2	without bar	7	1.778
		64	64Pin	6	15.24				
				9	22.86				

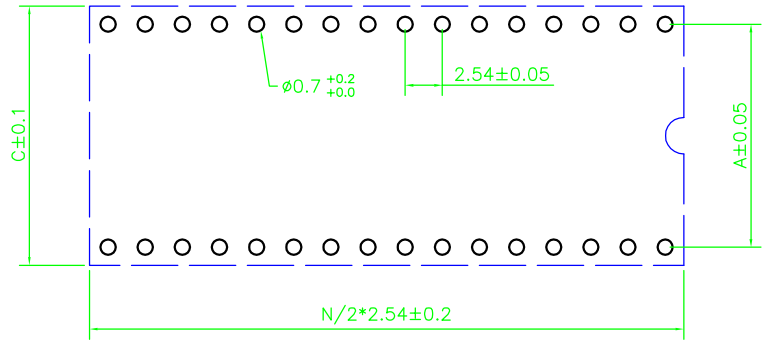

P.C. Board Layout

JHJM 深圳市君灏精密工业有限公司
 SHENZHEN JUNHAO ENGINEERING CO.,LTD

PART. NAME: XX芯X型圆孔IC插座系列				TITLE:	
PART. NO.: 100-326-100-1001-00				DWG NAME:	
APPROVED BY	CHECKED BY	DESIGNED BY	DRAWN BY	CUSTOM NO.:	Tolerance
			Jacky		x. ±0.50
				UNITS: mm	x.x ±0.30
				SCALE:	x.xx ±0.10
				REVISION:	xx° ±1°