



# WLL170T-2P460

WLL170-2

FIBER-OPTIC SENSORS AND FIBERS

**SICK**  
Sensor Intelligence.



Illustration may differ



### Ordering information

Type	Part no.
WLL170T-2P460	6033965

Other models and accessories → [www.sick.com/WLL170-2](http://www.sick.com/WLL170-2)

### Detailed technical data

#### Features

<b>Sensor/detection principle</b>	Fiber-optic photoelectric sensor
<b>Dimensions (W x H x D)</b>	10.5 mm x 35.5 mm x 83.7 mm
<b>Housing design (light emission)</b>	Rectangular
<b>Sensing range max.</b>	0 mm ... 1,500 mm, Through-beam system <sup>1)</sup>
<b>Sensing range</b>	0 mm ... 60 mm, Proximity system <sup>2) 3)</sup> 0 m ... 300 mm, Through-beam system <sup>4)</sup>
<b>Focus</b>	<sup>5)</sup>
<b>Type of light</b>	Visible red light
<b>Light source</b>	LED <sup>6)</sup>
<b>Angle of dispersion</b>	Approx. 65° <sup>5)</sup>
<b>Wave length</b>	660 nm
<b>Adjustment</b>	Single teach-in button Cable
<b>Time type</b>	Off delay
<b>Delay time</b>	Selectable by sliding switch, 40 ms
<b>Indication</b>	LED

<sup>1)</sup> LL3-TB02 and tip adapter LL3-TA01.

<sup>2)</sup> Objects to be sensed with 90% reflectivity (based on DIN 5033 white standard). Sensing range depends on fiber-optic cable.

<sup>3)</sup> LL3-DM01.

<sup>4)</sup> LL3-TB01.

<sup>5)</sup> See LL3 fiber-optic data.

<sup>6)</sup> Average service life: 100,000 h at T<sub>J</sub> = +25 °C.

## Mechanics/electronics

<b>Supply voltage</b>	10 V DC ... 30 V DC <sup>1)</sup>
<b>Ripple</b>	10 % <sup>2)</sup>
<b>Power consumption</b>	≤ 30 mA <sup>3)</sup>
<b>Output type</b>	PNP
<b>Number of switching outputs</b>	1
<b>Switching mode</b>	Light/dark switching
<b>Switching mode selector</b>	Selectable via light/dark selector
<b>Output current I<sub>max.</sub></b>	≤ 100 mA
<b>Response time</b>	≤ 50 μs <sup>4)</sup>
<b>Switching frequency</b>	10,000 Hz <sup>5)</sup>
<b>Input</b>	Teach-in input
<b>Connection type</b>	Connector M8, 4-pin
<b>Circuit protection</b>	A <sup>6)</sup> B <sup>7)</sup> C <sup>8)</sup> D <sup>9)</sup>
<b>Protection class</b>	III
<b>Weight</b>	60 g
<b>Housing material</b>	Plastic, ABS
<b>Enclosure rating</b>	IP66 <sup>10)</sup>
<b>Items supplied</b>	BEF-WLL170 mounting bracket
<b>Ambient operating temperature</b>	-25 °C ... +55 °C
<b>Ambient storage temperature</b>	-40 °C ... +70 °C
<b>UL File No.</b>	NRKH.E300503 & NRKH7.E300503

<sup>1)</sup> Limit values.

<sup>2)</sup> May not exceed or fall below U<sub>v</sub> tolerances.

<sup>3)</sup> Without load.

<sup>4)</sup> Signal transit time with resistive load.

<sup>5)</sup> With light/dark ratio 1:1.

<sup>6)</sup> A = V<sub>S</sub> connections reverse-polarity protected.

<sup>7)</sup> B = inputs and output reverse-polarity protected.

<sup>8)</sup> C = interference suppression.

<sup>9)</sup> D = outputs overcurrent and short-circuit protected.

<sup>10)</sup> With correctly attached fibre-optic cable LL3 and closed protection hood.

## Classifications

<b>ECl@ss 5.0</b>	27270905
<b>ECl@ss 5.1.4</b>	27270905
<b>ECl@ss 6.0</b>	27270905
<b>ECl@ss 6.2</b>	27270905
<b>ECl@ss 7.0</b>	27270905
<b>ECl@ss 8.0</b>	27270905
<b>ECl@ss 8.1</b>	27270905

<b>ECI@ss 9.0</b>	27270905
<b>ETIM 5.0</b>	EC002651
<b>ETIM 6.0</b>	EC002651
<b>UNSPSC 16.0901</b>	39121528

### Adjustments possible

WLL170T-2

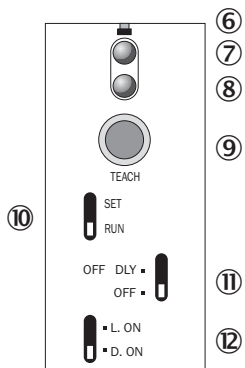

- ⑥ Indicating pin correctly inserted LL3 fiber
- ⑦ LED indicator orange: switching output active
- ⑧ LED signal strength indicator green, lights up, when light received < 0.9 or > 1.1 (switching threshold = 1)
- ⑨ Teach-in button
- ⑩ Operating mode selector switch: "SET" (Teach-in mode) / "RUN" (sensor mode)
- ⑪ OFF delay selector switch: "OFF DLY" (on) / "OFF" (off), 40 ms fixed
- ⑫ Selector switch: "L.ON" ( light switching) / "D.ON" ( dark switching)

### Connection diagram

Cd-092

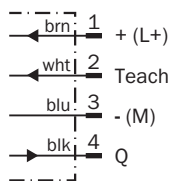

**Dimensional drawing** (Dimensions in mm (inch))



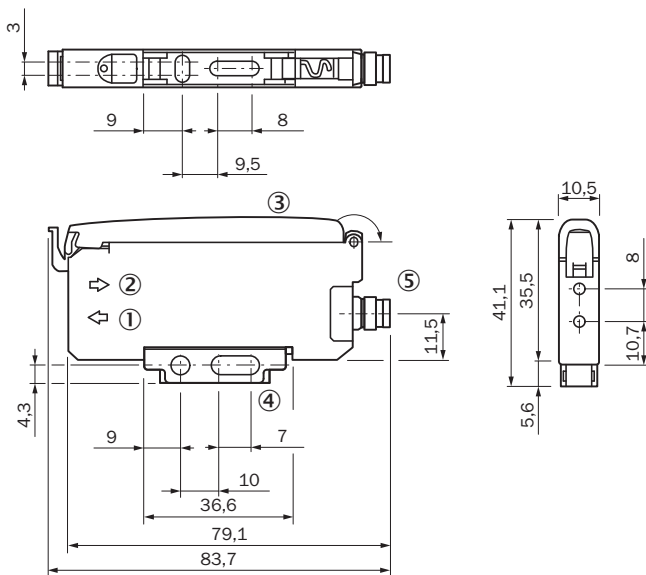

WLL170T-2



- ① Sender LED, installation of LL3 fibre-optic cable (sender fibre)
- ② Receiver, installation of LL3 fibre optic cable (receiver fibre)
- ③ Protective hood, can be raised at both ends
- ④ Mounting bracket, included with delivery
- ⑤ Connection

**Recommended accessories**

Other models and accessories → [www.sick.com/WLL170-2](http://www.sick.com/WLL170-2)

	Brief description	Type	Part no.
<b>Mounting brackets and plates</b>			
	Mounting bracket, steel, zinc coated, without mounting hardware	BEF-WLL170	5306574
<b>Other mounting accessories</b>			
	Rail end piece for block mounting, Stainless steel, mounting hardware included	BEF-EB01-W190	5313011
	Cutter for fibers, supplied with LL3	FC	5304141
<b>Plug connectors and cables</b>			
	Head A: female connector, M8, 4-pin, straight Head B: cable Cable: PVC, unshielded, 2 m	DOL-0804-G02M	6009870
	Head A: female connector, M8, 4-pin, straight Head B: cable Cable: PVC, unshielded, 5 m	DOL-0804-G05M	6009872

	Brief description	Type	Part no.
	Head A: female connector, M8, 4-pin, angled Head B: cable Cable: PVC, unshielded, 2 m	DOL-0804-W02M	6009871
	Head A: female connector, M8, 4-pin, angled Head B: cable Cable: PVC, unshielded, 5 m	DOL-0804-W05M	6009873
	Head A: male connector, M8, 4-pin, straight Head B: - Cable: unshielded	STE-0804-G	6037323

## SICK AT A GLANCE

SICK is one of the leading manufacturers of intelligent sensors and sensor solutions for industrial applications. A unique range of products and services creates the perfect basis for controlling processes securely and efficiently, protecting individuals from accidents and preventing damage to the environment.

We have extensive experience in a wide range of industries and understand their processes and requirements. With intelligent sensors, we can deliver exactly what our customers need. In application centers in Europe, Asia and North America, system solutions are tested and optimized in accordance with customer specifications. All this makes us a reliable supplier and development partner.

Comprehensive services complete our offering: SICK LifeTime Services provide support throughout the machine life cycle and ensure safety and productivity.

For us, that is “Sensor Intelligence.”

## WORLDWIDE PRESENCE:

Contacts and other locations –[www.sick.com](http://www.sick.com)