

SHINDENGEN

Super Fast Recovery Rectifiers

Single

DE3L20U

200V 3A

FEATURES

SMT
Low noise
trr35ns

APPLICATION

Switching power supply
DC/DC converter
Free Wheel
Home Appliances, Office Equipment
Telecommunication, Factory Automation

OUTLINE DIMENSIONS

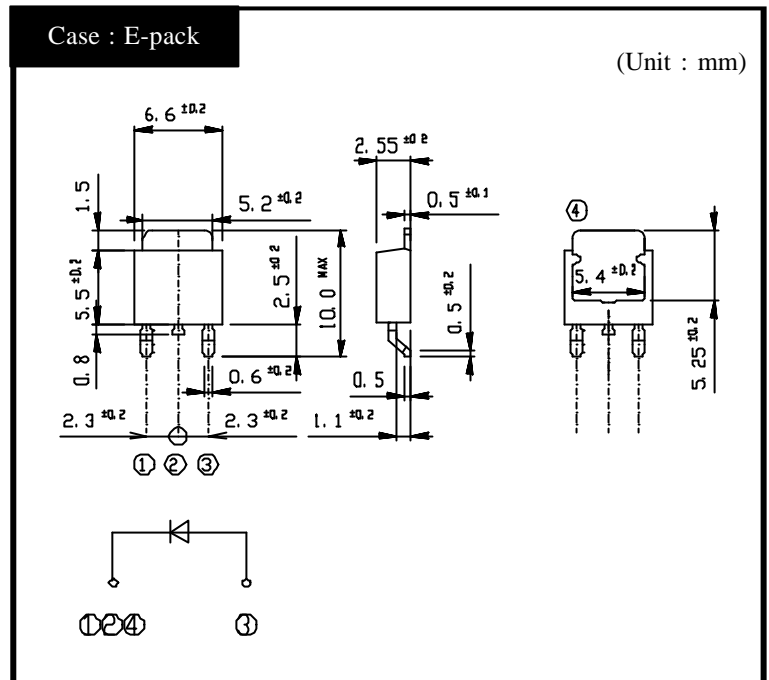

RATINGS

Absolute Maximum Ratings (If not specified Tc=25)

Item	Symbol	Conditions	Ratings	Unit
Storage Temperature	Tstg		-55 ~ 150	
Operating Junction Temperature	Tj		150	
Maximum Reverse Voltage	V _{RM}		200	V
Average Rectified Forward Current	I _O	50Hz sine wave, R-load, Tc=113	3	A
Peak Surge Forward Current	I _{FSM}	50Hz sine wave, Non-repetitive 1 cycle peak value, Tj=25	60	A

Electrical Characteristics (If not specified Tc=25)

Item	Symbol	Conditions	Ratings	Unit
Forward Voltage	V _F	I _F =3A, Pulse measurement	Max.0.98	V
Reverse Current	I _R	V _R =V _{RM} , Pulse measurement	Max.10	μA
Reverse Recovery Time	t _{rr}	I _F =0.5A, I _R =1A	Max.35	ns
Thermal Resistance	θ _{JC}	junction to case	Max.12	/W

DE3L20U

Forward Voltage

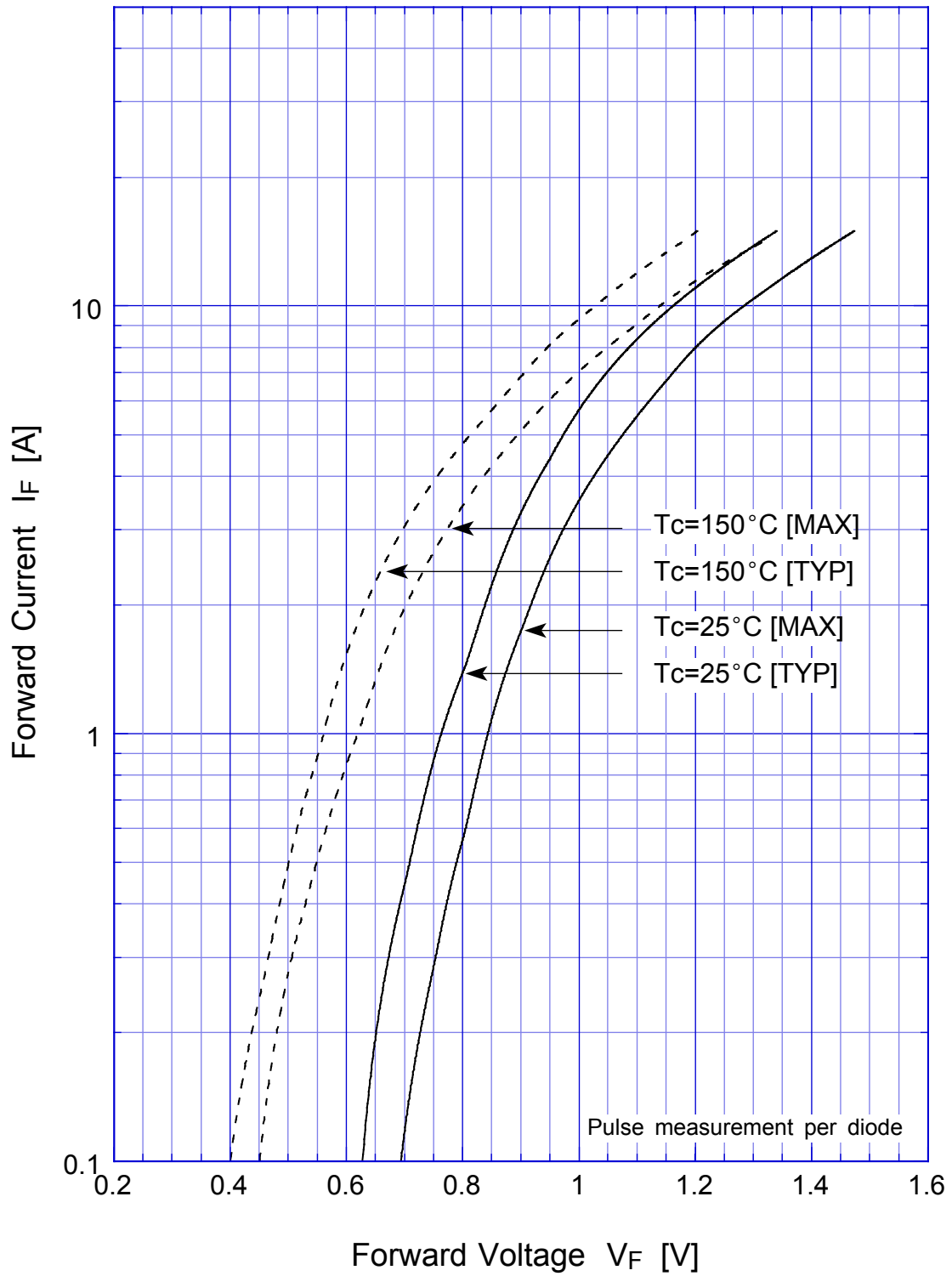

DE3L20U Forward Power Dissipation

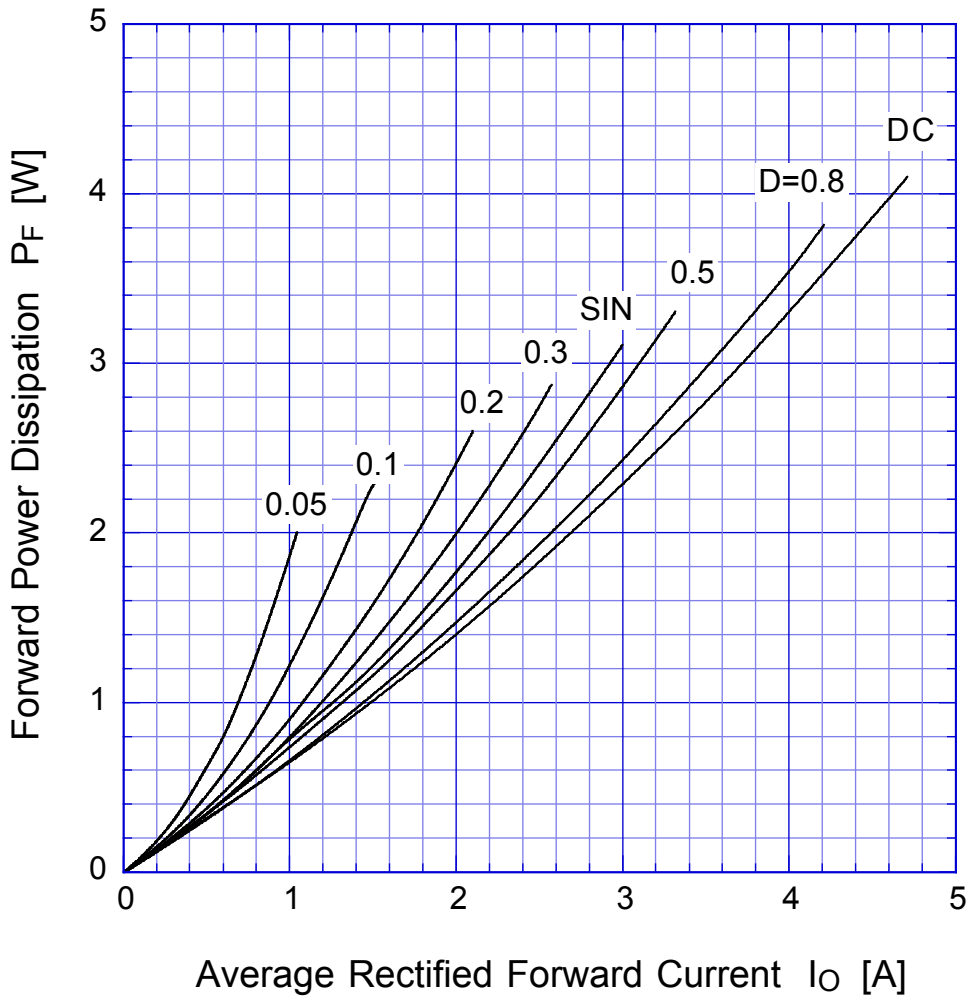

$T_j = 150^\circ\text{C}$

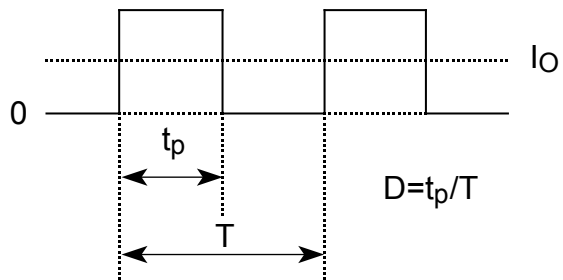

DE3L20U

Derating Curve

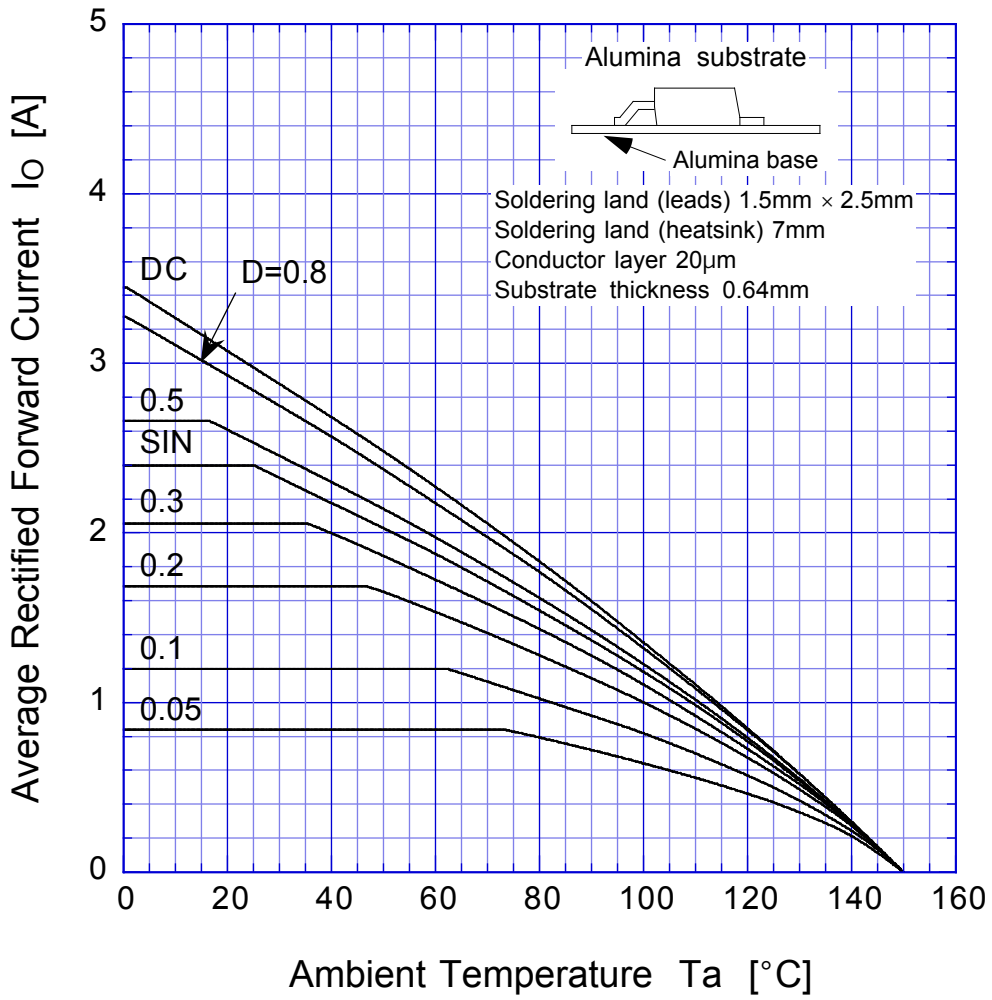

$V_R = 200V$



DE3L20U

Derating Curve

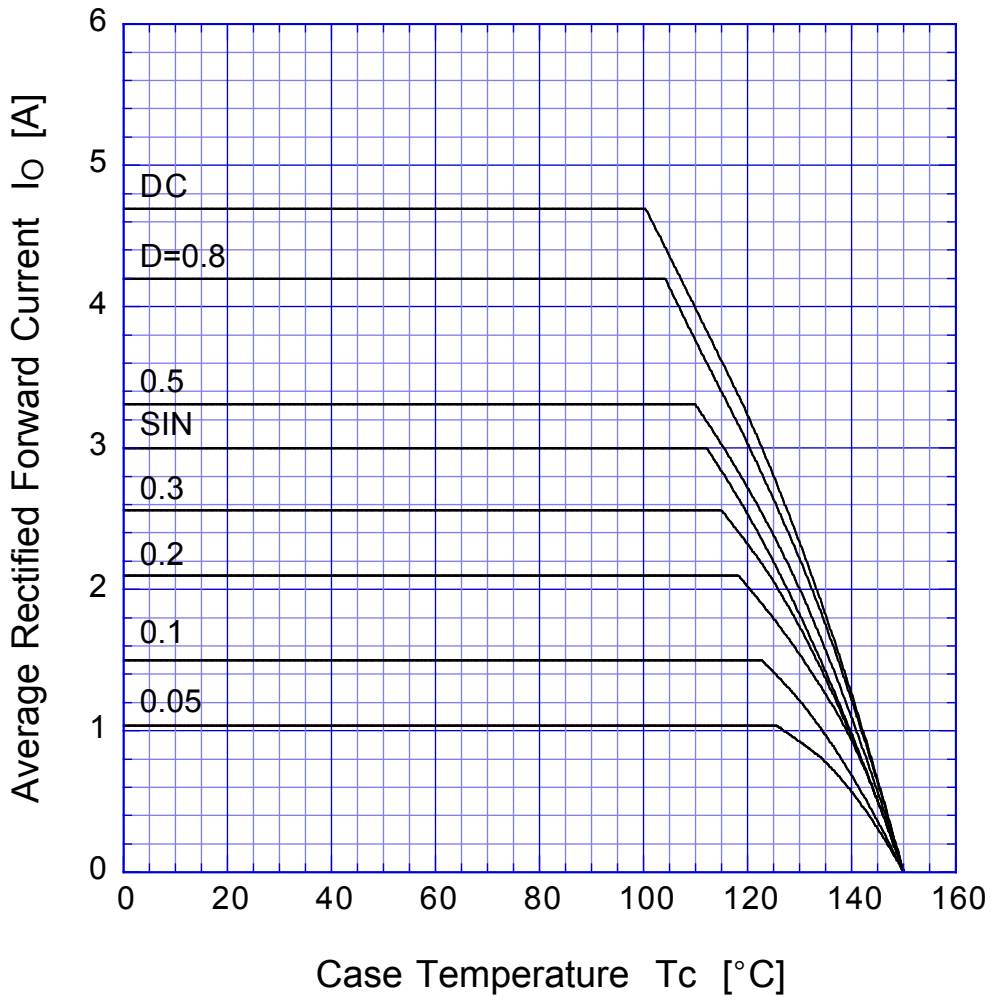

$V_R = 200V$

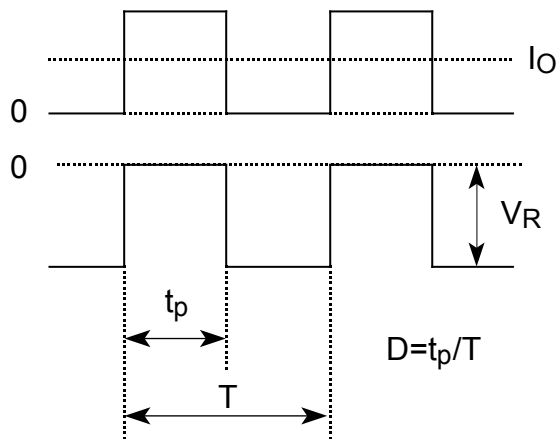

DE3L20U

Peak Surge Forward Capability

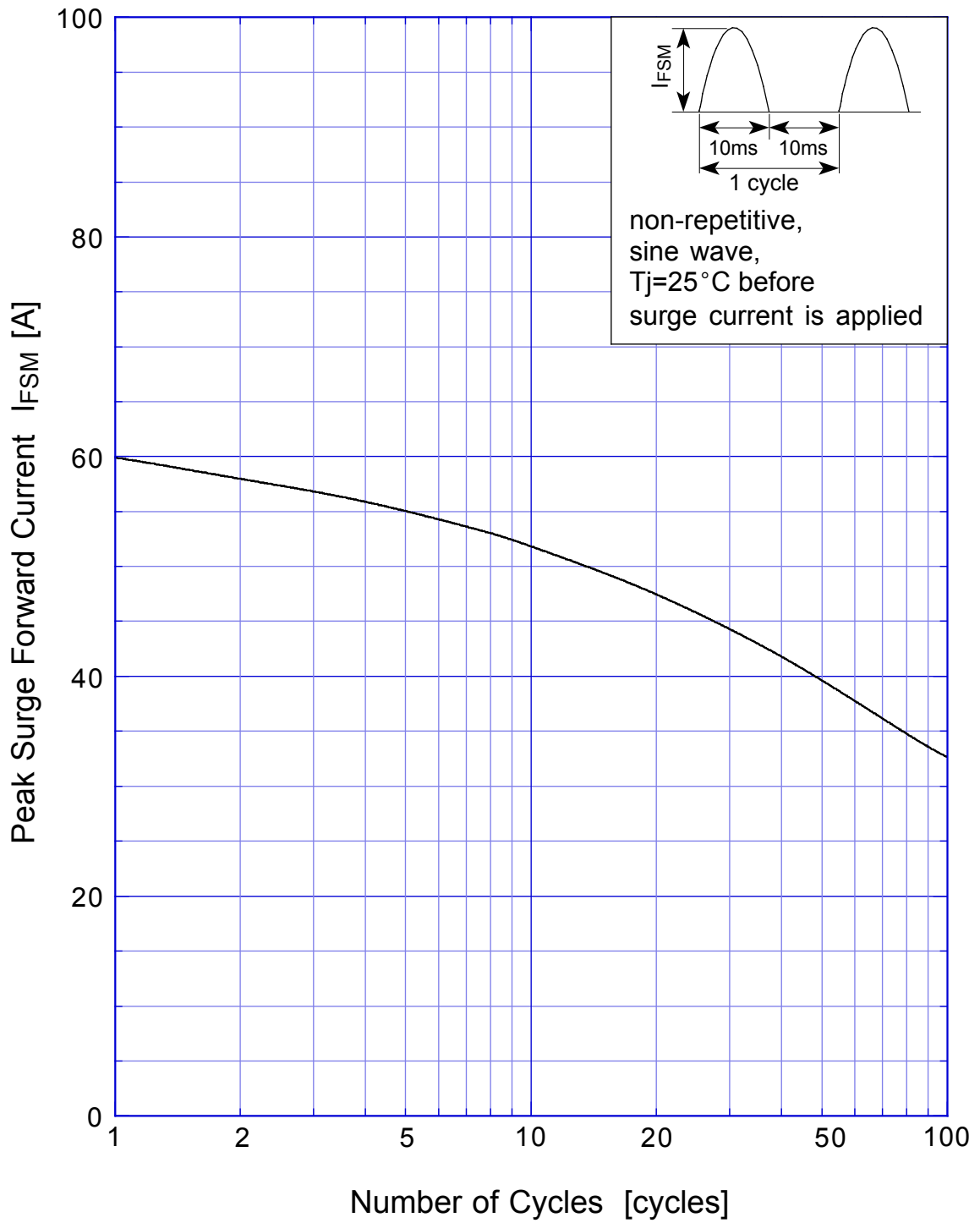

DE3L20U Junction Capacitance

