

SANYO

No.4298A

LA1831, 1831M

**Support for AM Stereo and Electronic Tuning
Single Chip Music Center IC (AM/FM IF + MPX)
for Use in Compact Radio/Cassette Products**

Overview

The LA1831 is a single chip AM/FM IF and MPX tuner IC that supports electronic tuning. This chip was developed for consumer audio systems and is optimal for auto-seek systems based on IF count methods used together with SD.

Since no adjustments are required in the FM detector and MPX VCO circuits, use of this chip can significantly reduce the number of adjustment steps in the end-product manufacturing line.

Functions

AM: RF amplifier, mixer, oscillator (with ALC), IF amplifier, detector AGC, oscillator buffer, tuning indicator, IF buffer output, stereo IF output.

FM IF: IF amplifier, quadrature detector, S curve detection, tuning indicator, IF buffer output, S-meter

MPX: PLL stereo decoder, stereo indicator, force to mono, VCO stop

Features

- Major reduction in required adjustments
 - FM detector: No adjustments (ceramic discriminator used)
 - MPX VCO: No adjustments (ceramic resonator used)
- Tuning indicator pin provided (can be used as a narrow bandwidth stop signal or a muting drive output): SD output
- Supports IF count methods
- Variable FM stop sensitivity and bandwidth
- Built-in AM local oscillator buffer
- Supports AM low-cut control
- Pin compatible with the LA1830 (only the DIP version, the LA1831M is a new product)
- Built-in IF output function for AM stereo

Specifications

Maximum Ratings at $T_a = 25^\circ\text{C}$

Parameter	Symbol	Condition	Rating	Unit
Maximum supply voltage	$V_{CC \text{ max}}$		9.0	V
Indicator drive current	I_{LED}	Pins 6 and 7	20	mA
Allowable power dissipation	$P_d \text{ max}$	$T_a \leq 70^\circ\text{C}$ (LA1831)	400	mW
		$T_a = 70^\circ\text{C}$ (LA1831M)	270	mW
Operating temperature	T_{opF}		-20 to +70	$^\circ\text{C}$
Storage temperature	T_{stg}		-40 to +125	$^\circ\text{C}$

Package Dimensions

unit: mm

3067-DIP24S (LA1831)

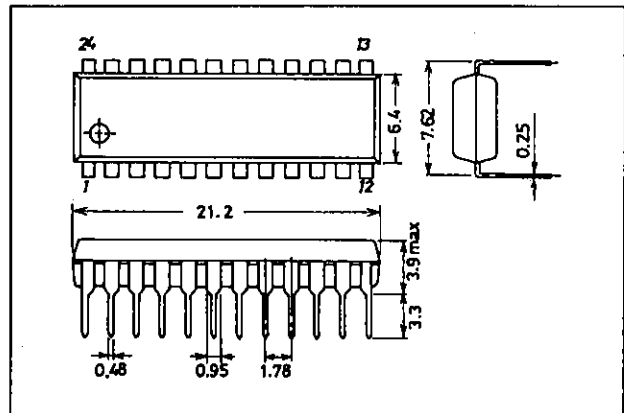

3112-MFP24S (LA1831M)

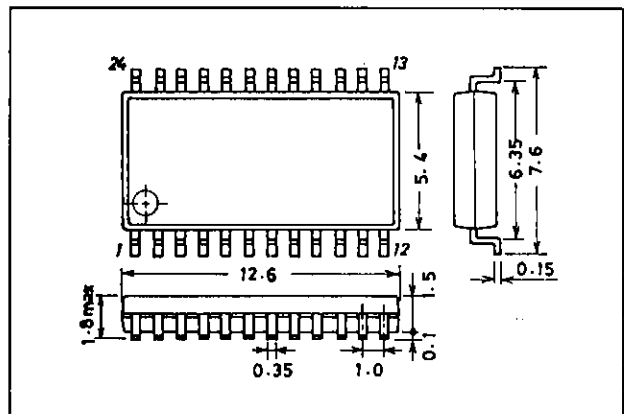

SANYO Electric Co., Ltd. Semiconductor Business Headquarters

TOKYO OFFICE Tokyo Bldg., 1-10, 1 Chome, Ueno, Taito-ku, TOKYO, 110 JAPAN

LA1831, 1831M

Operating conditions at $T_a = 25^\circ\text{C}$

Parameter	Symbol	Rating	Unit
Recommended supply voltage	V_{CC}	5.0	V
Operating supply voltage range	$V_{CC\text{ op}}$	4.0 to 8.0	V

Operating Characteristics, at $T_a = 25^\circ\text{C}$, $V_{CC} = 5.0\text{ V}$, (for the specified test circuits)

FM Characteristics (mono): $f_c = 10.7\text{ MHz}$, $f_m = 1\text{ kHz}$

Parameter	Symbol	Condition	Ratings			Unit
			min	typ	max	
Quiescent current	I_{CCO-FM}	No input 19	12	23	33	mA
Demodulation output	V_{O-FM}	100 dB μ , 100% mod, pin 14 output	290	410	580	mVrms
Channel balance	C.B	100 dB μ , 100% mod, ratio of pin 14 to pin 15	-1.5	0	1.5	dB
Total harmonic distortion (mono)	THD-FMmono	100 dB μ , 100% mod, pin 14 output		0.3	1.5	%
Signal to noise ratio	S/N-FM	100 dB μ , 100% mod, pin 14 output	68	75		dB
Input limiting voltage	-3 dB L.S	With an input reference of 100 dB μ , the IF input that reduces the output by 3 dB		32	40	dB μ
LED sensitivity	$V_{LED-SENS}$	The IF input that turns the TU LED on	35	45	55	dB μ
LED bandwidth	LED-BAND	The frequency bandwidth that turns the TU LED on	70	110	160	kHz
IF count buffer output	$V_{IFBUFF-FM}$	The pin 10 output for 100 dB μ , no modulation	75	110	150	mVrms

FM Characteristics (stereo): $f_c = 10.7\text{ MHz}$, $f_m = 1\text{ kHz}$, $L + R = 90\%$, $PILOT = 10\%$, $V_{IN} = 100\text{ dB}\mu$

Parameter	Symbol	Condition	Ratings			Unit
			min	typ	max	
Separation	Sep	Pin 14 output	30	45		dB
Stereo on level	ST-ON	The pilot modulation level for which V_y becomes less than 1.5 V	1.5	3.0	5.0	%
Total harmonic distortion (main)	THD-Main	Pin 14 output		0.3	1.5	%

AM Characteristics: $f_c = 1000\text{ kHz}$, $f_m = 1\text{ kHz}$, 30% modulation

Parameter	Symbol	Condition	Ratings			Unit
			min	typ	max	
Quiescent current	I_{CCO-AM}	No input 19	10	20	33	mA
Detector output	V_{O1}	23 dB μ , pin 14 output	25	50	100	mVrms
	V_{O2}	80 dB μ , pin 14 output	80	130	200	mVrms
Signal to noise ratio	S/N 1	23 dB μ , pin 14 output	16	20		dB
	S/N 2	80 dB μ , pin 14 output	48	54		dB
Total harmonic distortion	THD-AM	80 dB μ , pin 14 output		0.3	1.0	%
		100 dB μ , pin 14 output		0.4	1.2	%
LED sensitivity	$V_{LED-SENS}$	The ANT input level at which the TU LED turns on	19	29	39	dB μ
Local oscillator buffer output	V_{OSC-AM}	No input, pin 24 output	140	200		mVrms
Low band attenuation	LOW-CUT	Output when $f_m = 100\text{ Hz}$, for a $f_m = 1\text{ kHz}$ reference	7	9	13	dB
IF count buffer output	$V_{IFBUFF-AM}$	80 dB μ , no modulation, pin 10 output	125	180	250	mVrms
Stereo IF output	$V_{ST-IF-AM}$	80 dB μ , no modulation, pin 7 output	7.0	15.0		mVrms

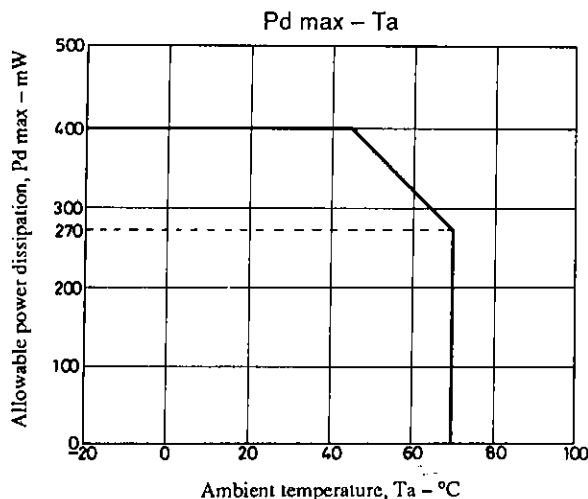

Equivalent Circuit Diagram

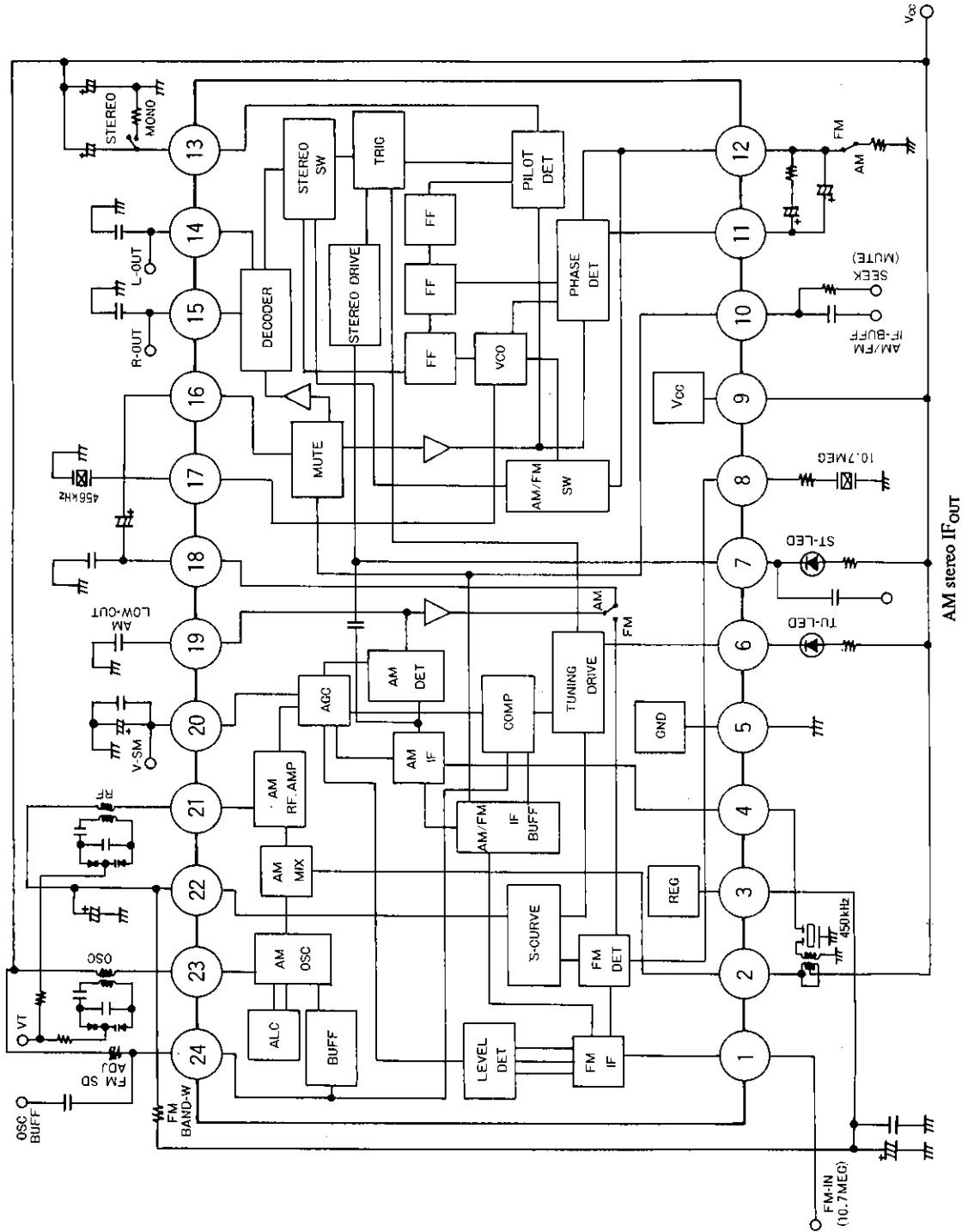

Test Circuit Diagram

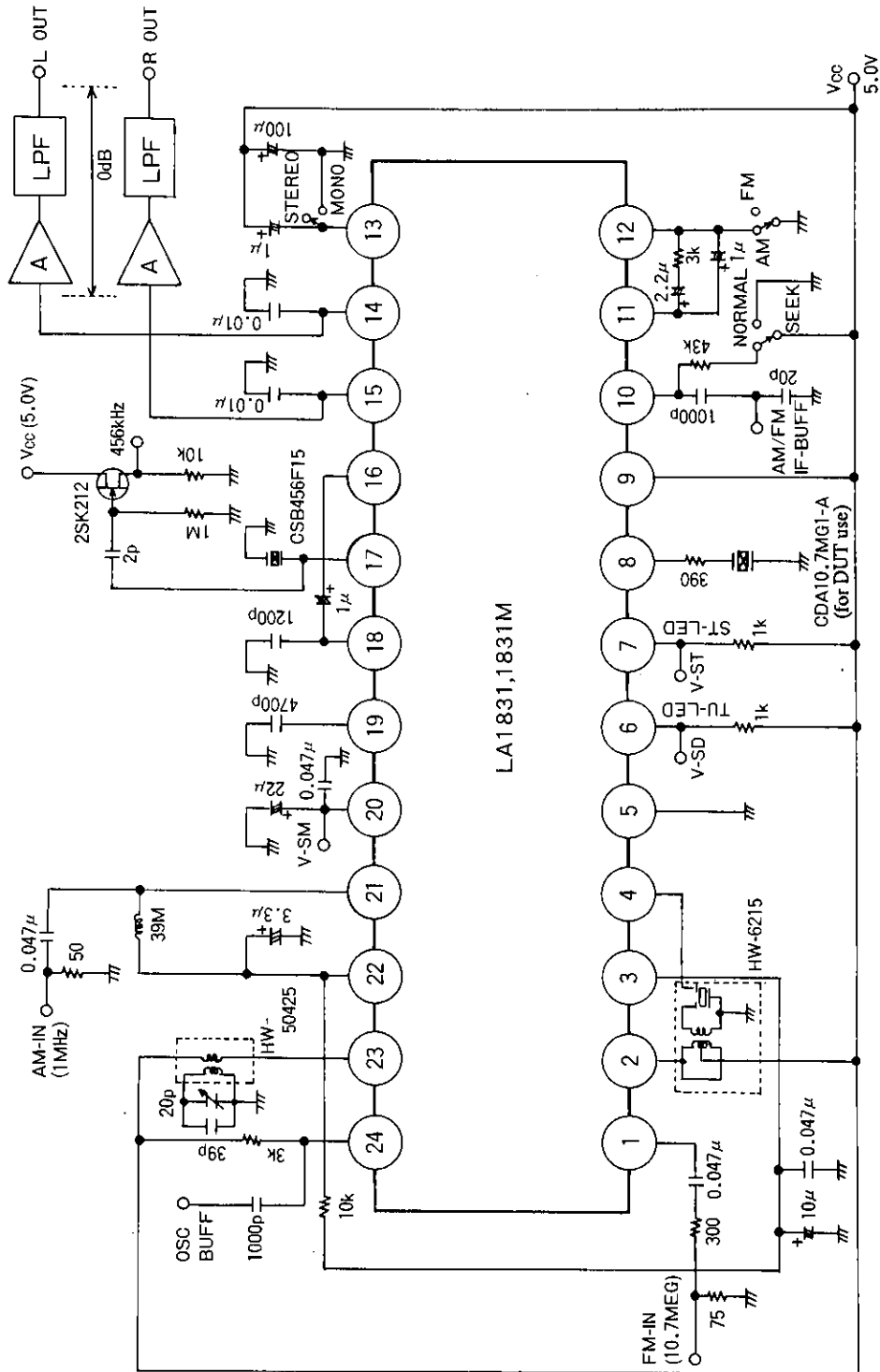

Unit (resistance: Ω, capacitance: F)

Pin Functions and No-Signal Voltages

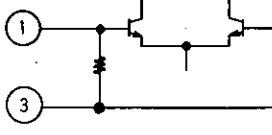
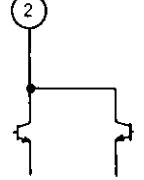
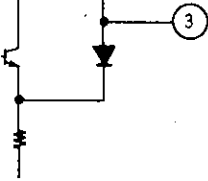
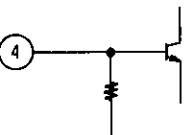
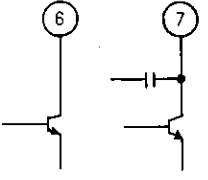
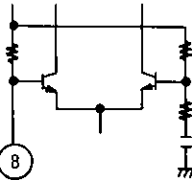
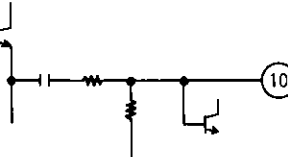
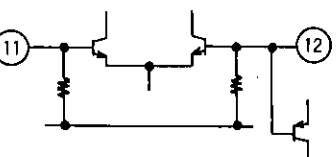
No.	Function	Pin voltage (V)	Equivalent circuit	Notes
1	FM IF input	2.1		Input impedance $r_i = 330 \Omega$
2	AM MIX output	5.0		Used for the MIX coil between pin 2 and pin 9 (the V_{CC} voltage)
3	REG	2.1		$V_{reg} = 2.1 V$
4	AM IF input	2.1		Input impedance $r_i = 2 k\Omega$
5	GND	0		
6	Tu-LED	5.0		Active-(L)
7	IF output for ST-LED and AM stereo			Open collector
8	FM-DET	2.8 (FM) 3.4 (AM)		Recommended ceramic discriminator: CDA10.7MG43 (Murata, Ltd)
9	V_{CC}	5.0		
10	AM/FM IF count output control SW, and mute SW	0		IF count and mute are turned on when $V_{IO} > 3.0 V$ Note: During seek, the IF buffer is output only in the SD on state.
11	Phase comparator filter pin, and AM/FM switch	Pin 11 3.8 (FM) 1.5 (AM)		AM mode is selected when over $200 \mu A$ flows from pin 12
12		Pin 12 3.8 (FM) 0 (AM)		

Continued on next page.

LA1831, 1831M

Continued from preceding page.

No.	Function	Pin voltage (V)	Equivalent circuit	Notes
13	Pilot detector filter pin, force to mono, VCO stop	3.5		Mode forced to mono when over 50 μ A flows from this pin The VCO stops at currents over 200 μ A
14	Left output	1.2		Output impedance $r_o = 5 \text{ k}\Omega$
15	Right output			
16	MPX input	2.1		Input impedance $r_i = 20 \text{ k}\Omega$
17	MPX VCO	2.4 (FM) 0 (AM)		Recommended ceramic oscillator: CSB456F15 (Murata, Ltd)
18	AM/FM demodulator output	2.1 (FM) 1.3 (AM)		Output impedance FM: $r_o = 2.3 \text{ k}\Omega$ AM: $r_o = 10 \text{ k}\Omega$
19	AM LOW CUT	1.5 (FM) 2.0 (AM)		The low band frequency characteristics are changed by an external capacitor connected at pin 19
20	S-meter, AM AGC	0.2 (FM) 0.6 (AM)		Built-in load resistance: $R = 13.9 \text{ k}\Omega$ An external capacitor connected at pin 20 determines the seek time SD response speed
21	AM RF-IN	2.1		Pin 21 is used at the same potential as pin 22 (the AFC voltage)
22	AFC	2.1		The FM-SD bandwidth can be changed with an external resistor connected between pin 22 and pin 3 Note: A setting of 180 kHz or higher is recommended for the FM-SD bandwidth.

Continued on next page.

Continued from preceding page.

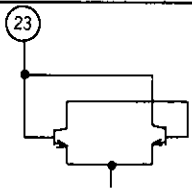
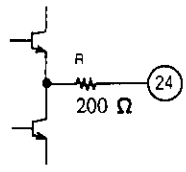
No.	Function	Pin voltage (V)	Equivalent circuit	Notes
23	OSC	5.0		An oscillator coil is used between pin 23 and pin 9 (the V _{CC} voltage) Note: An oscillator coil with an impedance of 5 kΩ or over (secondary side) should be used.
24	OSC buffer, FM SD adj.	3.6		The FM SD sensitivity can be changed with an external resistor connected at pin 24 Note: A resistor of 3 kΩ or over should be used for the pin 24 external resistor.

Coil Specifications

AM ANT BLOCK

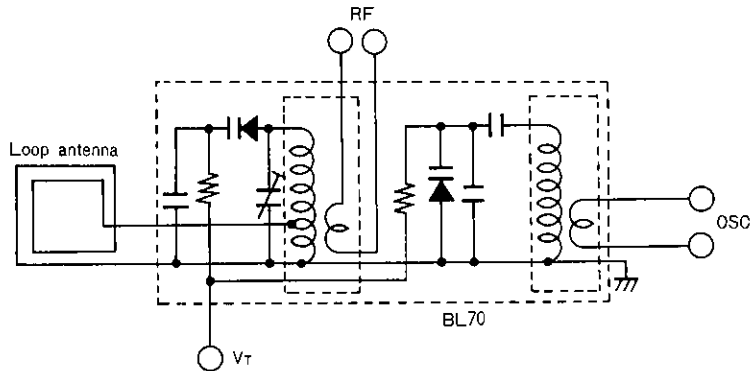

Loop antenna

- LA300 (Kohringiken, Ltd.)

Loop antenna matching coil

- KL-412 (Kohringiken, Ltd.) (for use with the SVC321)
- KO-387 (Kohringiken, Ltd.) (for SVC321 use)

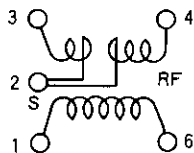

①-⑥ 15.5T
 ③-② 7T
 ②-④ 58T
 $Q_0 = 200 \pm 20\%$
 $L = 248 \mu\text{H} \pm 10\%$

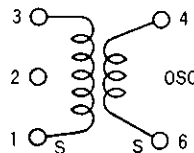

①-③ 48T
 ④-⑥ 20T
 $Q_0 = 150 \pm 20\%$

Continued on next page.

- AM OSC (for DUT use)
HW-50425 (Mitsumi, Ltd.)

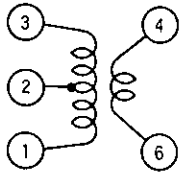

③-② 2T
④-⑥ 9T
②-① 86T
 $Q_0 \geq 80$
 $L = 270 \mu\text{H}$

- IFT
YD-1073-1 (Mitsumi, Ltd.)

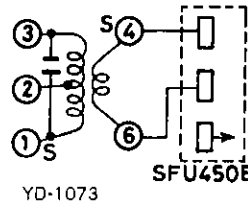

①-② 58T
④-⑥ 7T
②-③ 94T
 $f_0 = 450 \text{ kHz}$
 $Q_0 = 110$
180 pF internal
SFU 450B

- IFT (for DUT use)
HW-6215 (Mitsumi, Ltd.)

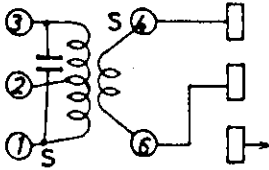

HW-6194
SFU-450B
①-② 94T
④-⑥ 7T
②-③ 58T
180 p

- FM DET
7KL-7252 (Toko, Ltd.)

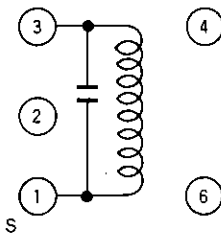
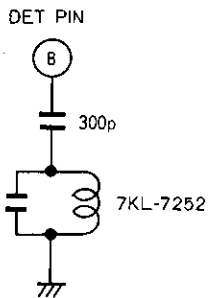

①-③ 15T
 $f_0 = 10.7 \text{ MHz}$
 $Q_0 = 85 \pm 20\%$
12 pF internal

Unit (capacitance: F)

- Application circuit using an FM detector coil

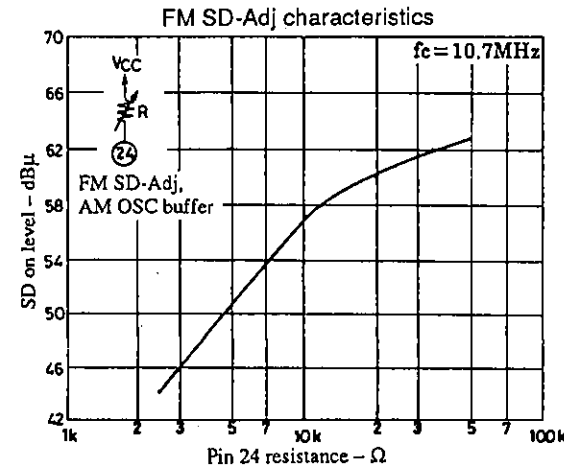
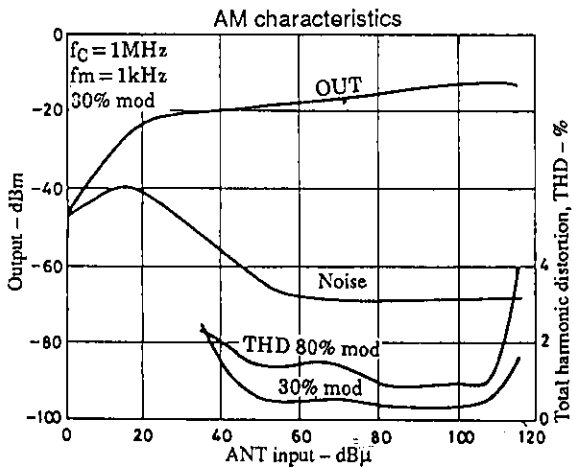
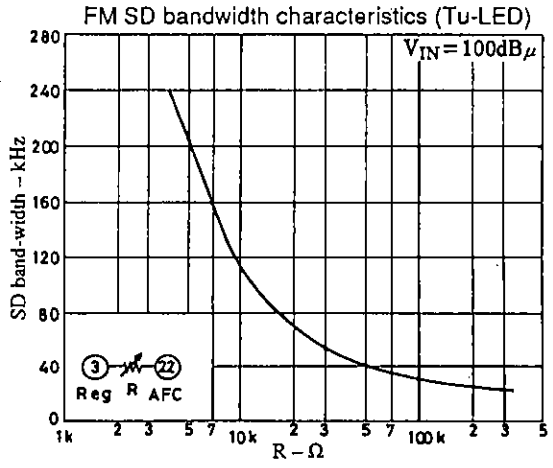
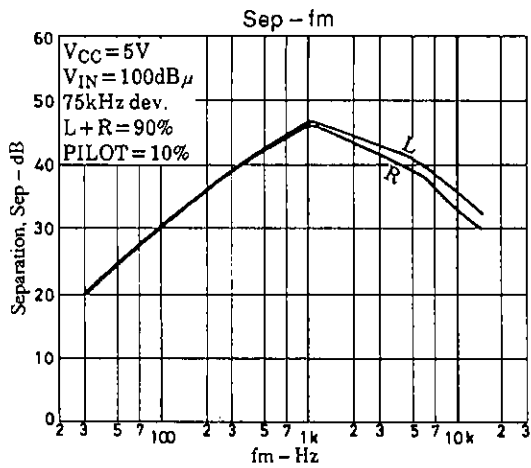
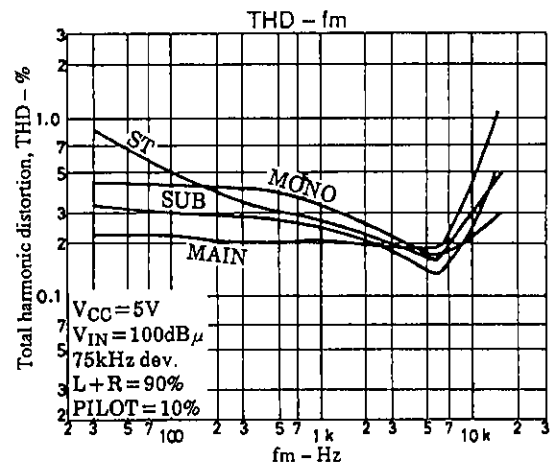
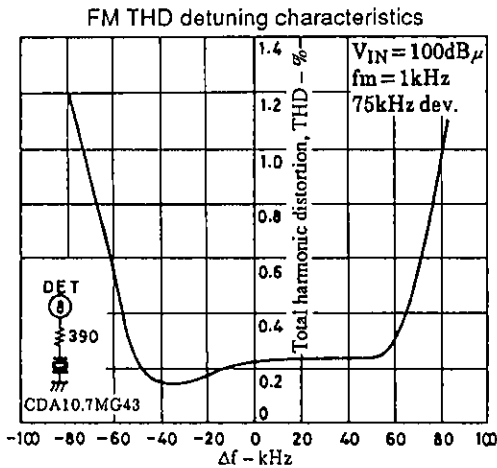
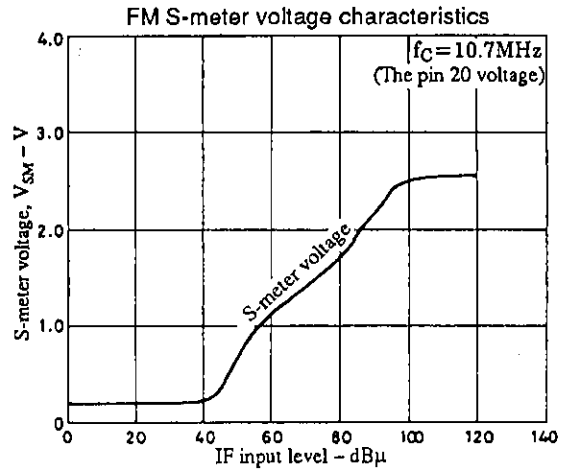
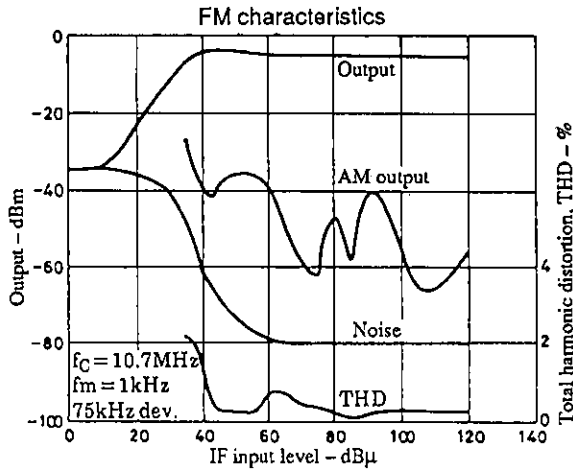

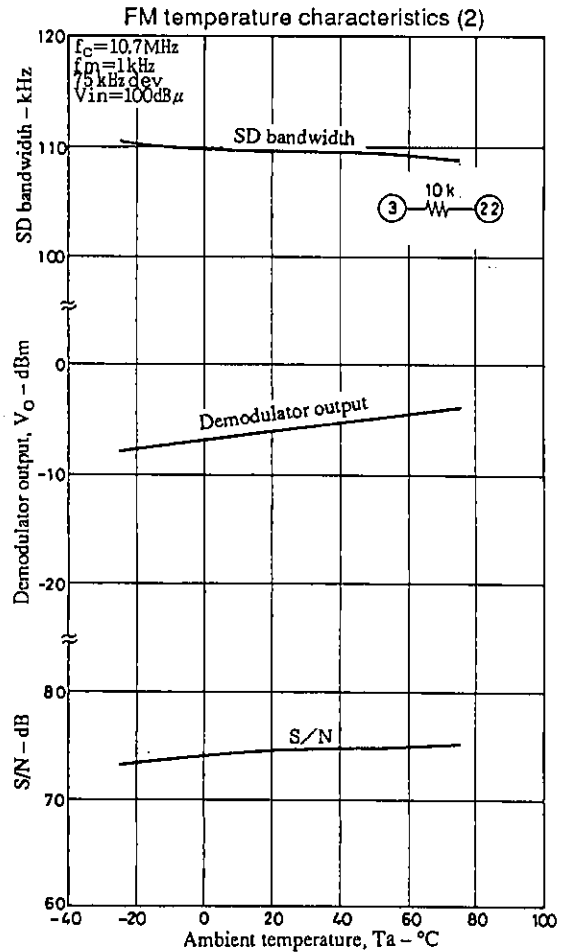
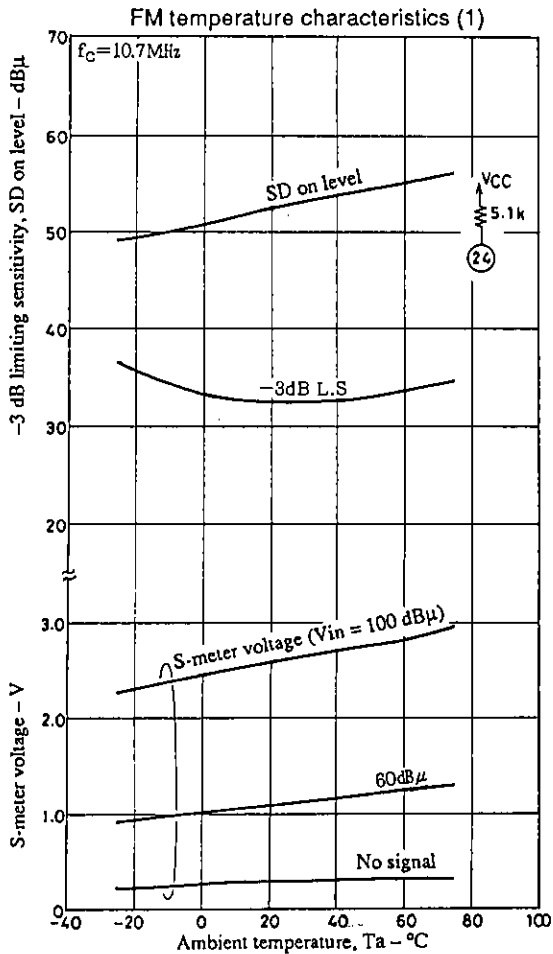
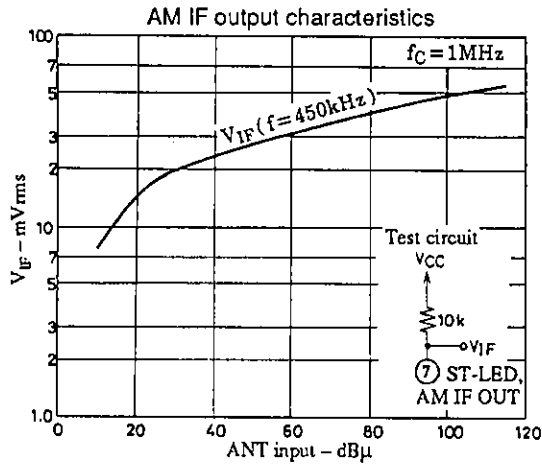
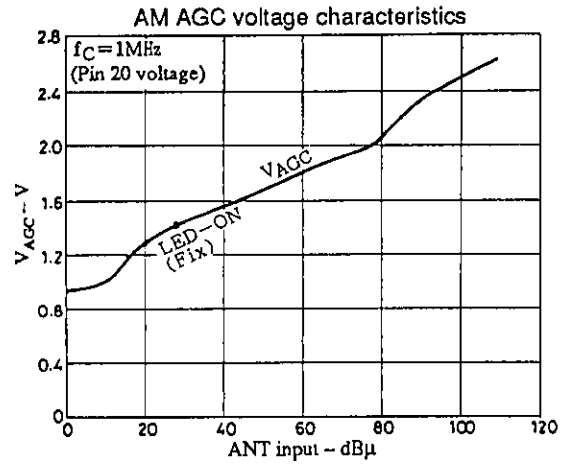
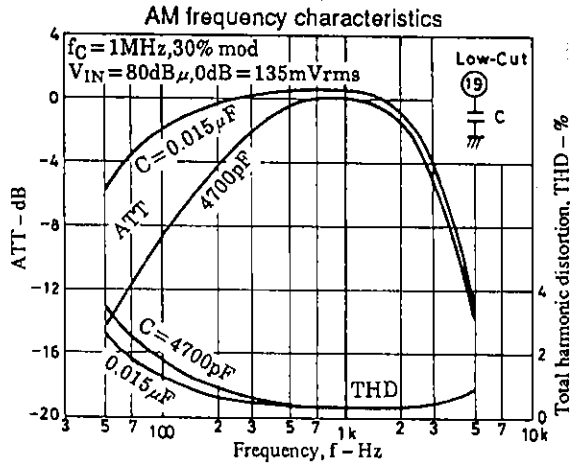

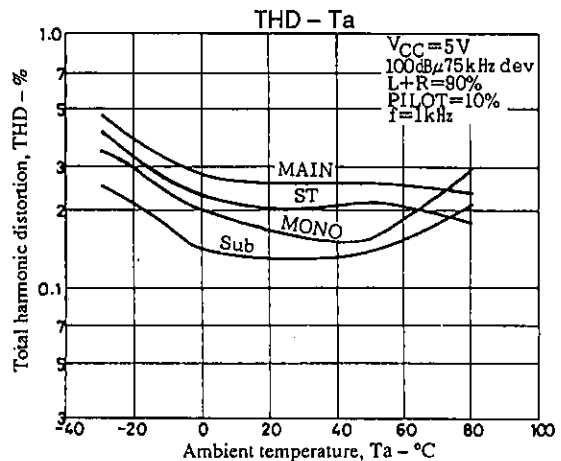
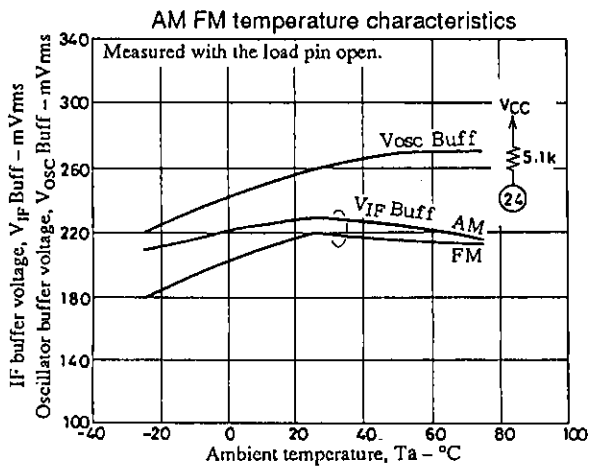
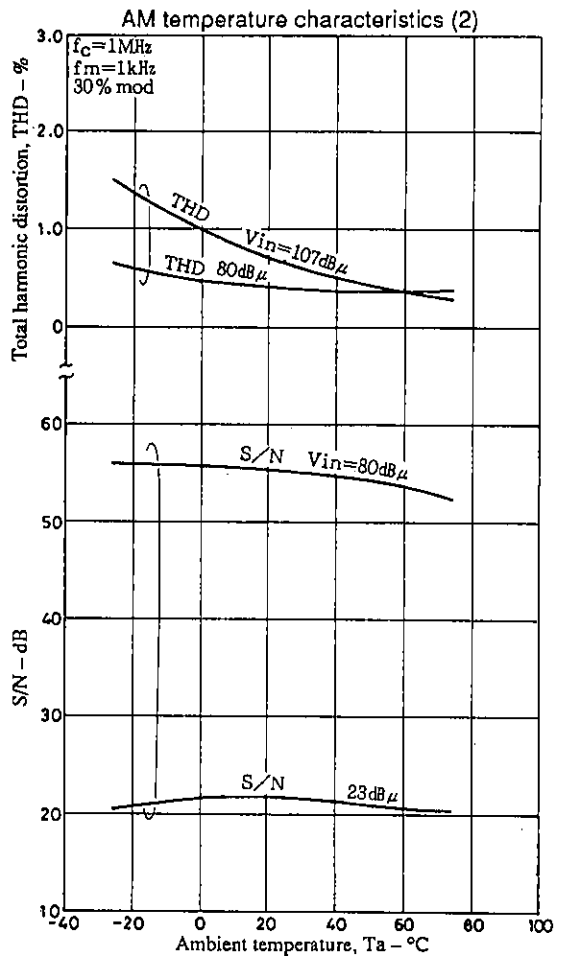
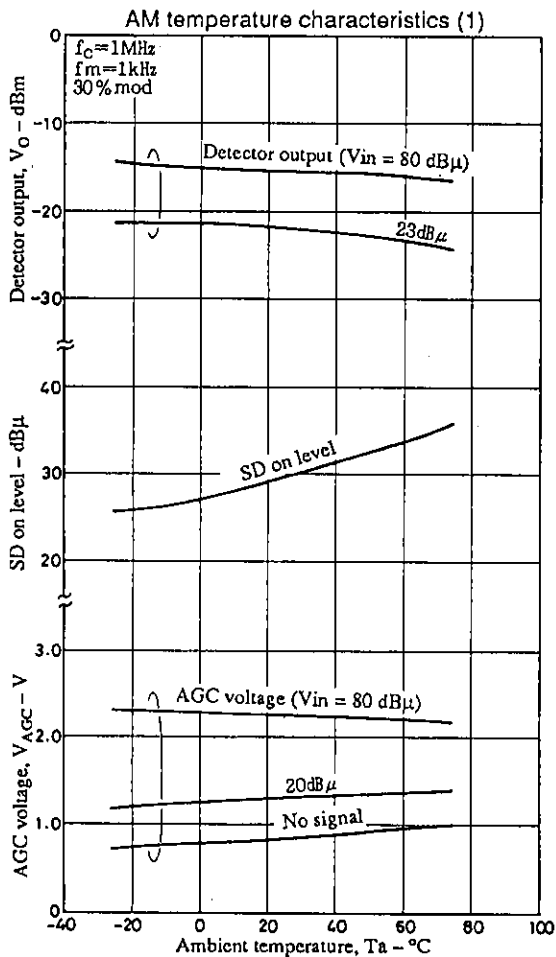
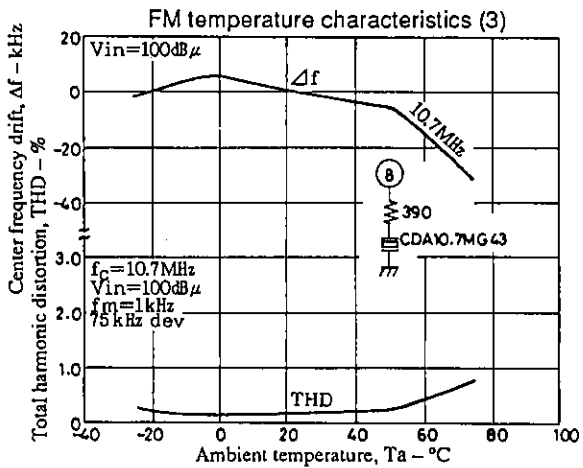

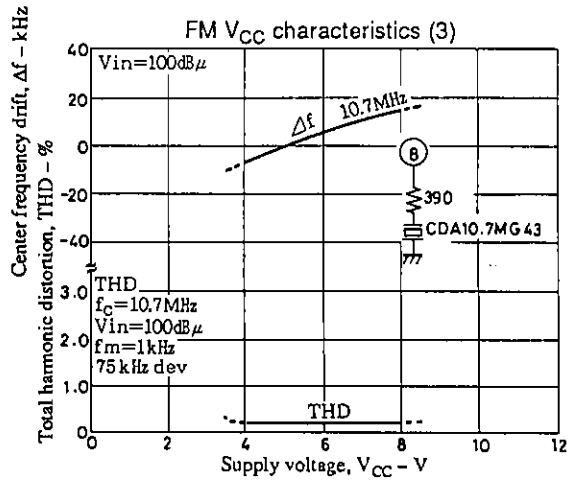
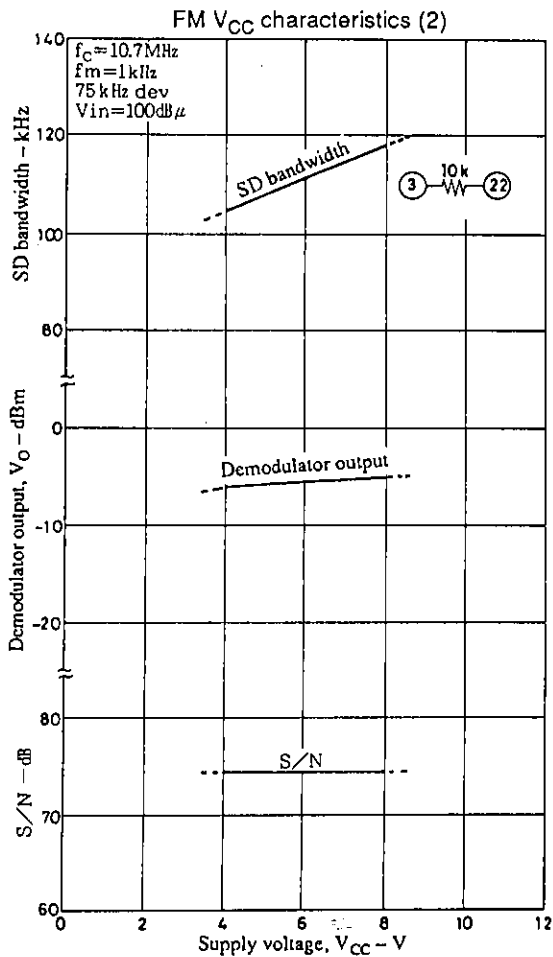
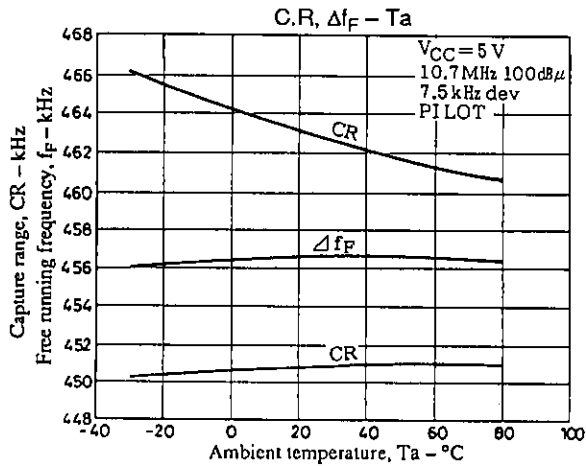
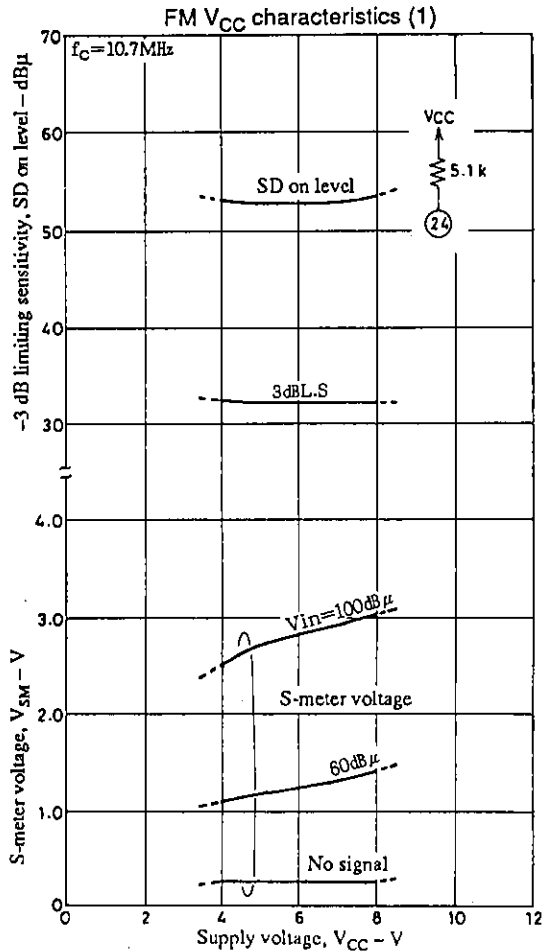
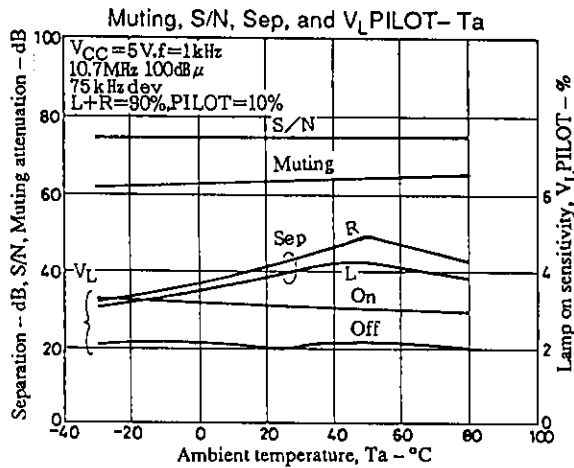

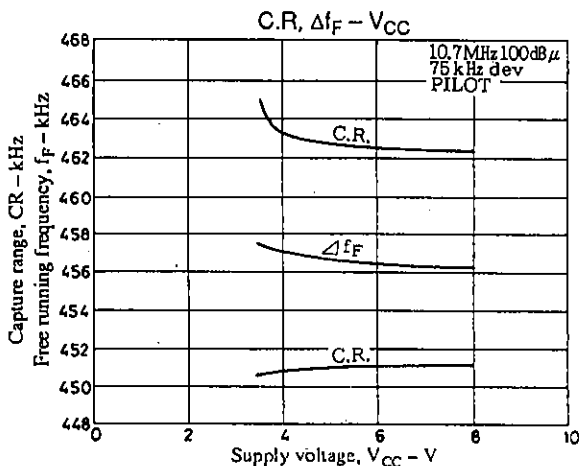
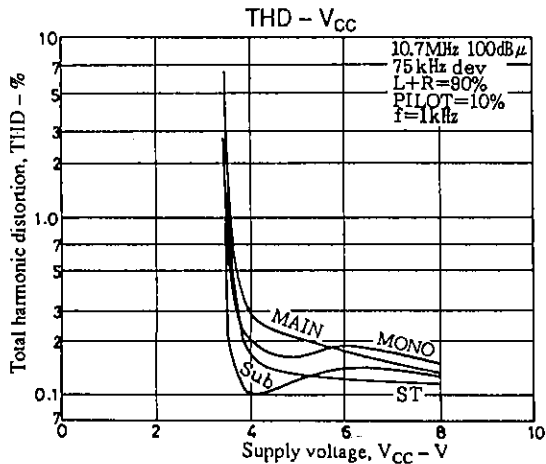
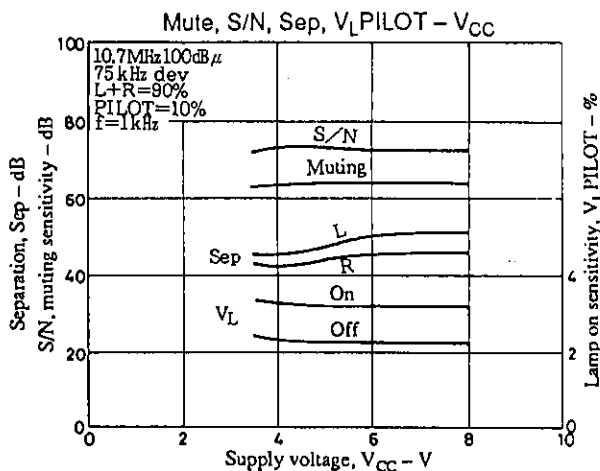
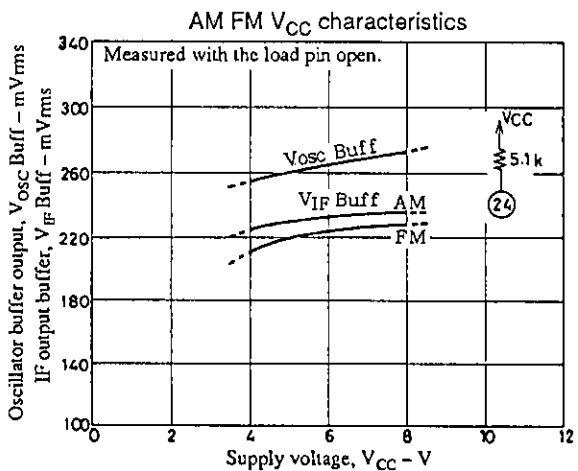
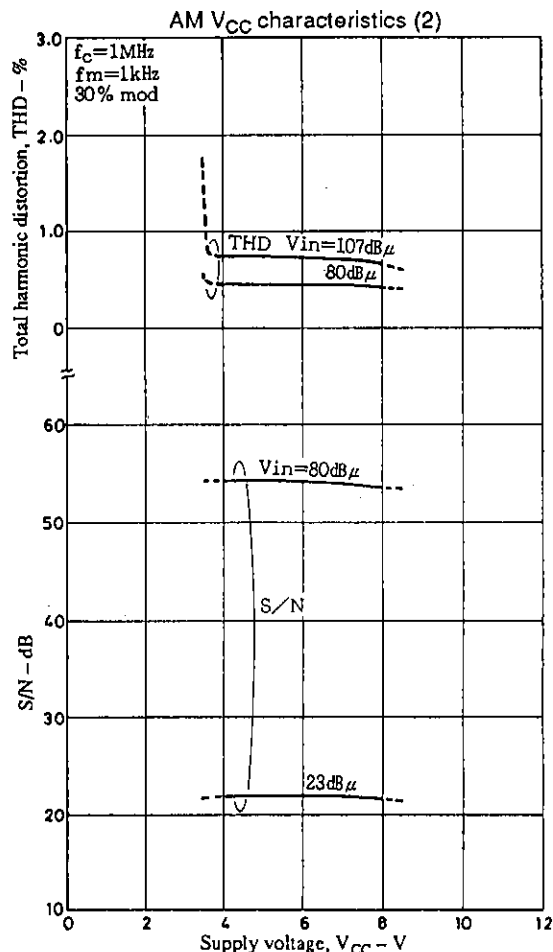
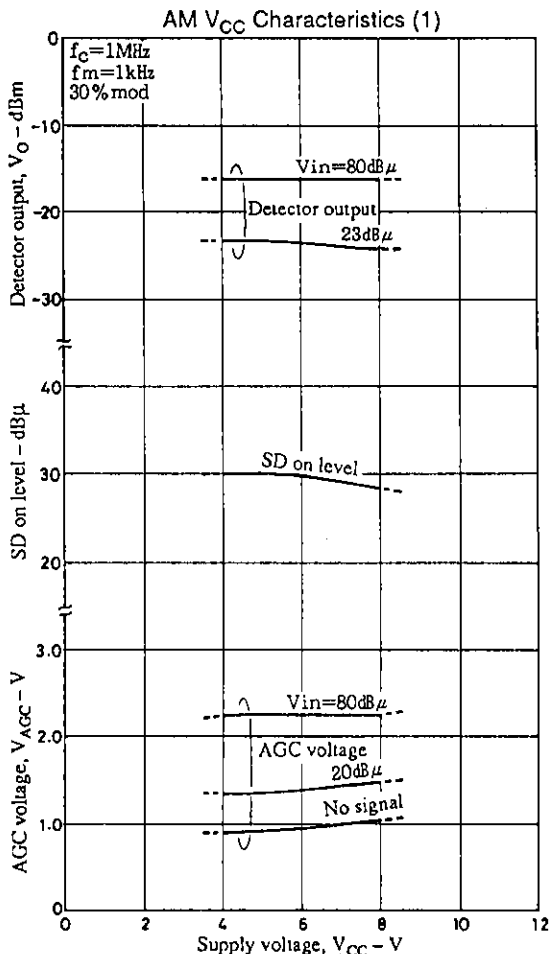

- No products described or contained herein are intended for use in surgical implants, life-support systems, aerospace equipment, nuclear power control systems, vehicles, disaster/crime-prevention equipment and the like, the failure of which may directly or indirectly cause injury, death or property loss.
- Anyone purchasing any products described or contained herein for an above-mentioned use shall:
 - ① Accept full responsibility and indemnify and defend SANYO ELECTRIC CO., LTD., its affiliates, subsidiaries and distributors and all their officers and employees, jointly and severally, against any and all claims and litigation and all damages, cost and expenses associated with such use;
 - ② Not impose any responsibility for any fault or negligence which may be cited in any such claim or litigation on SANYO ELECTRIC CO., LTD., its affiliates, subsidiaries and distributors or any of their officers and employees jointly or severally.
- Information (including circuit diagrams and circuit parameters) herein is for example only; it is not guaranteed for volume production. SANYO believes information herein is accurate and reliable, but no guarantees are made or implied regarding its use or any infringements of intellectual property rights or other rights of third parties.