

Specifications:

cable description	4 conductor (red, yellow, green, black), 0.16x7, aluminum foil shield (0.2x7)
receptacle overmold	black PVC
cable outer diameter	3.7
cable material	non UL 60P
cable color	black
cable gauge	AWG #26
cable length	1830
plug description	P/N 50-00007
twist tie	14 cm black
max voltage	300 V/S 0.5mA
max current	2 A

Notes: RoHS compliant

Mechanical drawing:

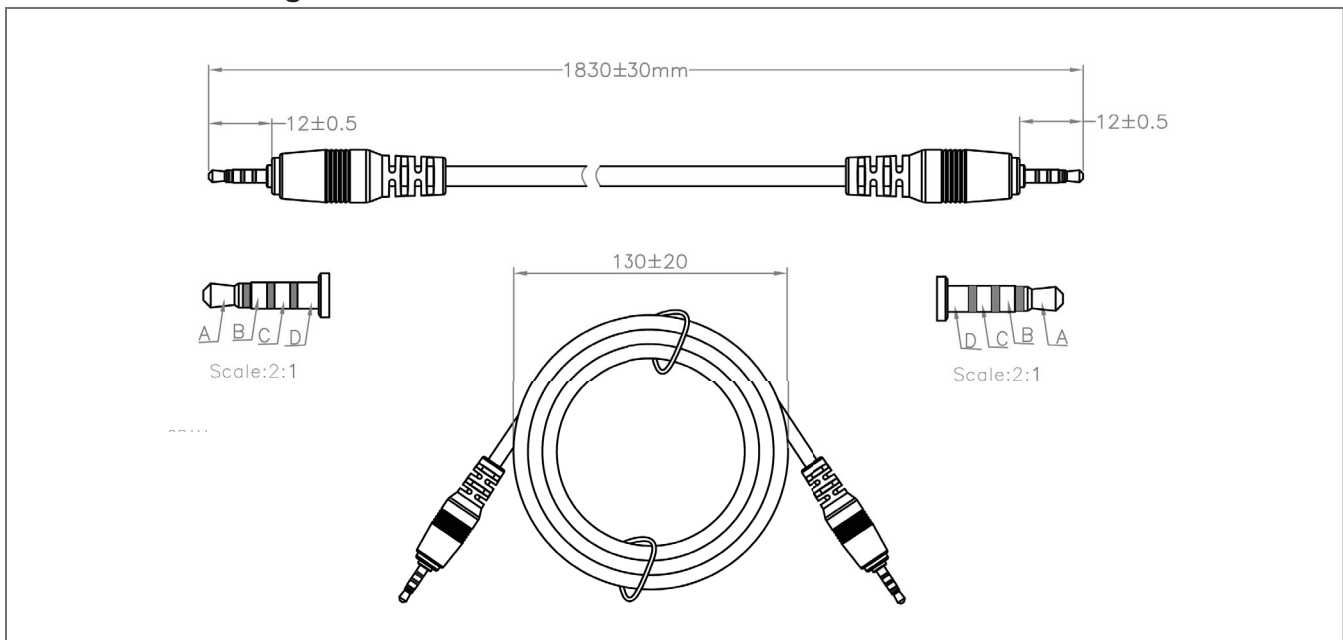

Wiring diagram:

A	Red Wire
B	Black Wire
C	Yellow Wire
D	Green Wire

tolerance .X: ±0.5 mm .XX: ±0.2 mm

Revision notes:

Rev	Date	Description
A	January 19, 2009	Re-issue. Original specification issued by CUI; re-issued by Tensility without any material or mechanical changes.
A1	May 11, 2009	added Tensility P/N 50-00007 to specification

tolerance .X: ± 0.5 mm .XX: ± 0.2 mm